

CPU Clock Generation Part 2

Bus Buffers & Controllers

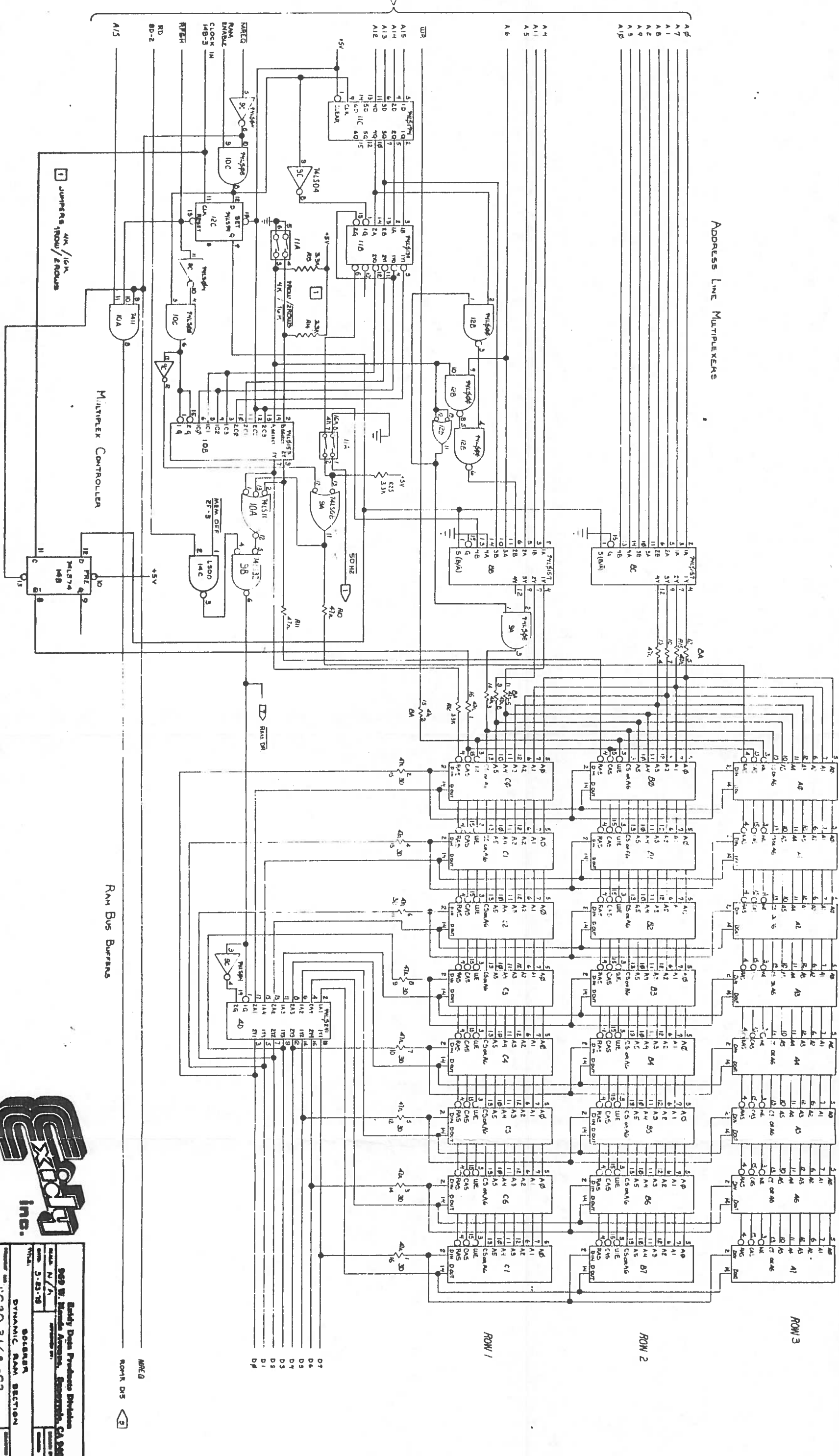

Model: V/A
 Date: 3-23-70
 Project: SONICRA Central Processing Unit
 Part: B 80 CPU
 Revision: SC30-5168-C2
 Sheet 5 of 11



NOTE 5:
 ① E104 OR EQUIVALENT IN 4K VERSION, 2116 OR EQUIVALENT IN 16K VERSION.
 ② EMPTY IN 4K AND 16K VERSION, E104 OR EQUIVALENT IN 8K VERSION, B16 OR EQUIVALENT IN 32K VERSION.



Circuit Dynamics Inc.
 Lucky Data Products Division
 969 W. Middle Avenue, Sunnyvale, CA 94086
 (415) 352-3168
 DYNAMIC RAM SECTION
 Model No. DC30-316B-C2
 Quantity of 11

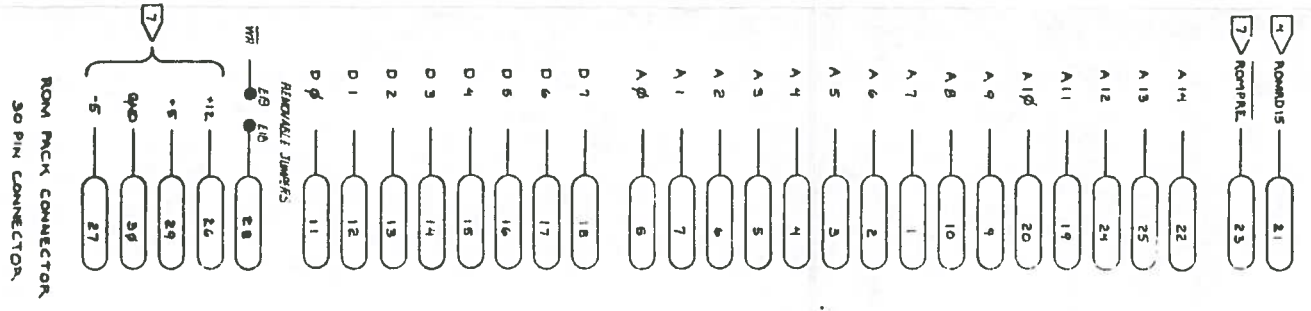
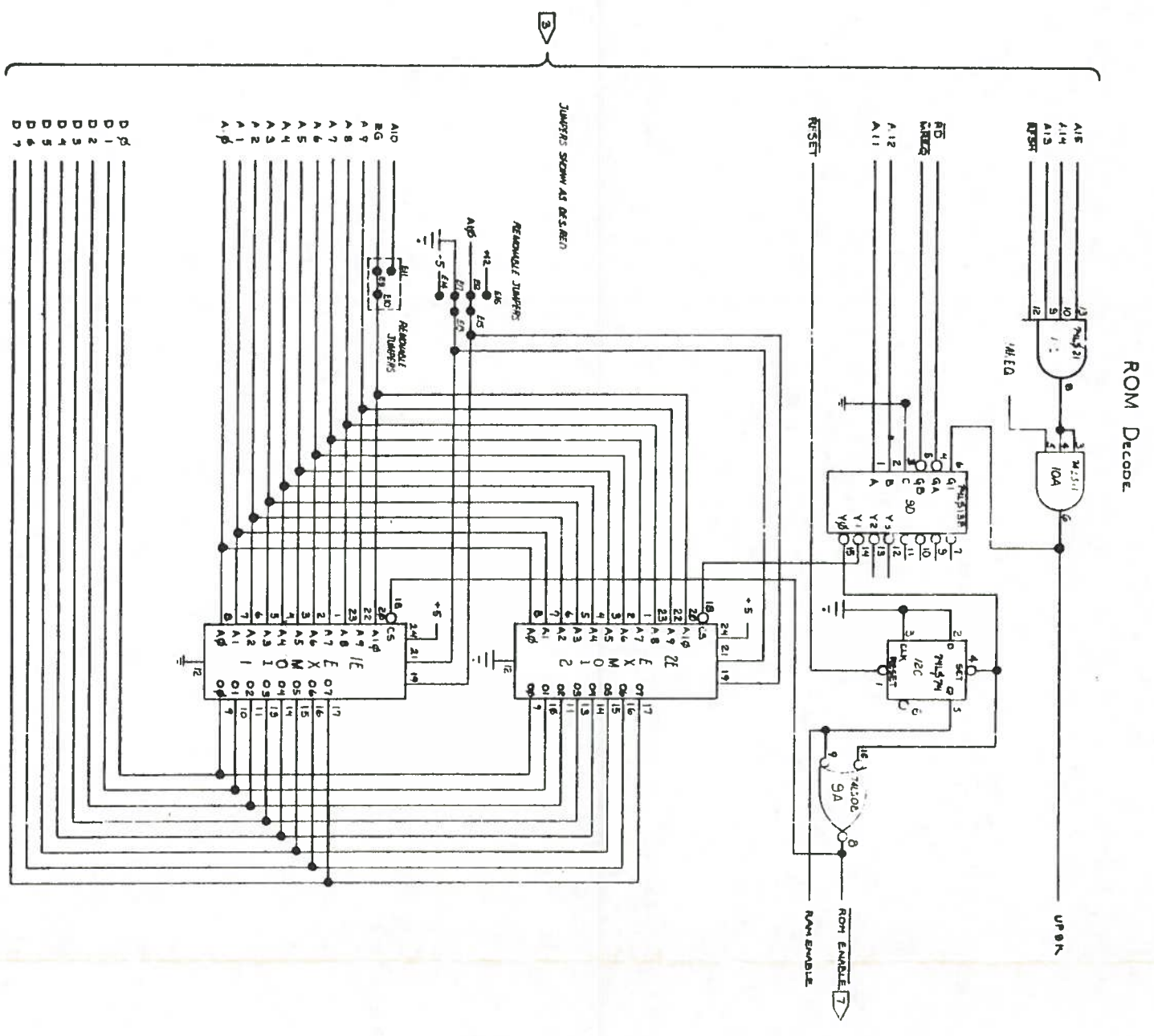

669 W. Menlo Avenue
 Redwood City, CA 94061
 Tel: 650-962-1100
 Telex: 152370
 FAX: 650-962-1111

ROM SECTION

5C30-916B-C2

Sorcera Input Port

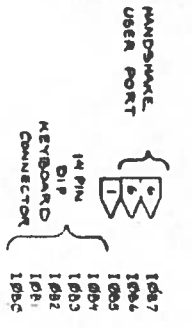

UART

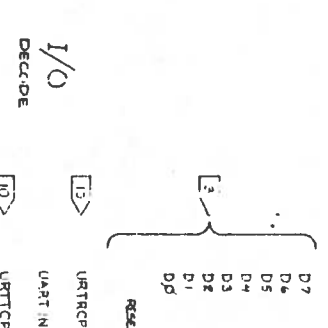

Sorcera Output Port

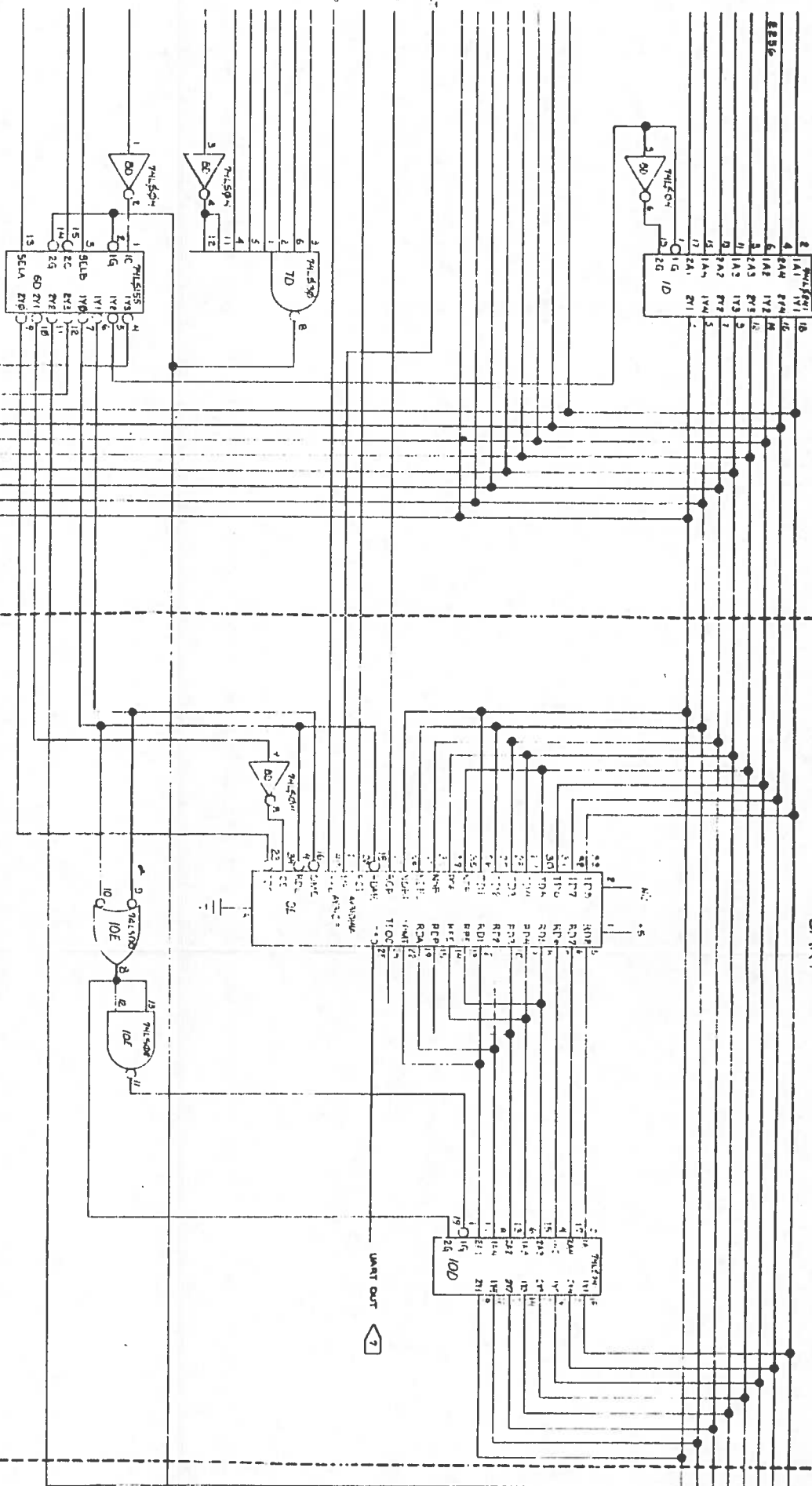
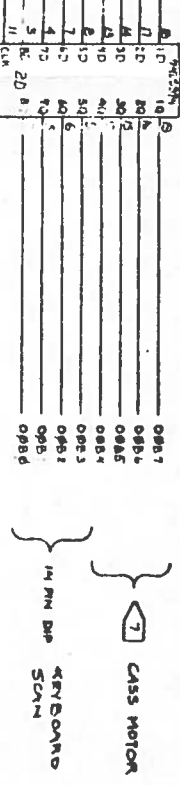

PARALLEL INPUT FFM

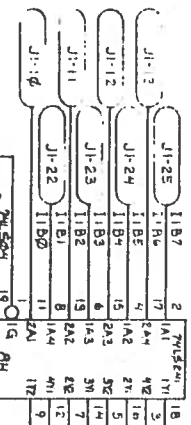

PARALLEL OUTPUT FFM

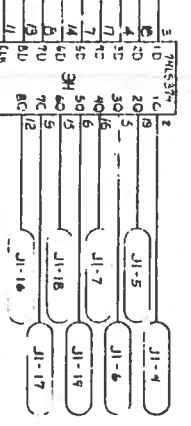

User Input Port

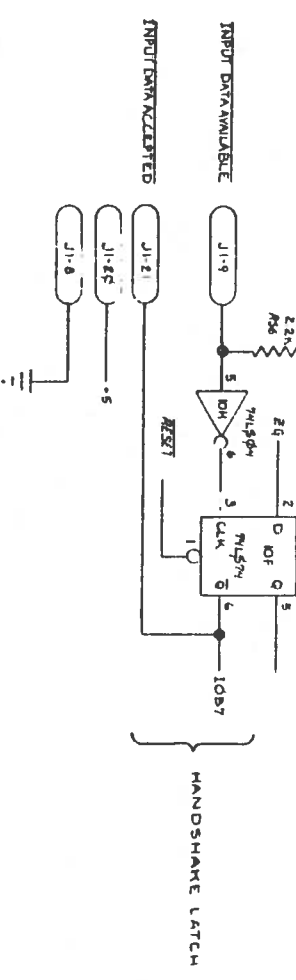

User Output Port

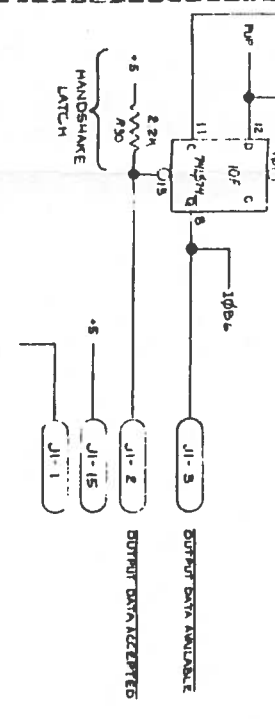

ES&I Inc.
 Entry Data Products Division
 999 W. Nevada Avenue, Sunnyvale, CA 94086
 (415) 335-2170
 FAX: (415) 335-2170
 I/O / UART
 SC30-916B-C2
 SHEET 6 of 11

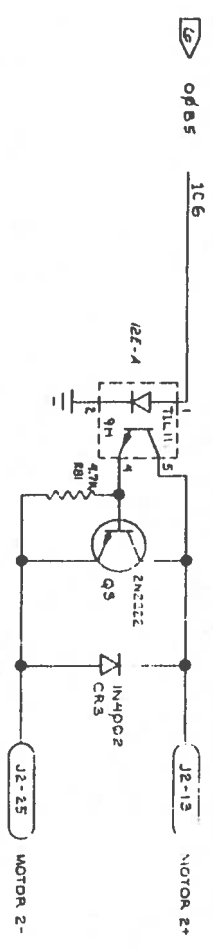
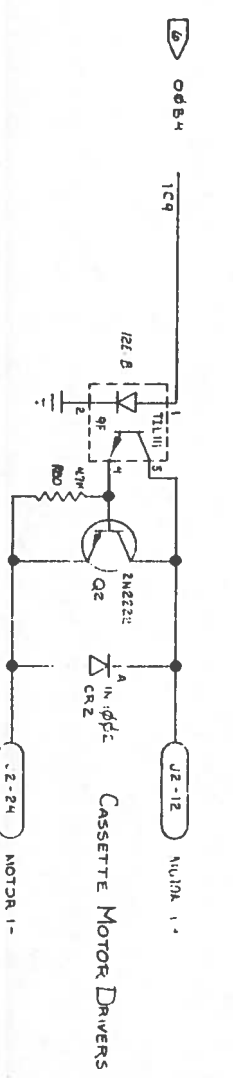
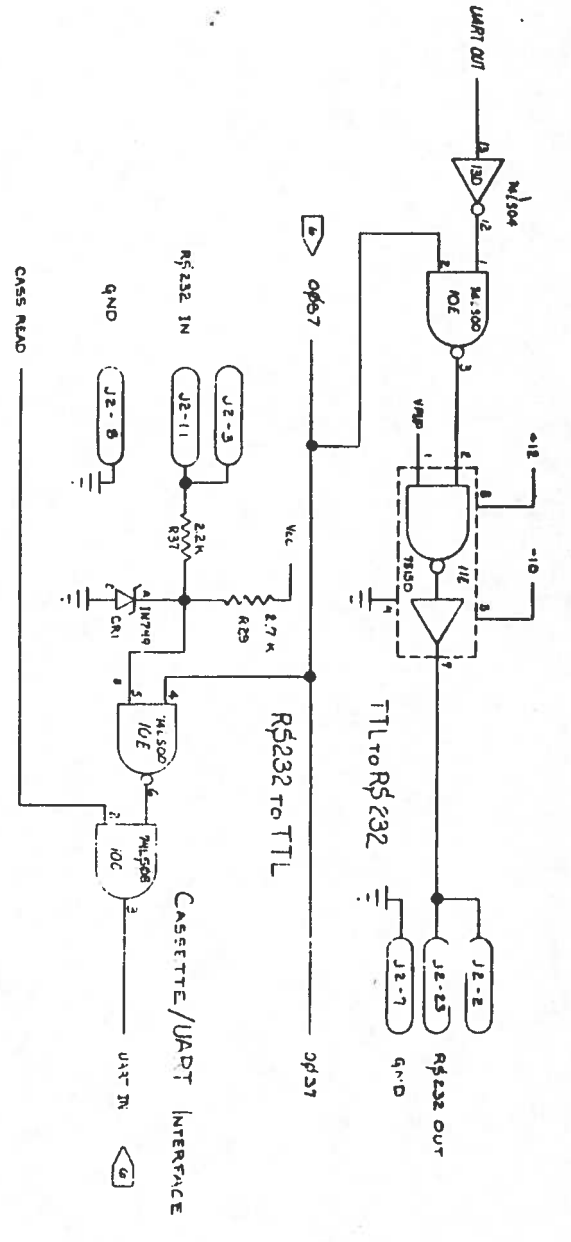

- PS-1 -10V
 - PS-2 -5V
 - PS-3 +12V
 - PS-4 +5V
 - PS-5 GND
 - PS-6 GND
 - PS-7 +5V
 - PS-8 +12V
 - PS-9 -5V
 - PS-10 -10V
- POWER SUPPLY CONNECTOR

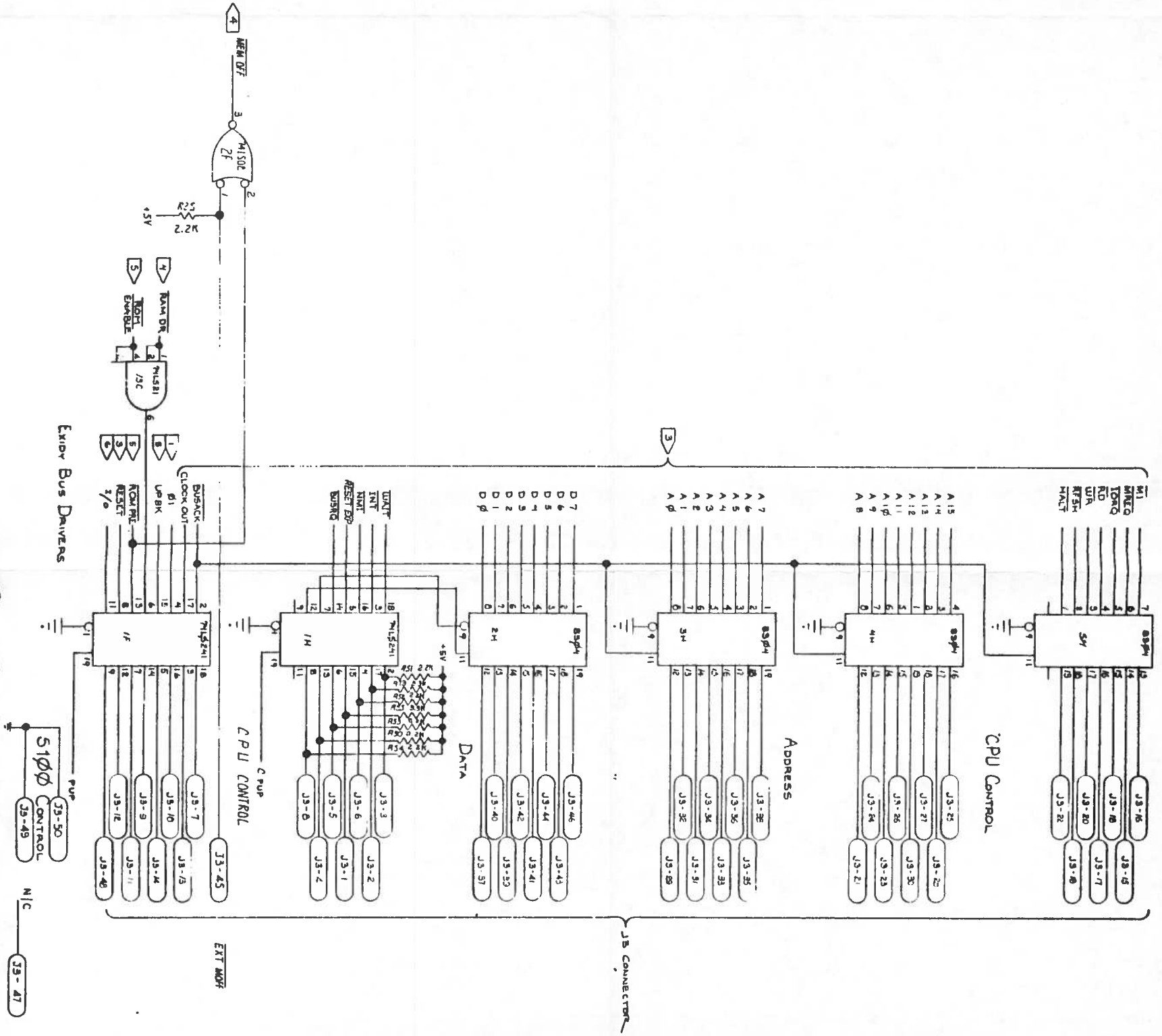

Circuit City Inc.
 999 W. Nevada Avenue, Sunnyvale, CA 94086
 408-735-1111
 INTERFACES
 SC90-9168-C2
 10/11

SERIAL DATA FROM UART

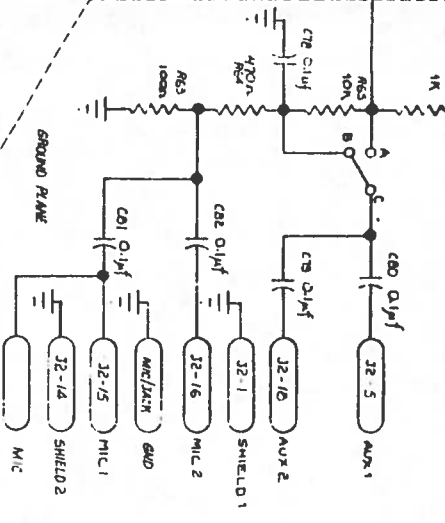
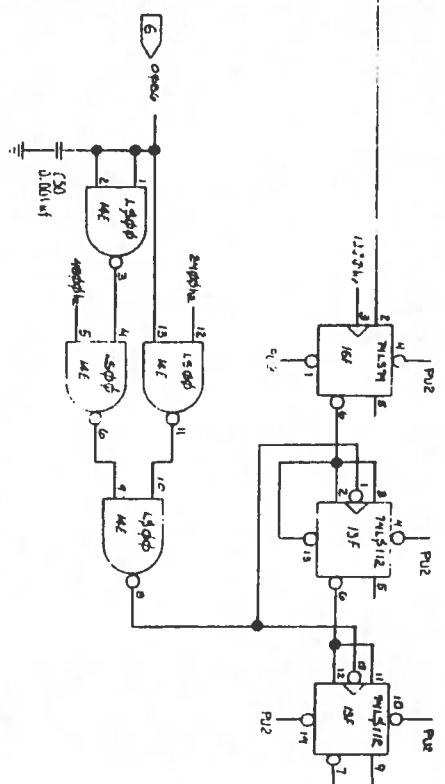
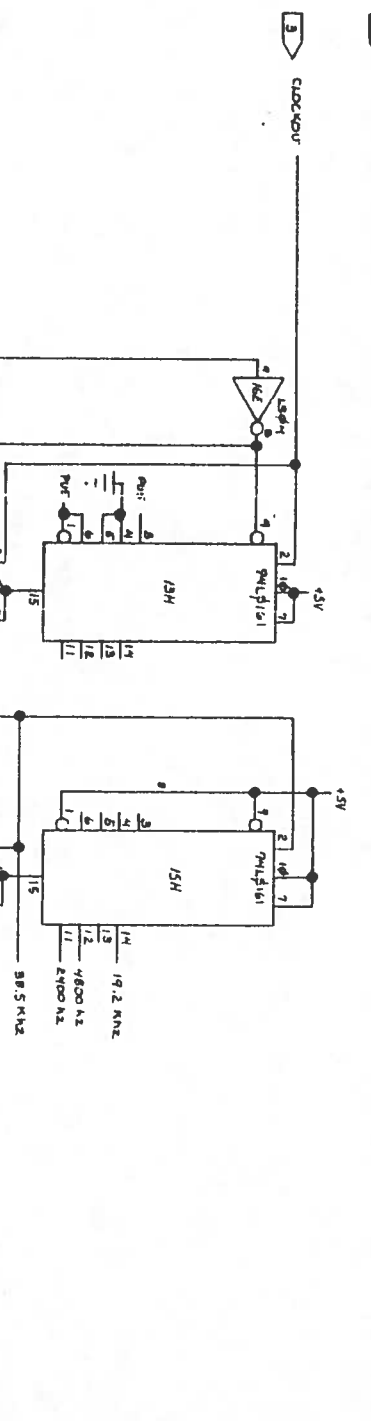

LOCATE AS CLOSE TO COMPONENT AS POSSIBLE

LOCATE AS CLOSE TO COMPONENT AS POSSIBLE

GROUND PLANE AREA

LOCATE AS CLOSE TO COMPONENT AS POSSIBLE

LOCATE AS CLOSE TO COMPONENT AS POSSIBLE

LOCATE AS CLOSE TO COMPONENT AS POSSIBLE

LOCATE AS CLOSE TO COMPONENT AS POSSIBLE

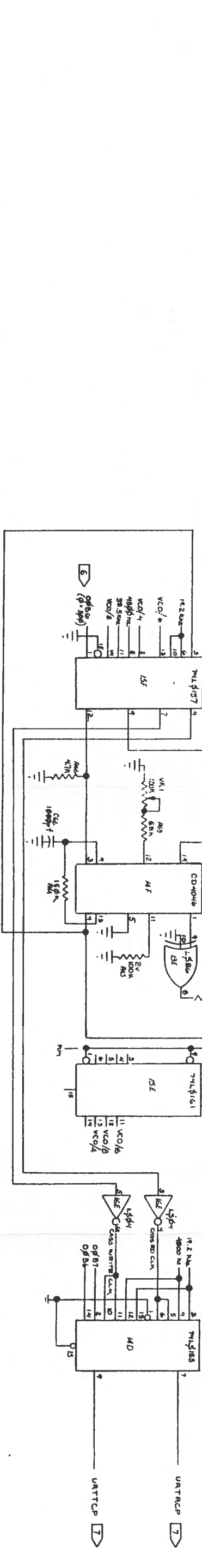

LOCATE AS CLOSE TO COMPONENT AS POSSIBLE



Circuit City Inc.
 Radio Shack Production Division
 999 W. Middle America, Des Moines, IA 50319
 Model # 3168-C2
 SC50-3168-C2
 Cassette Interface
 © 1978
 Printed in U.S.A.

REVISIONS		DATE	APPROVED
ZONE	LTR		

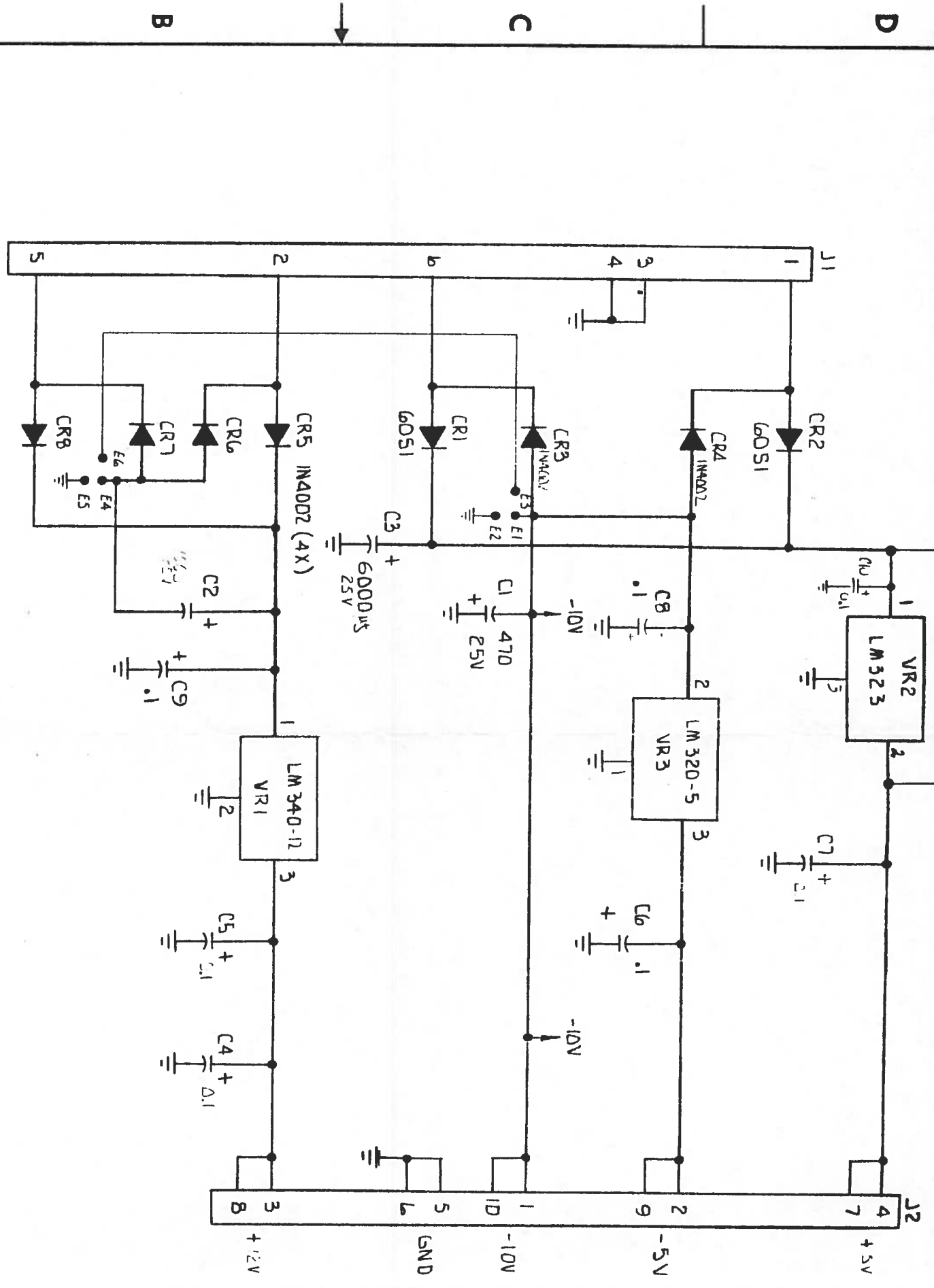

REFERENCE	DESIGNATION	DELETED
FIRST	LAST	DELETED
C1	C10	
CR1	CR8	
R1	R1	
VR1	VR3	
J1	J2	

QTY	CODE	PART OR IDENTIFYING NO.	NOMENCLATURE OR DESCRIPTION
RECD	IDENT		

UNLESS OTHERWISE SPECIFIED DIMENSIONS ARE IN INCHES TOLERANCES ARE:		CONTRACT NO.	
FRACTIONS	DECIMALS	ANGLES	
± .XX	± .XXX	±	
MATERIAL		DRAWN	APPROVALS
		BS	
		CHECKED	DATE
			7-19-79

FINISH	DO NOT SCALE DRAWING	SCALE	CODE IDENT NO.	DRAWING NO.
		C	30-0005-D	

NOTES: UNLESS OTHERWISE NOTED -
 1. ALL RESISTORS ARE IN OHMS.
 2. ALL CAPACITANCE ARE MICROFARADS.

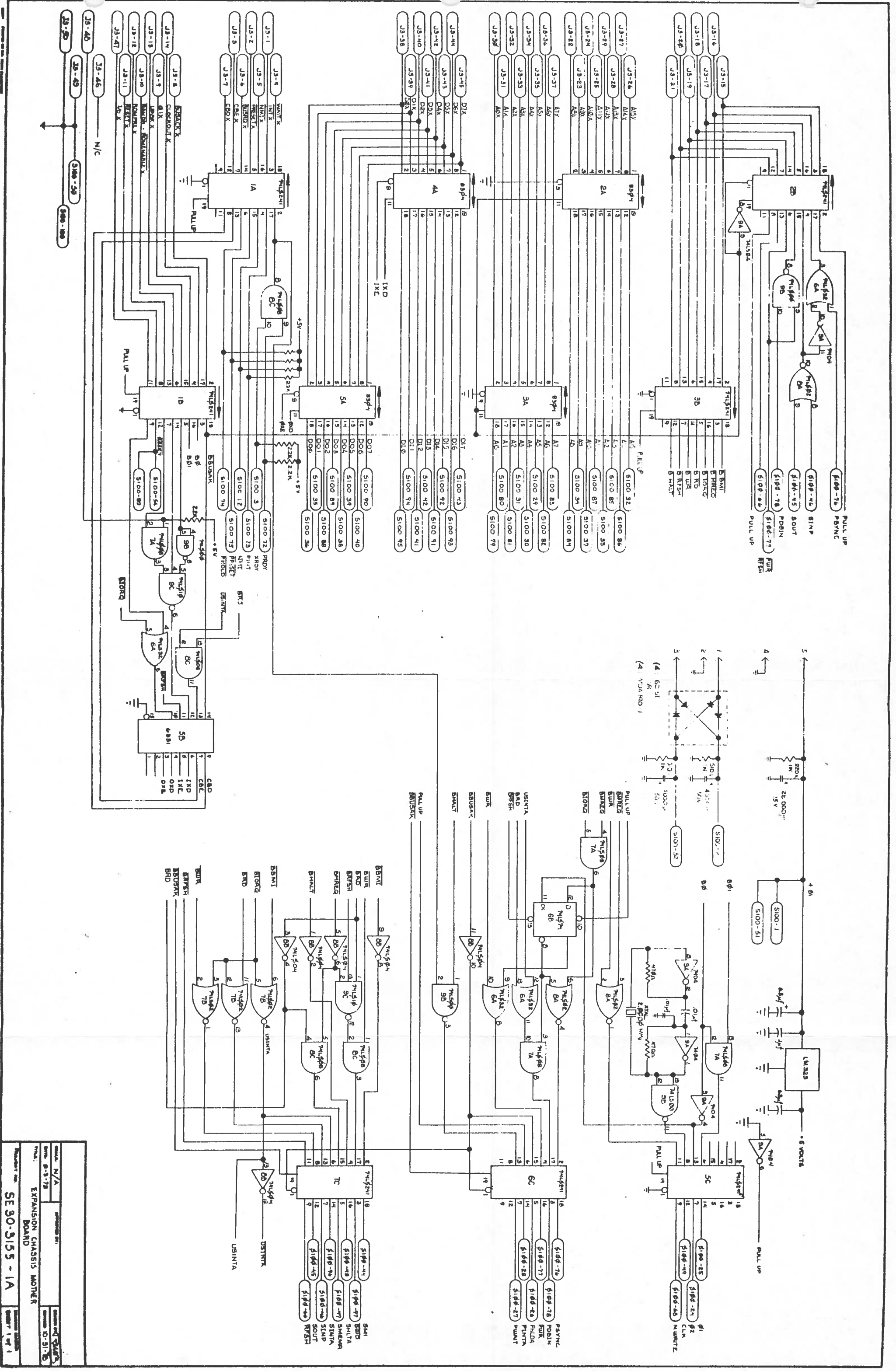

MODEL: N/A
 PART: 0-3-78
 EXPANSION CHASSIS MOTHER BOARD
 SE30-3155 - 1A
 SHEET 1 OF 1

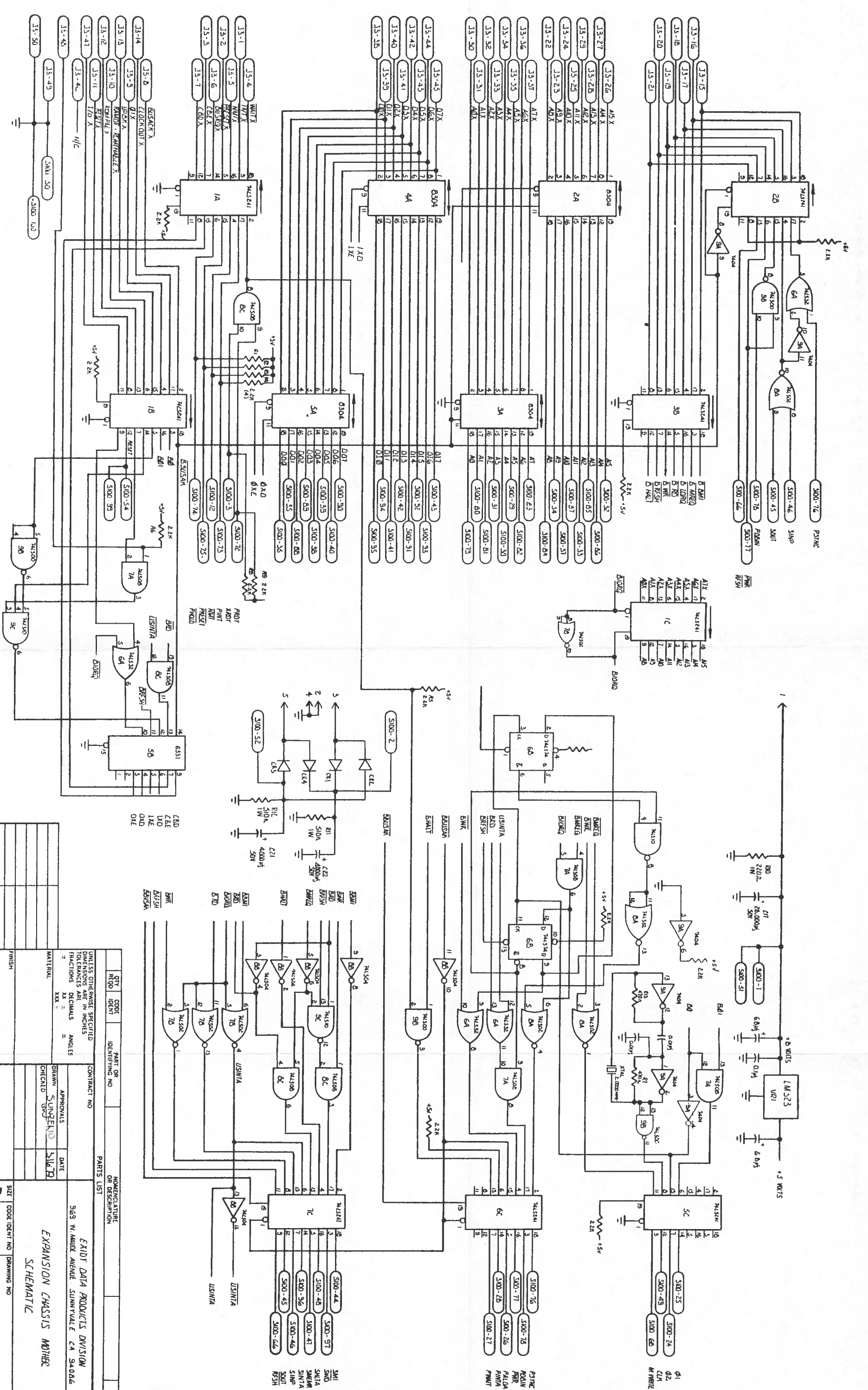

QTY	CODE	PART OR IDENTIFYING NO.	NONCUMENTURE OR DESCRIPTION
1	74LS04	74LS04	INVERTER
1	74LS10	74LS10	NAND GATE
1	74LS125	74LS125	MONOSTABLE MULTIVIBRATOR
1	74LS23	74LS23	DUAL MONOSTABLE MULTIVIBRATOR

CONTRACT NO. 963 W. MAUDE AVENUE, SUMMITVALE, CA 94066	
MATERIAL SILVER FINISH	DATE
APPROVALS DRAWN BY: SUNGER CHECKED BY: GRYB	

NEXT ASSY APPLICATION USED ON	DO NOT SCALE DRAWING
----------------------------------	----------------------

SIZE D SCALE 1/8"	CODE IDENT NO. 30-3155-1/B	DRAWING NO. 30-3155-1/B	SHEET 1 OF 1
----------------------------	-------------------------------	----------------------------	--------------

REV	DATE	DESCRIPTION	BY	CHKD
1	10-17-72	REVISED		
2	11-14-72	REVISED		

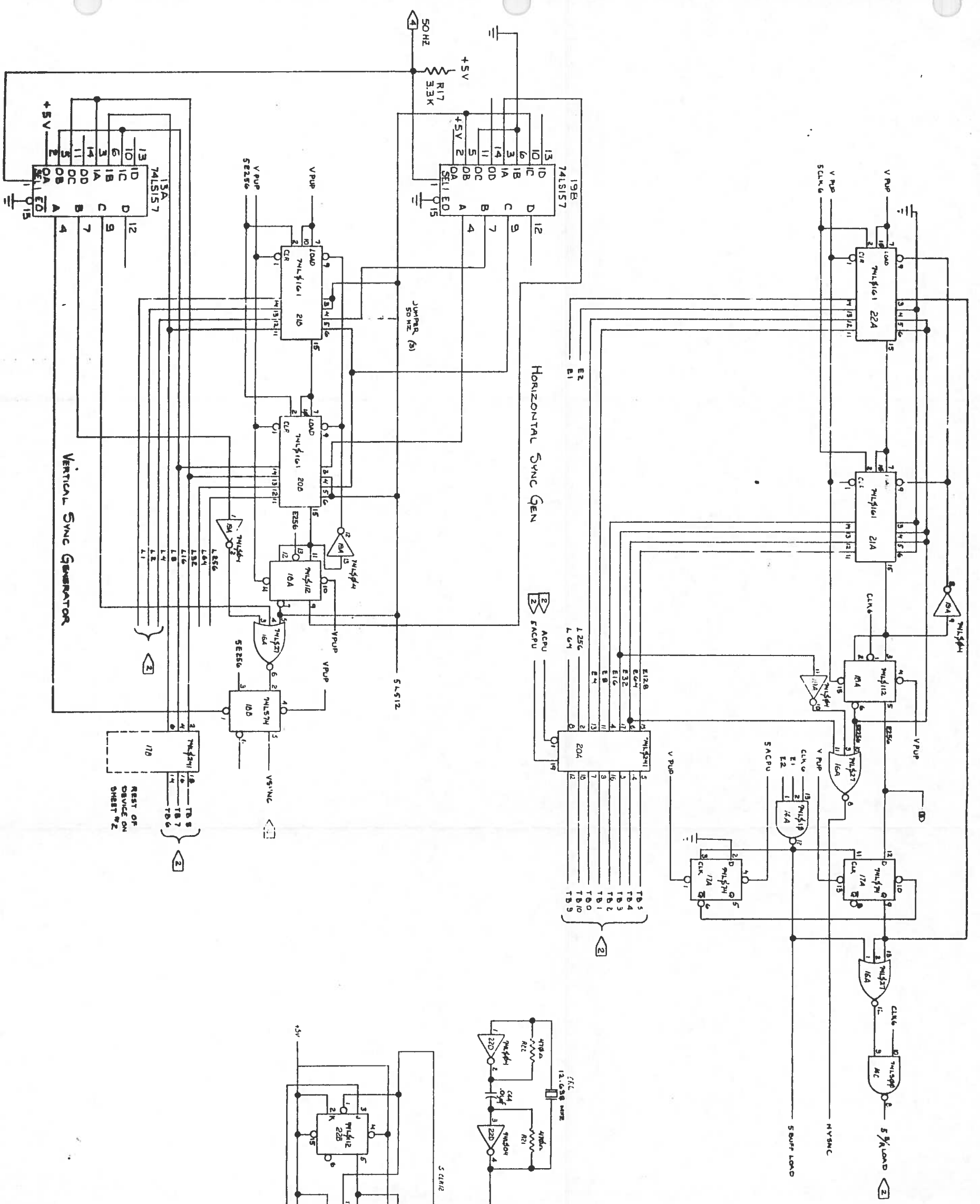

Project No. **SC30-316B-C2**

Sheet 1 of 11

Master Timing for BVDY STIMULCO VIDEO

Screen Address Multiplexing

