

North Star Background

---

North Star Market Focus

---

North Star Product Overview

---

North Star Product Details

---

North Star Policies and Procedures

---

North Star Marketing Support

---

North Star Technical Support

---

# Dealer Manual Update

DATE: October 23, 1981  
No. 01

North Star wants your Dealer Manual to work for you. Therefore we want to make it as easy as possible for you to keep your manual up to date and accurate. We are initiating with this mailing a formal update process which we will repeat as the need arises for corrections and/or insertions of new material.

Please take the time -- RIGHT NOW! -- to make the page insertions and deletions as described below. Also keep a look-out for future updates, which will always be accompanied by an instruction page just like this one.

## DELETE

1. Current "Contents" page.
2. "Product Overview," pages 3-11, 3-12, 3-14.
3. ~~Ø~~
4. "Product Details Introduction," page 4-1.
5. "Marketing Support," page 6-16.
6. "Technical Support," pages 7-7, 7-8, 7-9, 7-10.

## ADD

1. "Contents" page dated 10/81.
2. "Product Overview," pages 3-11, 3-12, 3-14, dated 10/81.
3. "Product Overview ADVANTAGE," pages 3-9A, 3-9B, 3-10A, dated 9/81.
4. "Product Details Introduction," page 4-1, dated 10/81.
5. "Marketing Support," pages 6-16, dated 10/81.
6. "Technical Support," pages 7-7, 7-8, 7-9, 7-10, dated 10/81.

# Dealer Manual Update

DATE: August 16, 1982

NO. 02

North Star has made many significant changes in our product lines: New Hardware products, Software products and pricing, as well as new Maintenance Policies. We want to keep your Dealer Manual up to date and accurate, reflecting these changes. This mailing contains the updates to your manual to bring it up to date.

Please take the time -- RIGHT NOW! -- to make the page insertions and deletions as instructed below.

## DELETE

1. Current "Contents" page
2. Section 3 - "Product Overview"
3. Section 4, Page 4-1, dated 10/81
4. Section 5, Page 5-3  
(Direct Dealers only: Page 5-4, 5-5, 5-6)
5. Section 6, pages 6-4, 6-5, 6-6, 6-7, 6-13, 6-14, 6-15, 6-16, 6-17
6. Section 7 "North Star Technical Support"

## ADD

1. "Contents" dated 8/82
2. Section 3 - "Product Overview"  
(pp. 3-1 to 3-17 dated 8/82)
3. Section 4, Page 4-1, dated 8/82
4. Section 5, Page 5-3, dated 8/82  
(Direct Dealers only: Page 5-4, 5-5, 5-6 dated 8/82)
5. Section 6, Pages 6-4, 6-5, 6-6, 6-7, 6-13, 6-14, 6-15, 6-16, 6-17, 6-17A, dated 8/82
6. Section 7 "North Star Technical Services" pp. 7-1 to 7-18 dated 8/82

# Contents

---

## How To Follow The Star

1. **North Star Background**
  - Past
  - Present
  - Future
2. **North Star Market Focus**
  - Introduction
  - Target Markets
  - Marketing Strategy
3. **North Star Product Overview**
  - Introduction
  - North Star Building Blocks
  - North Star Packaged Multi-User Systems
  - Pricing Summary
  - System Price & Capacity Analysis
4. **North Star Product Details**
  - Introduction
  - Suggested Retail Price List
  - Product Details
  - Product Reviews
5. **North Star Policies and Procedures**
  - Introduction
  - Contracts
  - Who To Call For Assistance
6. **North Star Marketing Support**
  - Introduction
  - Corporate Programs
    - Worldwide Advertising
    - Public Relations
    - Trade Shows
  - Dealer Programs
    - Dealer Newsletter
    - Training Seminars
    - Dealer Manual
    - Literature
    - Sales Leads
    - Direct Sales Support
    - Co-op Advertising
7. **North Star Technical Services**
  - Introduction
  - Levels of Service
    - North Star Factory Service
    - North Star Authorized Service Centers
    - Third Party Service
  - Description of Service Policies
  - Technical Support
  - Technical training
  - Administration
  - Appendices

©1982 North Star Computers, Inc. Contents of this publication may be changed without notice.

The North Star logo, HORIZON, NorthNet, FASTACK, and NorthWord are trademarks or registered trademarks of North Star Computers, Inc. CP/M is a registered trademark of Digital Research, Inc. ACCPAC is a trademark of Basic Software Group. Pascal II.O is an implementation of the U.C.S.D. Pascal System. Z-80A is a registered trademark of Zilog Corporation. COBOL and FORTRAN are implementations of systems written by Microsoft Consumer Products. MicroPlan is a trademark of Chang Laboratories. WordStar, SpellStar and MailMerge are trademarks of MicroPro International Corporation. dBASE II is a trademark of Ashton-Tate.

---



# 1 North Star Background

---

The story of North Star Computers, Inc. is one focused on commitment to success. Like other dynamic companies in fields of advanced technology, North Star was started by two engineers with a lot of shared experience, good ideas, and a product concept. Today North Star is a corporation of significant size whose broad range of microcomputer products enjoy an unequalled worldwide reputation for excellence. All this was accomplished in less than five years.



## The Past

---

Dr. Charles Grant and Dr. Mark Greenberg began their association at UC Berkeley, first as students, then as Co-directors of a National Science Foundation project. In the course of their work, they saw potential in microcomputer products and began developing their own. This effort produced North Star's first product... the Floating Point Board, an S-100 circuit board for high speed floating point calculations.

Propelled by the success of this product, they next developed the Micro-Disk System, the first economical, fully integrated, disk storage system complete with a Disk Operating System and BASIC programming language.

By 1977, North Star was an established supplier of S-100 bus products and recognized the need for a totally integrated microcomputer system. In 1978 the HORIZON® was introduced as a complete high performance microcomputer with integrated floppy disk memory and S-100 bus compatibility.

The success of the North Star HORIZON was phenomenal. The product itself reflected the company's product philosophy: engineering excellence, designed-in reliability, efficiency of operation and capability for expansion.

The unique design of the HORIZON and its universal acceptance set the stage for North Star's rapid development as a major microcomputer manufacturer.

---

## The Present

---

North Star today enjoys an enviable position in the industry. It is a well managed, financially sound company with an expanding family of hardware and software products, worldwide distribution, and a continuing commitment to provide the benefits of microcomputer technology to solve the problems of business, industry, and the education communities.

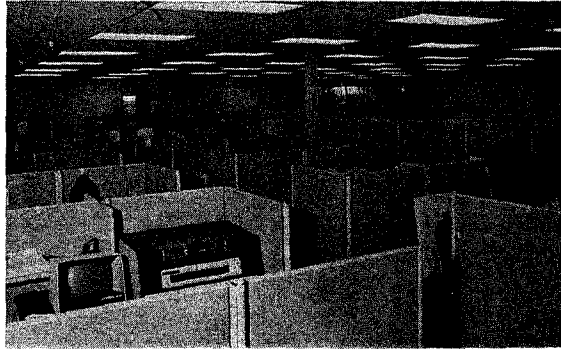

During its period of rapid growth, North Star, through careful planning and management, avoided the common pitfalls that have plagued many privately held high growth companies. It did so by focusing on issues of capitalization, costs of production and administration, profits, sensitivity to the needs of the marketplace, and ability to react to changes in the marketplace.

By instituting good management programs early in its development, North Star was able to maintain a sound financial base on which to expand. Today, North Star remains a high growth, privately held corporation with annual sales growing at a 67% compound rate with Net Profit After Tax of over 10%.

## The People Philosophy

---



One of North Star's most important commitments is to our employees, striving to create an environment where individual potential is realized and efforts are rewarded, even in a fast-paced highly competitive industry. A healthy working environment enables everyone to concentrate on and enjoy their work and participate as part of the team. Our modern 90,000 square foot plant offers pleasant, safe and prideful surroundings. Our incentive programs, personnel policies and extensive on site management training programs allow for personal and professional growth and a share in the company's success.

---

# The Product Philosophy

---

North Star products are designed to allow people in business, industry and education to solve problems quickly and economically. We offer a continually expanding line of microcomputer hardware and software products with a building block approach.

This North Star approach demands excellence in design, testing and manufacturing. Our products are designed to fill real needs, whether for a fast-access large-capacity data storage unit or an integrated set of accounting programs. Excellence in design to us means that our products not only set an industry standard for reliability, but they also are human engineered for ease of use. Our thorough testing procedures go further to assure that each product will deliver the reliability required for the business, scientific or education environment.

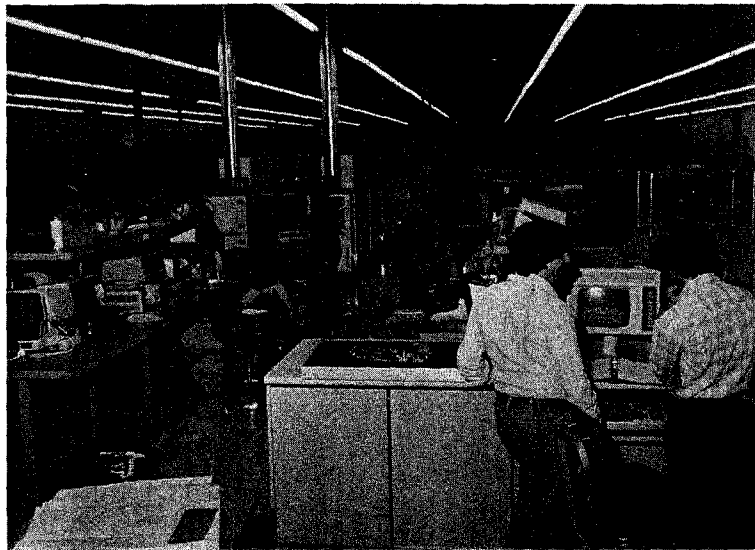

Our products build on themselves, from the basic HORIZON computer through additional hardware & software, expanding to fill the full range of microcomputer data processing and word processing needs. All with the North Star commitment to quality.

# North Star Support Philosophy

---

Our commitment doesn't stop at our shipping dock. As part of our continuing commitment to excellence in services, North Star has developed an Authorization Program for its Distributors, Dealers and OEMs all over the world. This overall program provides our distribution channels the tools they need for selling and supporting North Star products and systems. We provide sales and service training seminars, a Cooperative Advertising Program and several levels of service support as well as worldwide advertising, public relations and participation in industry trade shows.

At North Star, our service and support programs are combined with our people and products to give us a completely integrated approach to maintain our leading edge in the industry.

---

## The Future

---

North Star's objectives for the future are to build, together with our family of Authorized Dealers, upon our present success and realize continued rapid growth by penetrating today's highest growth markets. Our primary target market is that of small business data and/or word processing within small businesses or divisions of larger companies. Our secondary markets are the traditional computation-intensive applications within engineering/scientific labs, education institutions and industry.

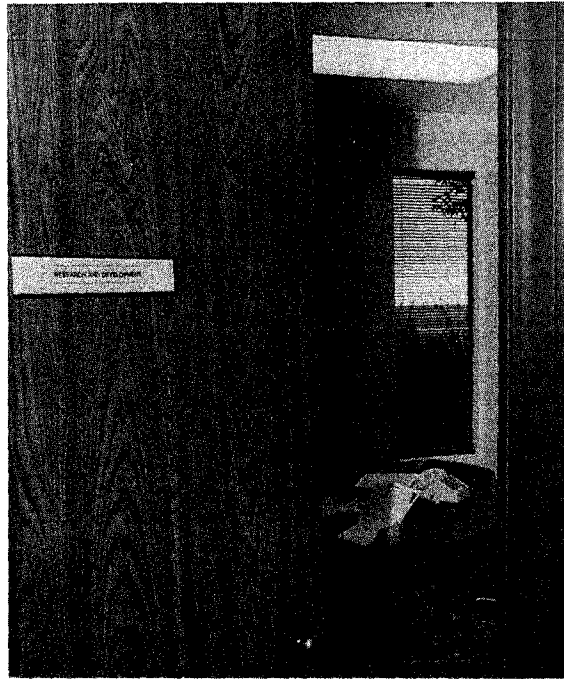

To accomplish these objectives North Star will:

- Continue to introduce leading edge innovative products that provide quality engineered economical solutions to the problems of business, industry and education.
- Continue to support and strengthen our distribution channels through unequalled levels of service and support.
- Continue to encourage and reward our most valuable asset... our people.
- Continue to expand our management development programs to assure sound judgment and good management of our expanding resources as we continue to grow.
- Continue development of our internal financial controls and management information systems to assure our management the information upon which to make sound decisions.

North Star is proud of its past and hard at work on its present in order to guarantee its future. We have met and will continue to meet our commitment to success through excellence of our people, our products, and our programs.



# Letter from The President

JULY 2, 1982

DEAR NORTH STAR RESELLERS:

I am writing this letter to all of you to discuss a number of significant issues relating to our distribution channel, our products, and our company.

As North Star has grown in size, much of the personal contact I have had with customers, both new and old, has diminished. I believe that a company - its employees and its customers, is very much like a family. The financial ties replace the blood ties, but the overall satisfaction is very dependent on the success of the people relationships. To retain this family relationship, I and other members of the executive staff will be periodically discussing significant issues in our own words in our various company publications.

Our Products. North Star was built on a foundation of innovative, cost-effective and reliable products. The integration of both hardware and software into complete systems has been a trademark. You have read about and seen at the NCC and Comdex some of our newest offerings: Networking, the under \$5,000 Advantage with hard disk, the Advantage 16-bit upgrade, dBase II, Enhanced WordStar and Enhanced MicroPlan.

More than our track record, you as extensions of North Star's sales effort need to know the future -- what are we planning and where are we heading, so you can understand how best to do your own planning.

Overall, North Star is committed to offer continually enhanced capabilities at the best price. As you have seen in the past, we have always offered more features and function in each new product, and we plan to continue that strategy. Over the near term, you can look for announcements relating to enhanced graphics software, communications capabilities, additional options in storage capacities, and expansion of our small business applications packages.



North Star Computers, Inc. 14440 Catalina St., San Leandro, CA 94577

Just as importantly, we are committed to continue the support of our significant existing product lines. In the case of Advantage that is obvious with the 16-bit upgrade, 5Mb hard disk and network products. But what about the Horizon and ASP applications?

Horizon. The Horizon product was North Star's first complete computer system, and, with the continued hardware and software enhancements, is still a highly competitive product and a significant portion of our sales. The Horizon is heavily used in both multi-user applications and applications where S-100 expandability is key. North Star will continue to support the Horizon with additional disk storage options, connectability to NorthNet, and other products.

ASP Applications. North Star has made substantial investments in our line of small business application packages, and we are very pleased to date with the success of that line. We are now planning to increase our promotion of the merits of this software. As many of you are aware, our Application Development System (ADS) has been in use by systems houses for over a year, and many new, compatible applications are on the verge of availability. North Star will publicize these packages to you. And, we will be both upgrading and expanding the line, including assuring operation with NorthNet.

Our Distribution. As the product offerings from the myriad of companies now planning to produce microcomputers expand, the importance of the reselling distribution channel increases. I want to describe how our distribution works and what our plans are.

North Star uses what is known as 2-tier distribution. That is, we sell either directly to our reselling customer (computer stores and systems integrators), or sell to them indirectly through a stocking distributor. We also sell directly to other large volume customers who cannot be best served by our distribution channel, such as large resellers who may have their own sales force direct to end-users.

Retail Stores and Systems Integrators. First, the bulk of North Star product is sold to the end-user either through a retail dealer with a storefront, or by a systems integrator, who typically operates out of commercial office space. Retail stores and systems integrators will buy either from a distributor or directly from North Star, depending on their volumes, their ability to predict their product needs, and their need for local support.

Domestic Distributors. North Star has assembled a team of regional distributors that span a large percentage of North America. Typically, a regional distributor has a broad knowledge of North Star products - both technical and sales-oriented, and can help the smaller retail store or systems integrator grow

their business. In areas where our regional distribution does not have sufficient coverage, they are supplemented through a National Distributor, such as Hamilton-Avnet. As the largest electronics distributor in the United States, Hamilton-Avnet can provide product availability and support through their large network of sales offices and warehouses.

International Distribution. Internationally, our make-up is very similar to the domestic side, with the obvious exception that there are added requirements of our international customers based on distance from the factory and language translation requirements. North Star has shown its commitment to the international business by seeking the required international standards approval such as VDE and CSA, and by recently announcing the development of a European manufacturing and marketing support facility.

Other. Perhaps the best example of the "other" category is General Binding Corporation. General Binding sells North Star products directly to end-users under the GBC name through their world-wide sales force.

Mail Order. Mail order does not fit into our distribution plans. Please don't do it. Mail order damages the end-user by failing to offer proper support. We do not have the legal and financial resources to fully blot it out, but we are doing our best to prevent it. We want our end customers to have excellent local support from the selling dealer.

The North Star strategy is to maintain our current distribution concept, as is, and to increase its number and strength.

Overall. I see that the primary areas of focus for North Star right now are related to meeting product delivery schedules and to marketing support: technical support, sales support, regional training, and sales leads. This is what you have been telling us, and this is what we have been working on. We have established an internal theme: "North Star is the easiest micro-computer company to deal with." You've heard of user-friendly software -- well, North Star is going to be known as the "dealer-friendly company." You will see this in our responsiveness to your problems, our product delivery scheduling -- all aspects of dealing with North Star. And, if we are not achieving this over the next few months, I want to hear from you about it.

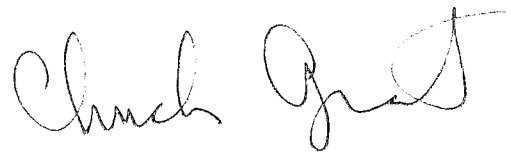

# 2 Market Focus

---

## Introduction

There are over 28,000 North Star HORIZON systems in use worldwide as of June, 1981. Many of these systems are performing computation-intensive applications in engineering or scientific laboratories within industry or educational institutions. A large number are also being used for special dedicated applications such as instrument control or telephone monitoring within products sold by a variety of electronics device manufacturers. Another large user segment is the computer professional who practices his or her profession at home using a low cost high performance HORIZON. However, since the introduction of Quad capacity floppy disk drives in 1979, the HORIZON has become primarily used for small business data and/or word processing applications.

The combination of a high-performance, easy to use and extremely reliable Z80 based S-100 bus computer integrated with Quad capacity 5¼ inch floppies and a very powerful disk operating system and a BASIC programming language has established the North Star HORIZON as the clear leader over its competition. In fact, we believe there were more HORIZONS shipped in 1980 than the total shipments of any other S-100 bus system supplier for that year.

The primary means of selling HORIZONS to this diverse user base has traditionally been the Retail Computer Dealer. These Dealers are currently in a transition from providing microcomputers for home use and a wide variety of general purpose applications within industrial and educational institutions to data and/or word processing applications within the small business community. This latter marketplace is emerging as the clear winner in terms of total size, estimated growth and opportunity for this distribution method.

For North Star to accomplish our growth objectives and help you, the Dealer, accomplish yours, both of us must now establish a **Target Market** on which we will focus our market and product development programs. Although we establish this **Target Market** as a strategic focal point, we must continue to aggressively pursue sales of North Star products within important secondary markets where we have traditionally been so successful.

This section briefly describes North Star's primary **Target Market**, its estimated population and total revenue potential as well as our secondary markets and the corresponding marketing strategy for penetrating these markets.



## 2 Market Focus

---

# Target Markets

## Primary Market

North Star's primary **Target Market** is first or second time data processing and/or word processing users within small businesses as defined below:

- Small owner operated businesses with under 20 persons and under \$5.0M annual sales.
  - Accounting applications that provide management information.
  - Office support applications that increase productivity.
  - Light to medium duty word processing applications.
- Small offices (stand-alone or as part of larger businesses) with under 20 persons.
  - Word Processing Applications.
  - Office Support Applications.
  - Accounting Applications.
  - All of which increase productivity.
- Larger businesses or offices requiring a specialized application or set of functions to which the North Star system is dedicated, thus providing either specific productivity increases or specific management information.
- Market Potential
  - Retailers 1.2 Million
  - Business Services 300,000
  - Professional Services 600,000
  - Wholesalers 200,000
  - Manufacturers 200,000

**TOTAL 2.5 Million Businesses**

## 2 Market Focus

---

### Target Markets

#### 2.5 Million Businesses...Total Market Potential

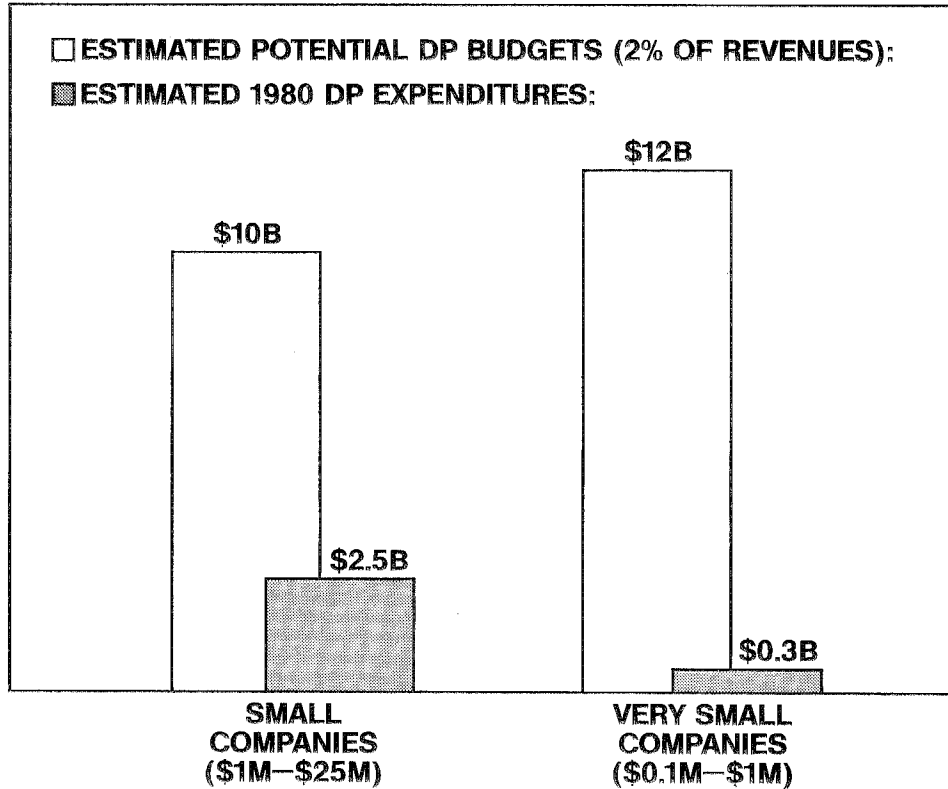

### Secondary Markets

North Star's secondary markets are those in which our products have been traditionally successful due to their high performance, ease of use, and high reliability. These secondary markets are:

- Education Market (including both high schools and universities)
    - Computer Science or Math Labs
    - Physical Science data collection and analysis
    - Scientific/Engineering Computation Applications
    - Business Administration Departments
  - Industrial Market
    - Engineering
    - Dedicated specialized data acquisition or control applications
    - Computation-intensive requirements
    - Program Development
-

# 2 North Star Market Focus

---

## Marketing Strategy

North Star Marketing Strategy is to create a high level of end user awareness of North Star as a quality-engineered, small business system supplier through worldwide advertising, public relations and trade shows coupled with the development of a successful, well supported Authorized Dealer family that identifies, sells and supports these end customers. We have also developed a network of Authorized Distributors who can provide smaller Dealers with additional benefits in the form of local available inventory, service support and personalized credit arrangements.

In order to reach as many as possible of the 2.5 million potential customers, North Star will continuously work closely with its Dealer family to help compete for the attention of these prospects. North Star has developed a broad marketing program designed to create end user demand for and confidence in North Star products and help you identify prospects, define and meet their needs and support them after installation. Some of the elements of this program are listed below and all are explained in detail within this Manual.

- Leading Edge Hardware and Software Products Integrating the Latest Evolving Technology Section 3  
Section 4
- Dealer Margins Section 4
- Worldwide Ad Campaign Section 6
- Sales Lead System Section 6
- Sales Literature Section 6
- Point of Sale Displays Section 6
- Trade Shows Section 6
- Dealer Newsletter Section 6
- Cooperative Advertising Program Section 6
- Direct Sales Support Section 6
- Dealer Training Seminars Section 6
- Service Policy Section 7
- Warranty Policy Section 7
- Dealer Hardware/Software Hot Line Section 7

# 3 North Star Product Overview

---

## Introduction

The **Primary Target Market** for North Star Computers, Inc. is defined in the previous section to be Small Business applications or Office Support applications within small companies. In order to serve this market successfully, hardware and software products must have certain specific characteristics.

**Hardware must be:**

- Reliable
- Expandable
- Easy to use

**Software must be:**

- Reliable
- Expandable
- Easy to use

The hardware and software must integrate smoothly into a system without sacrificing either's specific characteristics.

The resulting system must provide the end user with **four** clear, well-defined expansion paths so that at all levels of growth the user is insured against being "dead ended".

- Expand the **input capacity** (multi-user).
- Expand the **storage capacity** (large capacity shared disk storage).
- Expand the **applications capacity** (broad range of application software that works at all hardware levels).
- Expand the **output capacity** (range of available printers and the ability to use multiple printers).

North Star provides the following building blocks that combine into systems that meet these expansion requirements:

North Star Building Blocks:

- Computer Systems
  - HORIZON®
  - North Star ADVANTAGE
  - North Star ADVANTAGE 8/16
  - NorthNet™
- Software
  - Operating Systems
    - Single User
    - Multi-User
  - North Star Application Software Family
  - CP/M® Family
  - Programming Languages
- Boards and Peripherals
  - HRAM
  - Disk Drives
  - Matrix Printers
  - Letter Quality Printers

# 3 North Star Product Overview

## North Star System Building Blocks

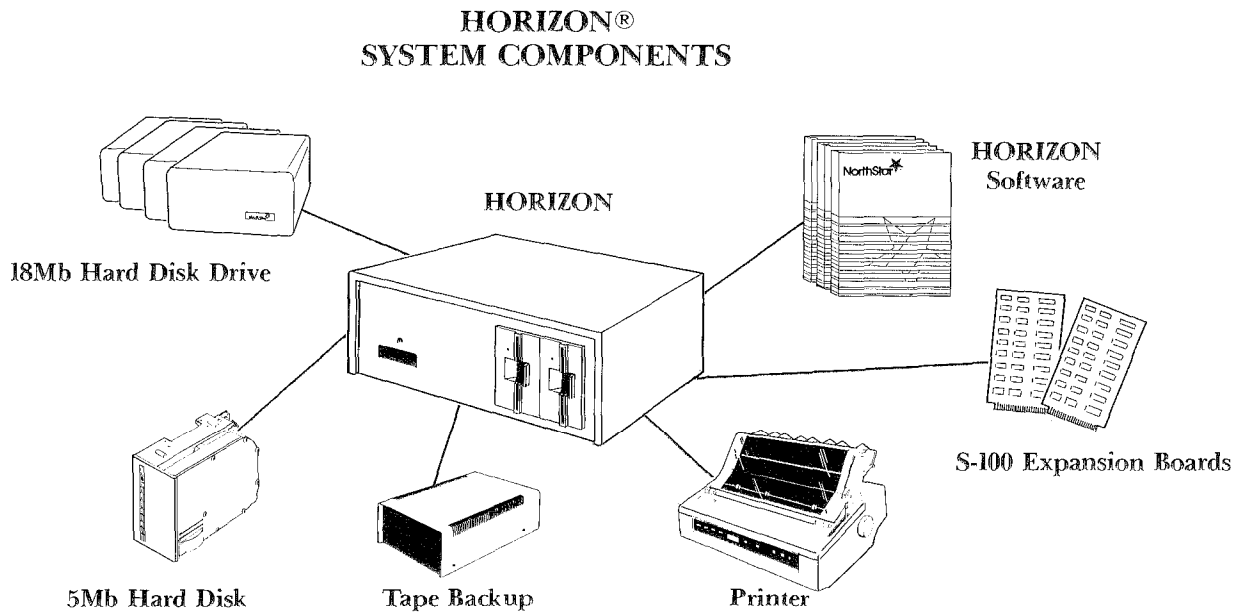
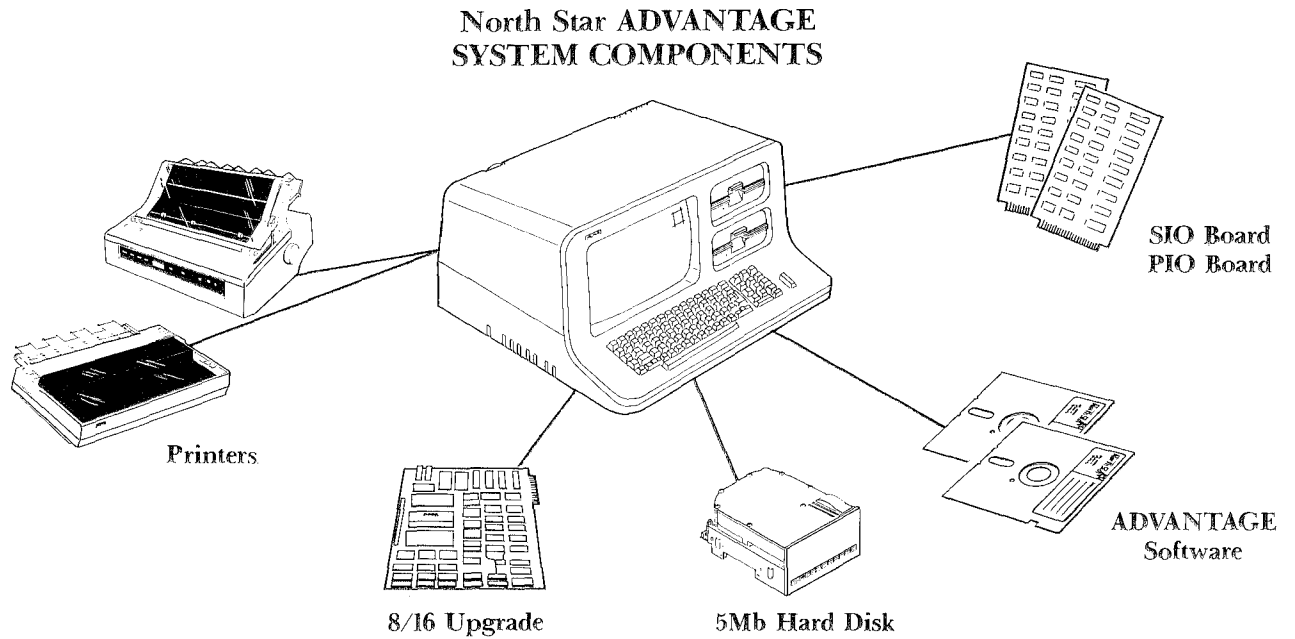

# 3 North Star Product Overview

---

## North Star Computer Systems

The exciting integrated graphics computer — The North Star ADVANTAGE.

### ADV-2Q-64K

- Powerful Business Graphics software and end user-system diagnostic package supplied with each system.
- Supported by the following North Star system and application software options:
  - Application Software Products
  - Graphics DOS/Graphics BASIC
  - Graphics CP/M
  - BUSIGRAPH
- Attractive integrated desk top package.
- 12" non-glare display that operates in *character* mode (80 characters by 24 lines) and *bit mapped graphics* mode (640×240 pixels).
- Z-80A® with 64K Dynamic RAM with parity.
- Two Quad Floppy Disks (720Kb).
- 2K prom for initial program load.
- 20K Dynamic RAM for display support.
- 87-Key Selectric style keyboard, including 15 programmable function keys and 14 key numeric/cursor control pad.
- 6 I/O bus slots for optional serial or parallel ports.  
(1) RS-232 C serial port supplied with standard system.

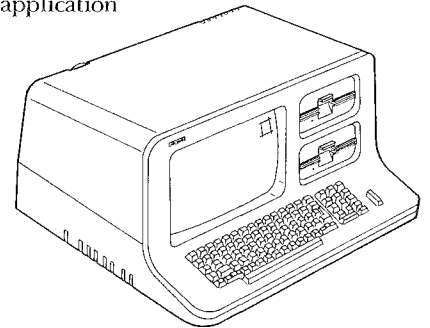

### ADV-1Q-64K-HD5

- Same as ADV-2Q-64K except there is one quad capacity Floppy Disk (360Kb) and one 5Mb Hard Disk.

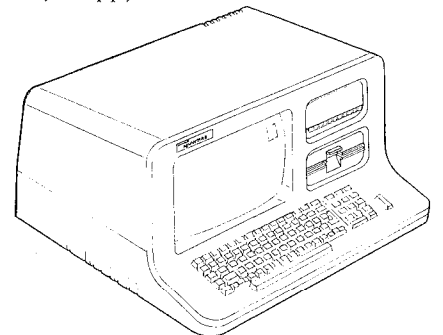

# 3 North Star Product Overview

## North Star Computer Systems

We have extended the North Star ADVANTAGE with two brand new upgrade paths — ADVANTAGE 8/16 featuring 8 or 16 bit co-processing and NorthNet™ providing a low cost, proprietary Local Area Network.

### ADVANTAGE 8/16 Option

- A low cost upgrade kit to existing North Star ADVANTAGE.
- Combined 4MHz Z-80A and 8MHz Intel 8088 microprocessors each with 64K memory.
- 8088 memory expandable to 256Kb.
- Available (like North Star ADVANTAGE) with dual 5¼" floppy disks (720Kb total) or one 5¼" floppy disk (360Kb) and one 5¼" Hard Disk (5Mb).
- Runs all GCP/M, GDOS and North Star ASP software of the standard North Star 8-bit ADVANTAGE.
- Runs applications software compatible with 16-bit MSDOS.
- Emulates IBM PC operating attributes.
- Reads floppy disks compatible with either North Star ADVANTAGE or IBM PC.
- Full North Star ADVANTAGE Graphics features supported in 16-bit mode.

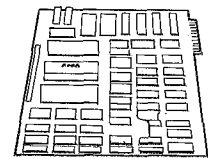

### NorthNet™

A Low Cost Network for sharing disks, printers and other resources, plus electronic mail.

### NorthNet™

- Links North Star ADVANTAGES or ADVANTAGE 8/16s together for sharing disks drives, printers and gateways, plus electronic mail, all inexpensively.
- Interconnect up to 64 workstations or resources with low cost twisted pair cable (up to 10,000 ft.) 1 Mbit/sec bandwidth. CSMA/PA protocol. FASTACK™ message acknowledgement scheme.
- Simple installation of both hardware and software.
- Easily configured by the user.

### Workstation Board

- Simple plug-in board converts a North Star ADVANTAGE into a workstation on the network.

### Server Board

- Simple plug-in board upgrades a North Star ADVANTAGE workstation into a server. A server handles the sharing of the disks, printers, etc. with the other workstations on the Network.

### FASTACK™

- Proprietary message acknowledgment technique — effective throughput increases 50 to 60%.

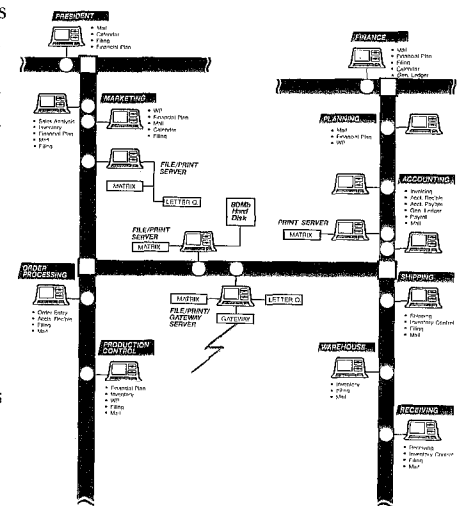

# 3 North Star Product Overview

---

## North Star Computer Systems

North Star has developed the HORIZON® Product Line to meet these expansion requirements by evolving a series of System Building Blocks. Each new hardware or software product builds upon previous products and thus extends the flexibility and expandability of the entire family.

The current list of HORIZON system building blocks is described below and is followed by an outline of how these building blocks can be combined to achieve expansion along any of the four required expansion paths.

### **HORIZON Computers with Integrated Floppy Disks**

---

#### **HRZ-2Q-64K**

- Operating systems: CP/M, DOS and ASP.
- 4 MHz Z-80A CPU.
- 64K RAM memory.
- Two Quad Floppy Disks (720Kb).
- Two serial and one parallel port.
- S-100 bus.
- S-100 Expansion slots.

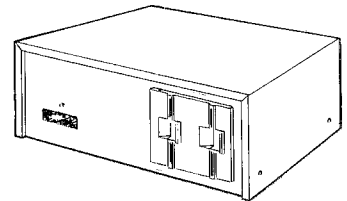

### **HORIZON Computers with Hard Disks**

---

#### **HRZ-1Q-64K-HD18**

- Same as above, except:
  - 18Mb formatted Hard Disk storage.
  - Quad capacity (360 Kb) Floppy Disk for back-up and system load.
- Operating Systems-  
HDOS  
TSS/A  
TSS/C

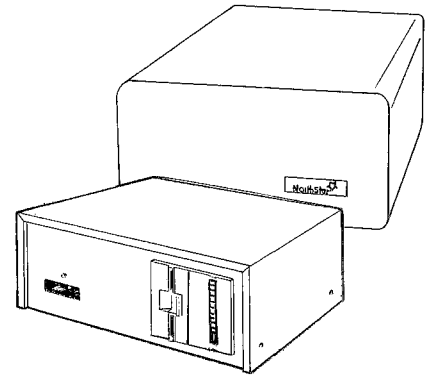

#### **HRZ-1Q-64K-HD5**

- Same as above except: integrated 5Mb Formatted Hard Disk storage.



# 3 North Star Product Overview

## North Star Software – Single User

North Star provides three single user and two multi-user operating system environments to maximize flexibility and compatibility with industry-available applications software, your own customized applications or North Star Application Software.

### **HORIZON® Single User Operating System**

CP/M® 2.2

- Widely accepted standard Z-80A® operating system.
- Compatibility with a vast array of available packaged application software.
- Supports all hardware configurations.
- Available in Floppy Disk or Hard Disk versions.
- Supports CP/M software family.

North Star DOS/  
BASIC

- Flexible and easy use.
- Included free with HORIZON® CPU.
- Available in Floppy/Hard Disk versions.
- Permits you to design and write your own applications.
- Very high performance.
- Extended decimal precision to 14 digits.
- Many valuable extensions and useful commands.
- Widely recognized, large user base and large array of user-written programs.
- Supports optional Floating Point Board (FPB) for dramatic increase in performance (1 HRZ only).

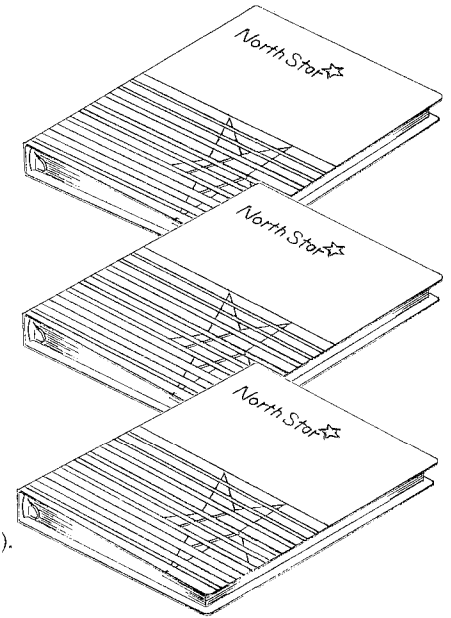

### **North Star ADVANTAGE 8/16 Single User System**

MSDOS

- Standard MicroSoft MSDOS.
- Compatible with IBM PCDOS.
- Runs 16 bit languages: BASIC 86, FORTRAN 86, COBOL 86 and Pascal 86 from Microsoft.

Graphics CP/M  
North Star ASP  
GDOS/GBASIC

- Co-processors: 16 bit 8088 and 8 bit Z80A.

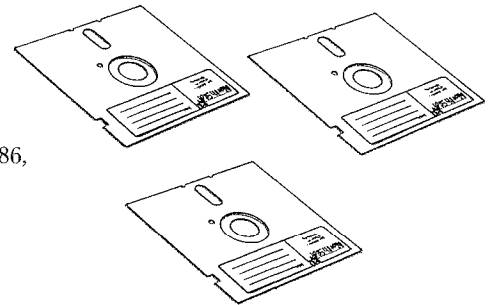

# 3 North Star Product Overview

---

## North Star Software — Multi-User

**HORIZON®**  
**Multi-User System**  
**Software**  
(Requires HD-5 or HD-18)

---

**TSS/A**  
**Operating System**

- All North Star Application Software features plus:
- Up to five users, each using the same or different applications package.
- Printer spooling.
- Supports multiple printers.
- Completely compatible with Single User ASP.
- Requires Hard Disk Version of North Star Application Software packages to be ordered separately.

**TSS/C**  
**Operating System**

- All CP/M® and DOS/BASIC features plus:
- Up to five users each using the same or different programs.
- A true CP/M superset allowing available (single user) CP/M compatible application software to run without modification.
- Supports multiple printers with true printer spooling.
- Allows each user to control multiple programs.
- File protection.
- User ID/Password Protection.
- Easy to install or upgrade from a single user system.

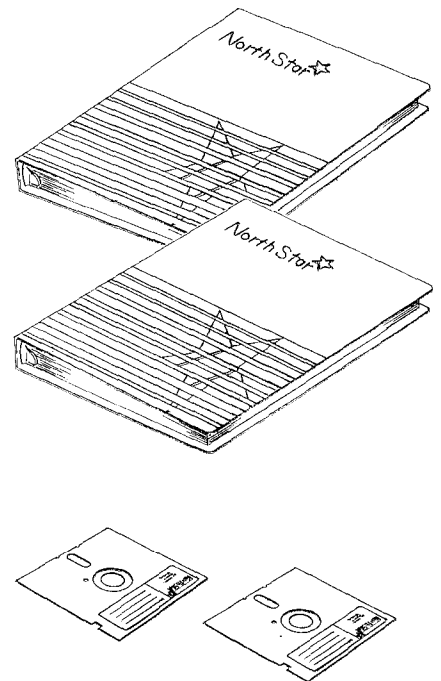

# 3 North Star Product Overview

---

## NorthNet™ Operating System

### North Star ADVANTAGE NorthNet Software

- Manages network communications plus:
- Provides network interface for GCP/M, MSDOS and ASP operating systems.
- Supports common file structure and file security.
- Controls shared network resources such as disks, printers and gateways.
- Printer spooling/despooling.

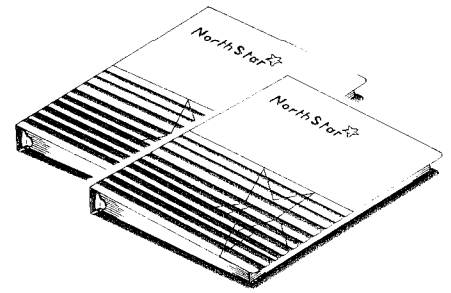

### NorthNet Manager

- Network Executive Program which controls network access plus:
- Multi-User sharing of application software.
- Configuration utility for defining changes in the network's structure or shared peripherals.
- User Maintenance Utility for defining user names, passwords, and file access authorization.
- Spooler Maintenance Utility which controls shared printers.
- Back-up/Recover Utility for maintaining shared disk resources.
- Diagnostic Utility for monitoring network traffic or testing for faulty transmission.

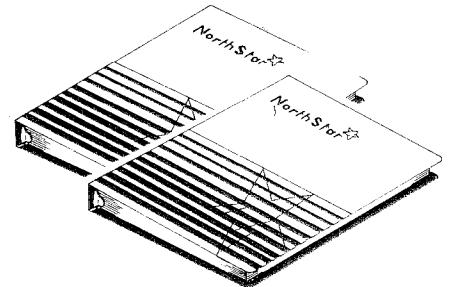
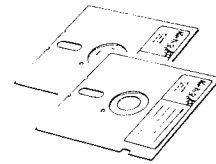

### Electronic Mail

- Easy to use message routing utilities which feature:
- Netgram — a pre-formatted, easy-to-fill-in memo of up to 1200 characters.
- Netgram or any text file transmission to one or more destinations.
- Incoming mail-waiting message when user is logged into network.
- Control over mail routing to video or printer.

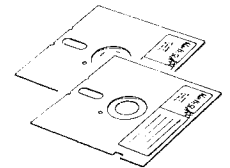

# 3 North Star Product Overview

---

## North Star Application Software

### **HORIZON® or North Star ADVANTAGE Application System Packages (ASP)**

---

NorthWord™  
InfoManager II™  
InventoryControl  
OrderEntry  
AccountsReceivable  
AccountsPayable  
GeneralLedger

- All applications integrated through shared files.
- Very easy to install.
- Can be taught easily.
- Self prompting, menu driven.
- All menus use consistent key commands.
- Fill in the blanks input screen forms with error checking.
- Provides complete Audit Trail.
- Provides customized report format.
- Supports wide variety of terminals and printers.
- Integrated operating system.
- Available in Floppy Disk or Hard Disk versions.

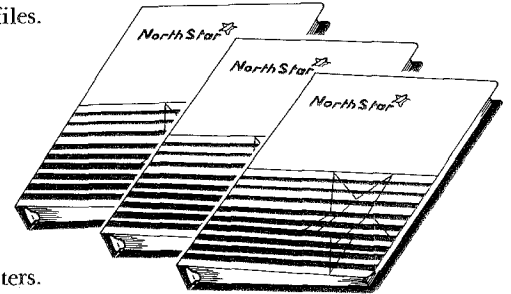

### **HORIZON or North Star ADVANTAGE PROPAC™**

---

- Designed specifically for client accounting and billing for Professionals who primarily bill by the hour (e.g. Lawyers, Doctors, CPA firms, Advertising and PR Agencies, Consultants).
- Runs on any HORIZON or North Star ADVANTAGE Hard Disk System or Floppy Disk Systems.
- Provides client profiles, activity reports, schedules, and status reports.
- Provides Client Account Receivable functions, accepts and records payments, provides A/R reports, and links to other North Star accounting applications packages.
- Supported by comprehensive user's manual and learning tutorial along with pre-designed data input forms for easy integration and installation.

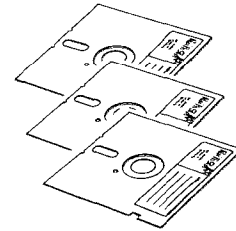

# 3 North Star Product Overview

## North Star Application Software

North Star's Integrated Application Software — Single User/Multiuser

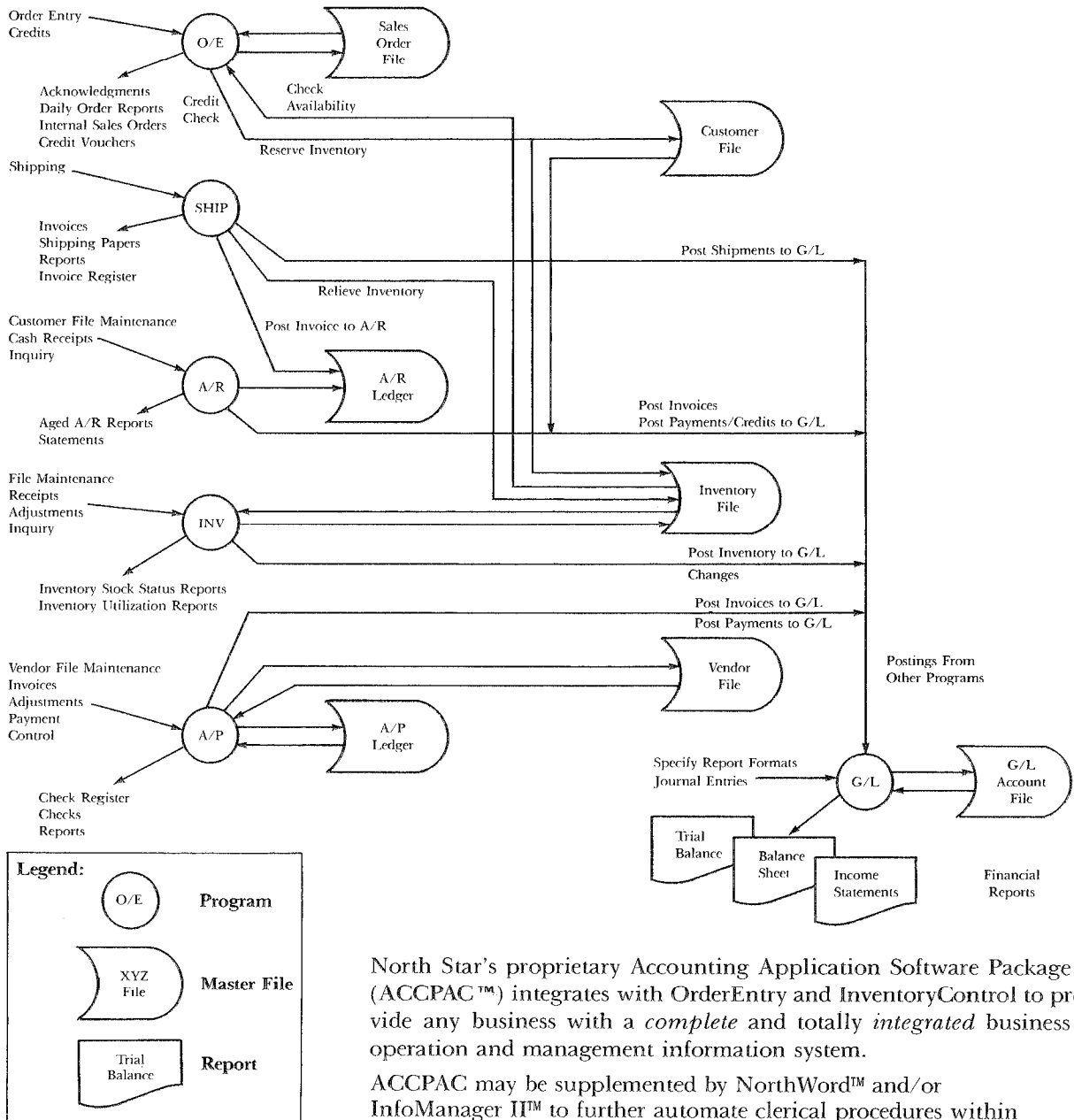

# 3 North Star Product Overview

---

## North Star CP/M<sup>®</sup> Family

### North Star CP/M Software Family

---

Enhanced  
WordStar<sup>™</sup>

SpellStar<sup>™</sup>

MailMerge<sup>™</sup>

Enhanced MicroPlan<sup>™</sup>

FORTTRAN

COBOL/M-SORT

Pascal-80

dBASE II<sup>™</sup>

- Word Processing System.
- Spelling Correction.
- Production of individualized Form Letters.
- Financial Planning and Analysis Spread Sheet.
- Microsoft<sup>™</sup>FORTRAN.
- Microsoft COBOL with M-SORT.
- Microsoft Pascal System Development Language.
- Relational Data Base Management System.

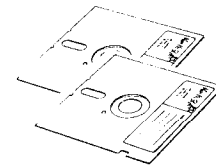
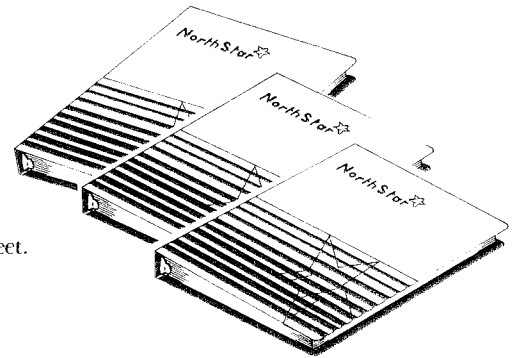

### 3 North Star Product Overview

# North Star Sample Multi-User Packaged HORIZON<sup>®</sup> Systems

#### TSS/5-A or C

**Includes:**

HRZ-1Q-64K-HD-5  
HSIO-4  
TSS/A or C

**Optional:**

Terminals  
Printers  
Tape Backup

- Simply add one terminal for single user system.
- 5Mb formatted Hard Disk Storage.
- Expandable to 5 users by adding one HRAM-64 and a terminal for each user beyond the first.
- Choice of Multi-User:  
TSS/A-North Star ASP  
TSS/C-Multi-User CP/M.  
CP/M
  - Microsoft BASIC
  - Microsoft FORTRAN
  - Microsoft COBOL
- TSS/5C requires additional HRAM-32
- Configured by Dealer.

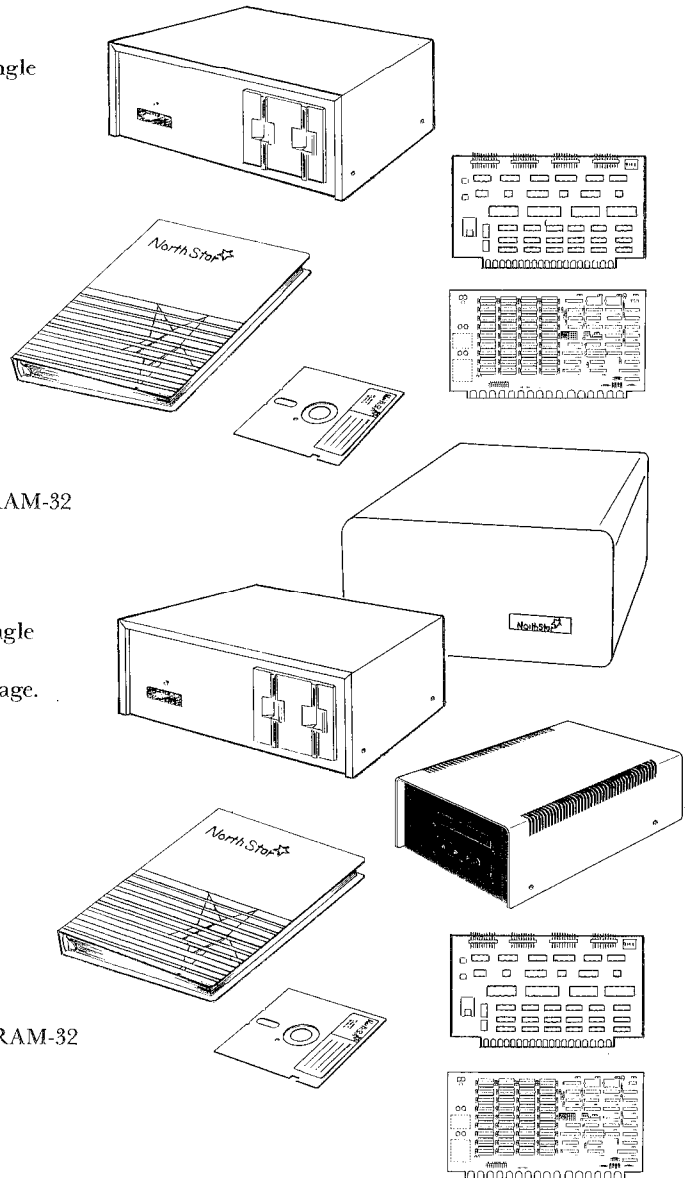

#### TSS/18-A or C

**Includes:**

HRZ-1Q-64K-HD-18  
HSIO-4  
HRAM-64's  
TSS/A or C

**Optional:**

Terminals  
Printers  
Tape Backup

- Simply add one terminal for single user system.
- 18Mb formatted Hard Disk Storage.
- Disk expandability to 72Mb total.
- Expandable to 5 users by adding one HRAM-64 and a terminal for each user beyond the first.
- 13.4Mb Tape Backup for Hard Disk.
- Same choice of TSS/A or C Multi-User Operating Systems as TSS/5 above.
- TSS/18C requires additional HRAM-32
- Configured by Dealer.

# 3 North Star Product Overview

---

## North Star System Building Blocks

North Star has just introduced an exciting new integrated graphics computer —  
The ADVANTAGE.

Single User  
North Star  
ADVANTAGE™

- Attractive integrated desk top package.
- 12" non-glare display that operates in *character* mode (80 characters by 24 lines) and *bit mapped graphics* mode (640 x 240 pixels).
- Z80A with 64Kb Dynamic RAM with parity.
- 2k prom for initial program load.
- 20K Dynamic RAM for display support.
- 87-Key Selectric style keyboard, including 15 programmable function keys, 14 key numeric/cursor control pad.
- 6 I/O bus slots for optional serial or parallel ports.  
(1) RS-232 C serial port supplied with standard system.
- Powerful Business Graphics software and end user system diagnostic package supplied with each system.
- Supported by the following North Star system and application software options:
  - Application Software Products
  - Graphics BASIC/Graphics DOS
  - Graphics CP/M
  - Business Graphics

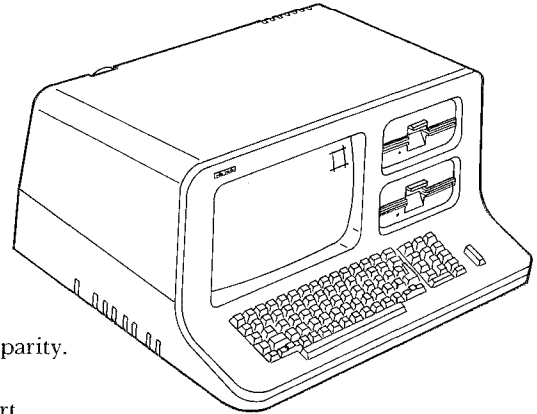



# 3 North Star Product Overview

---

## North Star System Building Blocks

### ADVANTAGE Options

---

SIO board

PIO board

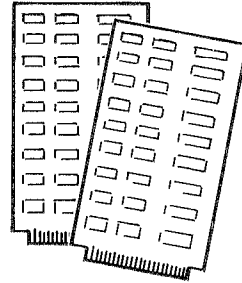

### ADVANTAGE Software

---

Graphics CP/M

Graphics BASIC/Graphics DOS

Application Software Products

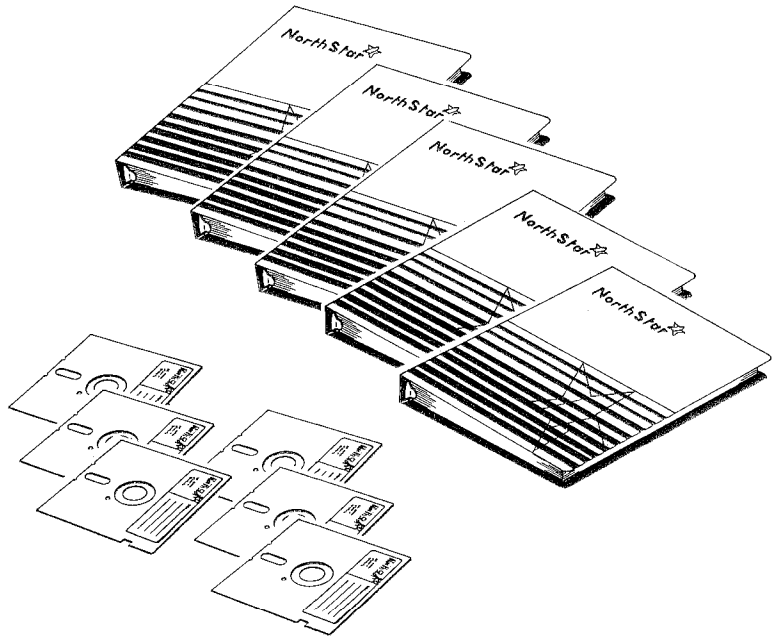

# 3 North Star Product Overview

---

## North Star Boards and Peripherals

### Add-On Hard Disks

#### HDS-5

- 5Mb formatted Hard Disk and controller.
- Installed in drive #2 slot of any HORIZON® Computer by Dealer.
- Supported by System and Application Software.

#### HDS-18

- 18Mb formatted Hard Disk and controller.
- Connects directly to any HORIZON Computer.
- Up to four drives (72Mb) can be connected to the HORIZON.
- Supported by North Star System and Application Software.

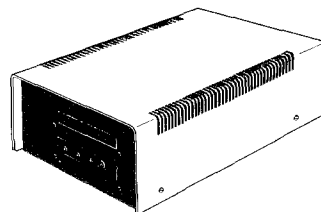

### Tape Back-up for Hard Disk

#### Tape Back-up

- 13.4 Mb capacity 1/4" tape cartridge.
- S-100 bus controller.
- Separate cabinet with integral power supply.
- Total, file by file or selective back-up and recovery utilities included.
- Compatible with all HORIZON operating systems.

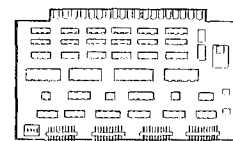
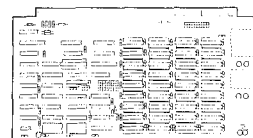

# 3 North Star Product Overview

## North Star Boards and Peripherals

### Memory Expansion Boards (S-100 BUS)

HRAM-32 (32K)  
HRAM-64 (64K)

- 200 nsec. dynamic RAM chips.
- High reliability.
- Parity checking.
- Bank select.

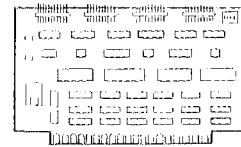
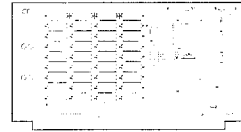

### S-100 Plug-In Boards

FPB-A

- Floating Point Board.
- Supports 14 digit precision.
- S-100 compatible.
- Supported by North Star DOS/BASIC.

HSIO-4

- Four port Serial I/O Board.
- Synchronous or asynchronous serial operation.
- RS-232C or current loop.
- Programmable synchronous baud rate selection up to 55.8K baud.
- Programmable asynchronous baud rate selection up to 19.2K baud.

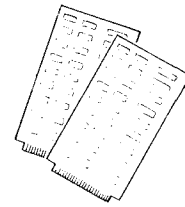

ZPB

- 4 MHz Z-80A CPU Board.
- S-100 Compatible.
- Automatic jump to preset address at power-on or reset.
- Optional 1K PROM.
- 3 level priority interrupt.

MDS Controller

- Controls up to four quad capacity 5¼" floppy disk drives.
- S-100 compatible.

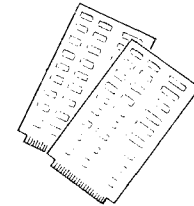

### North Star ADVANTAGE Plug-in Boards

SIO

- Serial interface—RS232C (one standard per North Star ADVANTAGE).

PIO

- Parallel interface.
- Programmable asynchronous baud rate selection up to 19.2K baud.

8/16

- 8MHz Intel 8088 co-processor board includes 64K RAM.
- Requires MSDOS operating system.

8/16 64K RAM Add-on

- 64K RAM module permits expansion of 8/16 memory to 128K, 196K or 256K RAM.

# 3 North Star Product Overview

---

## North Star System Printers

NS-100  
Dot  
Matrix  
Printer

- 80 cps., 132 column.
- 8-bit parallel (Centronics) interface or RS-232C Serial interface.
- Tractor or friction feed.
- Prints paper up to 15.5" wide.
- Single/double dot density characters for "almost letter quality".
- Parallel interface included.
- Excellent for graphics printing of North Star ADVANTAGE screen.

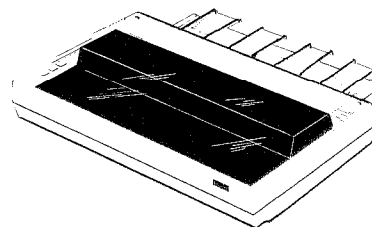

NS-3510  
Letter  
Quality  
Printer

- 33 cps.
- 128 characters/element.
- Wide variety of domestic and foreign character sets.
- Self test features.
- Automatic bidirectional print.
- Bidirectional tractor.
- Sound shield.
- Impeccable print quality.

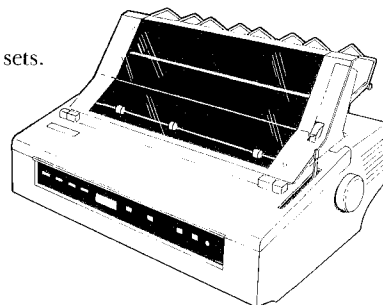

# 3 North Star Product Overview

---

## Suggested Retail Price List\*

August 1, 1982

### Computer Systems

---

#### Single User<sup>1</sup>

North Star ADVANTAGE	<ul style="list-style-type: none"><li>• Two Floppies (360Kb each)</li><li>• 5Mb Hard Disk + 360Kb Floppy</li></ul>	\$3,599 4,999
HORIZON®	<ul style="list-style-type: none"><li>• Two Floppies (360Kb each)</li><li>• 5Mb Hard Disk + 360Kb Floppy</li><li>• 18Mb Hard Disk + 360Kb Floppy</li></ul>	\$3,599 4,999 7,999
North Star ADVANTAGE 8/16	<ul style="list-style-type: none"><li>• Two Floppies (360Kb each)</li><li>• 5Mb Hard Disk +360Kb Floppy</li></ul>	\$4,099 5,499

#### Typical Multi-User HORIZON Configurations<sup>2</sup>

	5Mb Hard Disk + 360Kb Floppy	18Mb Hard Disk + 360Kb Floppy
2 users:	\$6,049	\$ 9,049
3 users:	6,749	9,749
4 users:	8,449	10,449
5 users:	8,149	11,149

<sup>1</sup>Single-User North Star ADVANTAGE and HORIZON configurations include 64K user memory. North Star ADVANTAGE prices include a diskette containing Business Graphics, demonstration and diagnostic software. HORIZON prices include a diskette containing DOS/BASIC or HDOS/BASIC, and diagnostics software. All HORIZON computers come in a standard metal cover. Wood covers are an extra cost option and are shipped separately.

<sup>2</sup>Multi-User HORIZON hardware prices include the necessary one 64K RAM per user and one Four Port Serial I/O board per system. Operating system, printer and terminals are extra.

\*Prices subject to change without notice.

---

### 3 North Star Product Overview

---

## Suggested Retail Price List (continued)

### Software

---

#### North Star Application Software Family

---

NorthWord™	\$ 199
InfoManager II™	399
GeneralLedger	499
AccountsReceivable	499
AccountsPayable	499
InventoryControl	499
OrderEntry & Invoicing	499
Professional Client Accounting & Billing (PROPAC™)	1,499

#### Operating Systems: Single-User

---

North Star ADVANTAGE	Graphics CP/M	\$149
	Graphics DOS/BASIC	149
	North Star Applications (Hard Disk)	149
North Star ADVANTAGE 8/16	MSDOS™	\$149
HORIZON®	CP/M® 2.2	\$149
	DOS/BASIC	Included with HORIZON.

#### Operating Systems: Multi-User

---

HORIZON	TSS/A (North Star Applications)	\$349
	TSS/C (CP/M Applications)	349
	TSS/C (with 32K RAM)	549

---

# 3 North Star Product Overview

---

## **Suggested Retail Price List** (continued)

**CP/M®  
Software  
Family**

---

Enhanced WordStar™	\$500
SpellStar™	250
MailMerge™	150
Enhanced MicroPlan™	399
FORTTRAN	499
Pascal-80	600
COBOL/M-SORT	875
dBASE II	700

# 3 North Star Product Overview

---

## Suggested Retail Price List (continued)

### Boards and Subsystems

---

#### North Star ADVANTAGE

---

Parallel Interface Board	\$200
Serial Interface Board	175
Work Station Board—NorthNet	399
Server Board—NorthNet	499
North Star ADVANTAGE 8/16 Upgrade	499
8/16 64K RAM Add on	349

#### HORIZON®

---

18Mb Hard Disk System Add-On	\$5,374
5Mb Hard Disk System Upgrade	2,399
Tape Backup System	3,895
64K RAM Memory Board	699
32K RAM Memory Board	499
Four Port Serial I/O Board	349
Z-80A® Processor Board	325
Floating Point Board	399
Floppy Disk Controller Board	565

#### NorthNet™

---

Work Station Pack	\$399
Server Pack	499
Cable Pack	249
Tap Pack	69
NorthNet™ O.S.	349
Repeater	99

### Printers

---

NS 3510	Letter Quality Printer with Serial Interface	\$2,589
NS 100	Matrix Graphics Printer with Parallel Interface	995
	Serial Interface (Optional)	155

Consult your Authorized North Star Dealer for products not listed. Prices and specifications are subject to change without notice. Cables and supplies are extra.

---



# 3 North Star Product Overview

---

## Multi-User System Price/Per User

North Star's Application Software or industry available application software running under TSS/A or C provides an extremely competitive and cost effective system for a wide range of end users.

The following tables are presented as guidelines to assist dealers in configuring a North Star system and determining competitive position against other multi-user systems. Table 3.1 illustrates price per user as a function of the number of users for various North Star multi-user configurations. Table 3.2 contains our estimates of the capacity of our Application modules versus disk storage capacity.

The price per user table (Table 3.1) assumes each system contains the CPU, appropriate CRTs disks, controllers, memory and operating system. No application software modules or printers are included in the prices shown.

**Table 3.1**  
**Price<sup>1</sup> Per User (including CRT)<sup>2</sup>**  
**vs.**  
**Number of Users**

	2 users	3 users	4 users	5 users
TSS/A-5Mb	\$3698	\$2865	\$2449	\$2199
TSS/C-5Mb	3798	2932	2499	2239
TSS/A-18Mb	\$5223	\$3882	\$3211	\$2809
TSS/C-18Mb	5323	3948	3261	2849

<sup>1</sup> All prices are subject to change without notice.

<sup>2</sup> Assumes \$500 for end-user CRT price.

# 3 North Star Product Overview

---

## Multi-User System Price/Per User

The capacity analysis table<sup>2</sup>(Table 3.2) is divided into two sections: single user floppy disk (Table 3.2A) and multi-user Hard Disk (Table 3.2B). The floppy disk table reflects the maximum capacity of each application based on the capacity of the diskette(s) used for storage by that application. Thus the capacities shown in Table 3.1A are additive (i.e. a system may contain all of these capacities together.)

For HD-5/HD-18 systems all files for all applications must fit on a single Hard Disk (non removable) and thus there are *two ways* to analyze capacities:

1. What is the capacity if the disk were *dedicated* to a given application?
2. What is the capacity of each application if all applications are combined on one Hard Disk in a reasonable way?

Table 3.2B reflects both of these methods of capacity analysis. First the capacities are shown for each Application module as though it were the only module occupying the disk. Then capacities are shown based on the following storage allocation assumption for a combination of all applications:

1. For HD-5, 2Mb is reserved for program storage, NorthWord, etc.
2. For HD-18, 4Mb is reserved for program storage, NorthWord, etc.
3. GeneralLedger is assumed to be 250 Accounts.
4. A/R and A/P are assumed equal and InventoryControl occupies all remaining storage capacity.

Both tables 3.2A and 3.2B reflect the following additional assumptions:

5. NorthWord is limited to 250 pages per project. There is no limit to the number of projects on a Hard Disk system within disk capacity. For the purposes of this analysis, a single 250 page project is assumed.
6. Info/MailManager records are assumed to be 160 characters with one 30 character and one 6 character key.
7. InventoryControl records are assumed to contain only the basic record segment plus quantities, costs and basic sales history options.

---

<sup>2</sup>The capacities shown in Table 3.2 are estimates only and should not be construed to represent a warranty.

# 3 North Star Product Overview

---

## System Capacity Per User

**Table 3.2A**  
Single User Systems Capacity

System	STORAGE CAPACITY Mb	RETAIL PRICE \$	NORTHWORD (PAGES)	INFO MANAGER (ITEMS)	G.L. ACCOUNTS	A/R (CUSTOMERS)	A/P (VENDORS)	INVENTORY (ITEMS)
HRZ-2Q-64K	.72	3599	128	1222	300	400	385	1300
ADV-1Q-64K-HD5	5	4099	250	3,330	5,000	10,000	4,500	10,000

**Table 3.2B**  
Multi-User Hard Disk Systems Capacity

System	STORAGE CAPACITY Mb	NORTHWORD (PAGES)	INFO MANAGER (ITEMS)	G.L. (ACCOUNTS)	A/R (CUSTOMERS)	A/P (VENDORS)	INVENTORY (ITEMS)
HRZ-1Q-64K-HD5	5	250	3,300	5,000	10,000	4,500	10,000
HRZ-1Q-64K-HD18	18	250	40,000	5,000	10,000	10,000	56,000
HRZ-1Q-64K-HD18 (X2)	36	250	80,000	5,000	10,000	10,000	56,000

Maximum capacity of each module by itself

# NorthStar<sup>TM</sup> NorthWord<sup>TM</sup>

Introducing NorthWord, the word processing program from North Star Computers... easy to learn, easy to use, and it gets the job done effectively and efficiently.

NorthWord was specifically designed as a word processing program for the North Star Horizon<sup>®</sup> Computer. It incorporates the most sought after features available, making NorthWord a first choice for attorneys, doctors, accountants, educators and businessmen.

## **NORTHWORD WORKS TO INCREASE YOUR OFFICE PRODUCTIVITY**

NorthWord provides a wide variety of services to assist in office automation. Documents can be stored in the computer and retrieved in part or whole for utilization in new texts. Additions and deletions can be completed at the touch of a button. Your documents can be formatted to specific criteria regulating page numbering, titles, underlining, margins, spacing, etc. And NorthWord presents a menu of activities on a video screen to make selection of activities a simple procedure. Finally, NorthWord is screen-oriented—margins, indents and justification appear on the screen precisely as they are to be printed. Practicality and simplicity are the keynotes to the success of the NorthWord program.

## **AN EASY-TO-USE PROGRAM FOR INEXPERIENCED USERS**

NorthWord was designed with first-time users in mind. For example, the program is accompanied by a sample diskette which assists the operator (through practice exercises) with the program functions. A "hands-on" approach to instruction in the NorthWord User's Manual facilitates fast and easy learning, bringing people and small computers together. To help the uninitiated (and even the experienced user), NorthWord is accompanied by a unique label that attaches above your keyboard. By defining important keys, this label eliminates the need to memorize numerous "edit codes" and "control keys."

## **DOCUMENTATION**

Simplicity is key to the instructional process and this is evidenced by the first-rate instruction and reference manual. The instruction manual is thorough and easily understood, carrying you step-by-step through the various program functions.

## **INTEGRATE NORTHWORD WITH OTHER PROGRAMS FOR INCREASED SYSTEM VERSATILITY**

NorthWord is part of the family of North Star Application Software programs which function either independently and in conjunction with other programs in the family. For example, the NorthWord word processing program can be coupled with North Star's MailManager<sup>™</sup> mailing list program enabling mass production of correspondence, labels and reports with utmost efficiency. Other programs offered in the North Star Application Software line include GeneralLedger<sup>™</sup>, AccountsReceivable<sup>™</sup>, and AccountsPayable<sup>™</sup>, all of which function separately or as a total accounting package. The integrated nature of North Star Application Software simplifies the business of adding new programs and/or the transition from one program to another. Consistent format and method of operation is maintained throughout all the programs for ease of use. As a result, training time and cost—problem areas with many computer systems—are kept to a minimum.

## **PROVEN SUCCESS**

NorthWord is in use in accounting and legal offices, in businesses and schools. Its success is the result of a simple, straightforward approach to using computers. Thoroughness and expertise of design are a guarantee of high quality, and competitive pricing assures cost efficient operation.

## **PRINCIPAL PROGRAM FEATURES:**

### **TYPE DOCUMENTS WITH EASE**

- Store up to 20 different documents on each diskette
- Identify each document with any name or number
- Have unlimited document storage on inexpensive diskettes
- Duplicate or format diskettes rapidly
- Select from menus on screen—no need to learn complex command codes
- Handle common operator mistakes with easy-to-understand instructions from the screen
- Alphabetized document index is continuously updated and displayed
- 80 character by 24 line video display
- Horizontal scrolling lets you compose and view lines up to 160 characters wide, ideal for financial reports
- Automatic margin readjustment by paragraph
- Unlimited adjustable tab stops
- Automatic carriage return, word wraparound, and justification with manual hyphenation
- Easy merging of frequently used phrases, paragraphs and mailing lists
- All documents may include comments which appear on the screen but not on the printout

### **CHANGES AND CORRECTIONS ARE EASY WITH THESE EDITING FEATURES**

- Easy insertion, deletion or alteration of text
- Easy-to-use command keys
- Instant positioning of cursor to start or end of document
- Automatic scrolling—horizontal or vertical, forward or reverse
- Single step or continuous cursor movement in four directions, home cursor, and jump to screen edges
- Jump forward or backwards by screenful of text
- Automatic search and selective replacement of words, phrases, format statements or comments (Global Search and Replace)
- Copy, move or delete in blocks of up to 20 lines
- Merge standard paragraphs into any document
- Merge and assembly text can be organized in special library documents

### **DESIGN TEXT FORMAT RIGHT ON THE SCREEN**

- Margins, indents and justification appear on the screen exactly as they will be printed
- Embedded format control statements are displayed on the screen
- Store many standard text formats to maintain document consistency
- Optional headers and footers on each page—multiple lines and location versatility
- Automatic centering of text at time of printing
- Automatic pagination divides long documents into separate pages with forced page breaks and widow elimination

- Automatic page numbering beginning with any number anywhere in the document.

#### **PRINT DOCUMENTS WITH FLEXIBILITY**

- Print one document while editing another on the screen
- Bidirectional printing
- Adjustable character and line spacing
- Boldface through multiple overstrike
- Underscore capability
- Copy can be up to 160 characters wide
- Quick printer selection for multiple-printer installations
- Printing options for skipping pages, page stops, and printing embedded statements or comments
- Option for automatic centering at print time

#### **A SUMMARY OF DOCUMENT ACTIVITIES AND PROGRAM FUNCTIONS:**

##### **DOCUMENT ACTIVITIES**

Create (start new document)  
Remove (erase a document)  
Edit  
Select Merge (select a merge document)  
Print  
Stop Printing  
Eject Page (form feed)  
Archive (copy document to System Disk)  
Retrieve (copy archive document to Data Disk)  
Screen Print (print document on screen)

##### **EDIT KEY FUNCTIONS**

Cursor Control (up, down, right, left, or home)  
Cursor to Edge of Screen (four directions)  
Repeat (character or cursor)  
Return (forced end of paragraph)  
Left/Right Margin Set/Release  
Tab Set/Clear  
Jump to Start/End (of document)

Justify On/Off  
Search  
Continue Search  
Replace  
Continue Replace  
Copy Block  
Move Block  
Insert Block  
Delete Line  
Insert Split  
Center  
Close Paragraph  
Call Merge  
Reserve Blanks (through justification process)  
Escape (go from editing to Document Activity Menu)

##### **FORMAT STATEMENTS ("dot commands")**

Pitch (horizontal space per character)  
Vertical (spacing per line)  
Spacing (double, triple, other multiples)  
Define Form Length  
Lines Per Page  
Title (running header)  
Footer (running footer)  
Header Lines (header + margin)  
Bottom Lines (footer + margin)  
Number (set or reset page number)  
Eject (force new page)  
Widow (keep lines together on page)  
Under (underline, boldface, overstrike)  
Center (at time of printing)  
Offset (on page when printing)

---



**NorthStar**<sup>TM</sup>  
North Star Computers, Inc.  
14440 Catalina St, San Leandro, CA 94577 USA  
(415) 357-8500 TWX/Telex (910) 366-7001

Horizon and NorthWord are registered trademarks or trademark of North Star Computers, Inc.

MailManager, InfoManager, ACCPAC, GeneralLedger, AccountsReceivable and AccountsPayable are trademarks of Basic Software Group.

# NorthStar<sup>TM</sup> InfoManager<sup>TM</sup>

A powerful data inquiry system has many applications in today's business environment. It can help provide doctors and dentists with complete and current patient records, publishers and service organizations with detailed subscription lists and subscriber data, businessmen and professionals with calendar management functions, and businesses with customer records. North Star Computers has created InfoManager, a data management program for the Horizon<sup>®</sup> computer. InfoManager can provide small businesses with complete and instantly accessible records information.

## **POWERFUL, EASY-TO-USE DATA MANAGEMENT**

InfoManager is a powerful data management system that, unlike a simple mailing list system, has a greatly increased capacity to store and manipulate your information. InfoManager will accept up to 50 fields of information for each record in a list; it has a numeric capability (making entry of dollar information much easier); and it has the ability to select and sort before printing. This latter function enables InfoManager to perform reporting tasks, providing a valuable management resource. The ability to extract and sort information — in any order and by multiple levels — and then print out reports and letters create a management planning capability that can greatly enhance forecasting ability in areas of sales, budgets, inventory requirements, capital requirements and so forth.

## **INFOMANAGER INCREASES OFFICE PRODUCTIVITY**

Wholesalers and retailers can use the InfoManager system as a powerful product inquiry system — including storing details or obtaining instant product information. Customers will be impressed by the speed and accuracy with which you will be able to answer their inquiries; there's no need to fumble through bulky catalogues or card files.

Maintenance of accurate customer or client records is a must for many businesses (doctor's, dentist's, accountant's and lawyer's offices, retail stores, and automotive shops, to name only a few). With InfoManager, you can retain up to 50 fields of information about each customer which can be instantly accessed via the computer's video screen. Your office can select and sort customer records by criteria, and print reminder letters, announcements of new products, mailing labels for advertising literature, etc.

With InfoManager, you can also enter information that can be used as an instant calendar reminder. At any time, you can obtain a printout of those matters to be attended to during a given period of time. If there are several individuals using such a calendar management system, you can even sort and list the matters by individual.

Companies in the construction industry find InfoManager an invaluable tool for maintaining an inventory of tools and equipment at different job sites. At any time the equipment manager can find out where a tool is, or what tools are being used on a given job. Where regular maintenance is required, InfoManager can be instructed to print a list of equipment requiring maintenance on a given day — you can even break down one piece of equipment into its many components requiring separate maintenance.

And, best of all, InfoManager can be used for several totally different data inquiry systems at the same time. Uses for InfoManager are limited only by your imagination.

## **DOCUMENTATION**

InfoManager comes with a complete User's Manual that explains all facets of the program in easy-to-understand terminology. The User's Manual includes numerous "hands-on" examples to help you learn the program's capabilities; it even provides guidance on how to use the program in several specific situations.

## **INCREASE INFOMANAGER APPLICATIONS WITH ADDITIONAL PROGRAMS**

InfoManager is part of a family of North Star Application Software programs which either function independently or in conjunction with other programs in the family. For example, use NorthWord<sup>™</sup> word processing system to create letters or fill-in-blanks forms that can be used with InfoManager. Other programs offered in the North Star Application Software line include GeneralLedger<sup>™</sup>, AccountsReceivable<sup>™</sup> and AccountsPayable<sup>™</sup>.

## **PRINCIPAL PROGRAM FEATURES:**

### **FLEXIBILITY IS THE KEYWORD FOR INFOMANAGER**

- Store a data information list on up to 3 floppy disks if you have a 4-drive system
- Create several information files with different characteristics for different purposes
- Define the data items to be included in each record when you generate your information file (you can generate many different information files)
- Specify up to 50 individual data items per record in the list
- Define a data item to be alphanumeric or strict numeric at the time of specifying the parameters of your list
- Specify the size of the data fields (each can be up to 30 positions long)

### **ENTER, STORE, MANIPULATE, AND PRINT YOUR INFORMATION WITH EASE**

- InfoManager provides a powerful "Double Key" system for record retrieval purposes — you can define any two of the data fields in a record to be the keys
- Using either of the two keys, you can locate any record in your file of information within seconds regardless of the number of records in the file, and display the data on the computer's video screen in easily-readable format
- Use the video screen to add, modify, or delete information in any record rapidly
- Delete a range of entries, or group of entries that share specific characteristics
- Obtain hard-copy echo of changes made to the information list
- Print a List Information Report at any time which provides an up-to-date status of the maximum number of records you can have in your list, the number of records presently in the list, and the space available for additional records.

### **PRINT REPORTS, LETTERS AND LABELS WITH INFOMANAGER**

- Print reports, letters and labels using the information in your information list

- Print a selected group of records or a statistical sample drawn from the list
- Print record or customer reports in sequence or individually by page
- Use InfoManager to print one or several mailing labels across a page or on label forms
- If you want to use InfoManager as a mailing list program, you have complete flexibility in defining mailing label formats (number side by side, size, and data to be printed)
- Print reports, labels and letters at high speed with a wide variety of printers

#### **MERGE INFORMATION FROM YOUR DATA FILE INTO PERSONALIZED LETTERS**

- Use the NorthWord word processing system to create an unlimited number of custom letters or forms for use with InfoManager — this feature is great for sending letters to customers or clients about whom you are keeping information
- Put easy-to-use codes in letters created with NorthWord that instruct InfoManager what information from your information list you want inserted in a letter or form, and where you want it to appear
- Information is inserted into custom letters in such a way that the letters appear to be one-of-a-kind (your clients or customers will be impressed with the personal-looking service)
- Print personalized letters for all records in your data file, or for a select group or a sample without having to reinitiate the processing of each letter (you can even attach your own letterhead to continuous forms paper for high speed printing)
- Print on single sheet paper or continuous forms
- Print tables by creating special forms with NorthWord into

which InfoManager can insert selected information from your information file

- Quick printer selection for multiple printer installations

#### **SORT INFORMATION IN YOUR DATA FILE AT HIGH SPEED**

- Prior to printing information, you can tell InfoManager to sort it into any order you want at high speed
- Specify up to five fields in a record for sorting purposes (five-level sort)
- Sort records into ascending or descending sequence
- Specify criteria for records to be selected for inclusion in the sorting process (equal to certain values, within specified ranges, etc.) — in this way you can quickly extract, and sort into meaningful order those records that have the attributes specified
- Instruct InfoManager to do several printing runs after information has been extracted and sorted

#### **LIST CAPACITIES**

InfoManager's list capacities vary with the storage capacity of the diskette, the size of the Unique (primary) and Duplicate (secondary) Keys, and the size of the list record defined. The List Capacity Table shown on the MailManager data sheet is also applicable for an InfoManager list with a Unique Key length of 30 characters and a Duplicate Key length of 6 characters.



**North Star Computers, Inc.**

14440 Catalina St, San Leandro, CA 94577 USA  
(415) 357-8500 TWX/Telex (910) 366-7001

Horizon and NorthWord are registered trademarks or trademark of North Star Computers, Inc.

MailManager, InfoManager, ACCPAC, GeneralLedger, AccountsReceivable and AccountsPayable are trademarks of Basic Software Group.

# NorthStar™ MailManager™

An organized and current mailing list that includes dealers, outlets, clients, patients, subscribers, suppliers, members, donors, applicants, etc. can be of tremendous value to businessmen, salesmen, professionals and service organizations. Now you can obtain the many timesaving capabilities of an automated mailing list system with the help of MailManager, the mailing list program from North Star Computers.

## **DESIGNED TO ACCURATELY MAINTAIN YOUR MAILING LISTS**

MailManager is a mailing list program designed specifically for the North Star Horizon® computer. It provides an affordable, efficient and totally confidential means to compile and maintain mailing lists for use by small businesses.

MailManager is designed to allow your business to quickly and efficiently create and revise mailing lists. Simple insertion of names, addresses and/or other pertinent information into your computer results in an organized, easily-accessible list. And, lists can be compiled with a great deal of flexibility in the data structure—up to 10 data items can be entered for each record in the list (with alphabetical items being up to 30 characters in length). No matter what additions or deletions are made, MailManager will always maintain its file order.

## **MAILMANAGER INFORMATION CAN BE USED IN A VARIETY OF WAYS**

Once the information has been fed into your computer it can be accessed in alphabetical order or zip code order. Use the computer's video screen to review the status of a customer on the mailing list instantly; or print reports, mailing labels, and letters for the complete mailing list, or for customers selected by criteria that you specify.

Lists can be sub-divided into sub-lists to facilitate communications to specific groups. For example, zip codes can be selected according to dates, titles, postal codes, etc. to enable you to use MailManager for appointment or subscription reminders, or for selective mailouts to specified contacts. The program will also sort mass mailing pieces to make use of bulk mail rates. MailManager has another important, implicit feature: in-house mailing lists are absolutely confidential.

## **MAILMANAGER AND NORTHWORD™— THE PAPER MOVERS**

MailManager is part of the family of North Star Application Software programs which will function either independently or in conjunction with other programs in the family. Specifically, the MailManager functions as the perfect companion to the NorthWord word processing program. It completes the package we call "The Paper Movers." This combination uses NorthWord to produce a variety of standard letter formats, then MailManager merges with them to produce the personalized touch of individually addressed headings, addresses, salutations, and other information from your mailing list.

## **YOU'LL FIND IT EASY TO USE**

MailManager, as does all North Star Application Software, stresses simplicity of instruction, ease of use and thoroughness of associated documentation. MailManager comes with a complete and extensive instructional manual emphasizing a step-by-step, hands-on approach to the learning process.

## **PRINCIPAL PROGRAM FEATURES:**

### **FLEXIBLE OPTIONS FOR DEFINING YOUR MAILING LIST**

- Store a mailing list on up to 3 floppy disks if you have a 4-drive system
- Create several mailing lists with different characteristics for different purposes
- MailManager lets you define variable data items to be included in each record when you generate your mailing list (you can generate several different mailing lists)
- Specify up to 10 individual data items per list record
- Enter alphabetic or numeric data in data fields
- You can specify the size of the variable data fields (up to 30 characters long)

### **MANAGE LIST RECORDS WITH EASE**

- MailManager provides a powerful "Double Key" system for record retrieval purposes
- Locate a customer record by either Name or Zip Code within seconds regardless of the size of your mailing list
- Add, modify, or delete information in a mailing list record rapidly
- Delete a range of entries, or group of entries that share specific characteristics
- Obtain a hard-copy echo of changes made to the mailing list records
- Print a List Information Report at any time which provides an up-to-date status of the maximum number of records you can have in your list, the number of records presently in the list, and the space available for additional records

### **PRINT REPORTS, LABELS, AND LETTERS WITH MAILMANAGER**

- Print reports, labels, or letters using the information in your mailing list
- Print a selected group of records or a statistical sample drawn from the list
- Print reports about a record or customer on your mailing list in sequence or individually by page
- Print one or several mailing labels across a page or on label forms
- MailManager provides complete flexibility for defining mailing label formats (number side by side, size, and data to be printed)
- Print reports, labels and letters at high speed with a wide variety of printers
- Print labels or envelopes in Zip Code order automatically to take advantage of bulk postage rates

### **MERGE MAILING LIST INFORMATION INTO PERSONALIZED LETTERS**

- Use the NorthWord word processing system to create an unlimited number of custom mailing letters for use with MailManager
- Put easy-to-use codes in letters created with NorthWord that tell MailManager what information from your mailing list you want inserted in the letter, and where you want it to appear
- Mailing list information is inserted into custom letters in such a way that the letters appear to be one-of-a-kind (your clients or customers will be impressed with the personal-looking service)



- Print personalized letters to everyone on the mailing list, to a select group or to a sample without having to reinitiate the processing of each letter (you can even have your own letterhead on continuous forms paper for high speed printing)
- Print on single sheet paper or continuous forms
- Print tables by creating special forms with NorthWord into which MailManager can insert selected information from your mailing list
- Quick printer selection for multiple printer installations

#### LIST CAPACITIES

The following tables indicate how many records of a given length will fit into a list created on one, two, or three data disks with either dual or quad capacity. The number in the applicable column below NUMBER OF RECORDS is the number of individual list records that can be stored for the RECORD LENGTH shown.

**LIST CAPACITY TABLE FOR THE NORTH STAR HORIZON**  
Double Density Disk Drives

Record Length	Number of Records		
	1 Data Disk	2 Data Disks	3 Data Disks
70	805	1396	1396
80	805	1396	1396
90	756	1396	1396
100	726	1396	1396
110	661	1396	1396
120	661	1288	1396
130	622	1188	1396
140	598	1104	1396
150	592	1030	1396
160	556	996	1396
170	522	908	1396
180	514	858	1396
190	510	812	1396
200	486	772	1396
210	462	736	1396
220	442	702	1396
230	441	672	1384
240	438	644	1326
250	420	618	1272
260	404	594	1224
270	390	572	1178
280	376	552	1136

**LIST CAPACITY TABLE FOR THE NORTH STAR HORIZON**  
Quad Capacity Disk Drives

Record Length	Number of Records		
	1 Data Disk	2 Data Disks	3 Data Disks
70	1856	3010	3010
80	1726	3010	3010
90	1626	3010	3010
100	1554	3010	3010
110	1480	3010	3010
120	1424	2790	3010
130	1378	2574	3010
140	1326	2390	3010
150	1248	2232	3010
160	1222	2092	3010
170	1190	1968	3010
180	1132	1860	3010
190	1092	1762	3010
200	1058	1674	3010
210	1043	1594	3010
220	1000	1520	3010
230	956	1454	3010
240	948	1394	2828
250	912	1338	2714
260	899	1286	2610
270	876	1240	2514
280	844	1194	2424



**North Star Computers, Inc.**

14440 Catalina St, San Leandro, CA 94577 USA  
(415) 357-8500 TWX/Telex (910) 366-7001

Horizon and NorthWord are registered trademarks or trademark of North Star Computers, Inc.

MailManager, InfoManager, ACCPAC, GeneralLedger, AccountsReceivable and AccountsPayable are trademarks of Basic Software Group.



## **THE ACCPAC ACCOUNTING SYSTEM DELIVERS FAST, COST-EFFICIENT INFORMATION**

We at North Star have developed three complete automated accounting programs for our Horizon® computer: GeneralLedger™, AccountsPayable™ and AccountsReceivable™. When combined, these three programs comprise ACCPAC, a complete computerized accounting system for your business. With ACCPAC your accounting records are always up to date, and your financial statements and reports are tailored to your particular information needs. The more accurate, complete and accessible your accounting system is, the more timely and accurate your business decisions can be.

## **THREE ACCOUNTING PROGRAMS IN ONE EASY-TO-USE SYSTEM!**

You can start with a complete ACCPAC system or with just the one program you need most, because ACCPAC includes three self-contained programs, GeneralLedger, AccountsReceivable and AccountsPayable, that operate independently or as a fully integrated accounting system.

ACCPAC was designed by professional accountants to provide you with sound accounting controls and maximum reliability. ACCPAC's easy-to-understand programs require no knowledge of accounting or computers on your operator's part. The operator works at a typewriter-style keyboard, responding to the computer's questions and messages as they appear on the video screen.

The ACCPAC programs have many built-in safeguards against errors and loss of data. They recognize many types of errors at input time and respond by placing an error message on the screen. Furthermore, the programs check that transactions balance and that account numbers are correct before proceeding, printing easy-to-understand edit reports to let corrections be made. And, when it's advisable to make back-up copies of data to protect against loss, the program will warn the operator to do so before proceeding.

All ACCPAC programs share similar characteristics. All use similar "menus," interactive format, and messages warning against errors and data loss. You can start with one program and add the others later, or you can begin with the whole system.

## **WORD PROCESSING AND DATA MANAGEMENT SYSTEMS**

In addition to ACCPAC, we can provide NorthWord™ (our word processing system), MailManager™ (a complete mailing list system) and InfoManager™, a powerful data management system.

## **OPERATIONAL ACCPAC FEATURES**

- Each ACCPAC program comes with a detailed User's Manual which addresses both the accountant (explaining the program's accounting capabilities) and the operator (carefully describing how to operate the program, extensively utilizing "hands-on" exercises).
- All programs feature "menus." Their uniform operational style makes transfer from program to program simple.
- The programs can be used with a number of terminals and printers. The selection of each is done via the "menu."
- Copying disks is easy with the quick, "menu"-selected diskette backup routine.
- The program prompts the operator when either data is required or an error has been made.

- Easy, fill-in-the-blank video forms are used for data entry.
- The operation is program controlled throughout, including easy-to-understand error messages.

## **GeneralLedger**

To manage your business well, you need both up-to-the-minute information on daily transactions and reports, and financial statements that summarize that data in ways meaningful for decision making. ACCPAC's GeneralLedger and Financial Reporting System gives you both, quickly and accurately.

You can enter detailed transactions from almost any source—automatically transferring receivables and payables information from ACCPAC's other programs. Once transactions have been entered, the program controls the correction of errors and posting to the general ledger. At the touch of a button you can obtain such reports as batch edit listings, transaction source journals or a detailed general ledger.

The ultimate benefit of a computer-maintained general ledger management system is in the area of financial reporting. Our uniquely flexible system can be tailored to your specifications, thereby enabling you to display data in any form you choose. Now you can have information at your fingertips regarding sub-totals and totals, inclusion of written text, column format, or selection of general ledger accounts accumulated to provide a single figure on financial reports. You can produce custom financial statements and reports by using NorthWord in conjunction with the financial reporting section of the GeneralLedger program.

## **GENERALLEDGER ACCOUNTING FEATURES**

- Store your general ledger on one, two or three diskettes
- Define up to 900 general ledger accounts
- Flexible general ledger account code definition
- Define alphabetic or numeric departments, divisions or cost centers to suit your needs
- Store and report the net balance of transactions for every account for each of 24 months
- Store budget figures for each account for up to 12 months
- Add new general ledger accounts or modify existing ones at any time (modification of critical data is strictly controlled)
- Enter accounting transactions from virtually any source you wish
- Automatic transaction batch balancing and editing of transactions for invalid data (the program does not allow posting of invalid transactions)
- Enter up to 50 separate transaction batches at one time (the program automatically numbers the batches and the transactions within them)
- Automatic transfer of accounting entries from other ACCPAC Accounting programs such as AccountsReceivable and AccountsPayable
- Extensive error detection and validation of data by the program—easy-to-understand reporting of errors found
- Listings provide clear audit trails
- Program stores transaction details up to the limit of your disk storage
- Post and list a detailed general ledger at any time
- Purge transactions from the system automatically

- Printouts provided include batch listings, batch status report, transaction source journals, detailed general ledger and trial balance worksheet
- Automatically close income and expense accounts to retained earnings at the end of the year
- Has special provision to post transactions to the previous fiscal year after it has been closed

#### **FINANCIAL REPORTING ACCOUNTING FEATURES**

- Allows an unlimited number of report specifications
- Permits user-defined statement formatting (i.e. length and width)
- Permits user-defined dollar precision (i.e. round to nearest dollar, hundred dollars, etc.)
- Uses multiple columns within a 132 character/page width limit
- Lets user define column contents — such as, figures from any of 24 months actual or 12 months budget, the difference between two columns, a column as a percentage of another, a column as a percentage of any amount in the same or in any other column, etc.
- Permits random or sequential accumulation of general ledger accounts to form one financial statement line (rounding handled automatically)
- Has user-defined sub- and grand-totalling
- Accumulators automatically carry sub- or grand-totals forward to other statements
- Allows user-defined text to be inserted at any point
- Full user control over column and text indentation, underlining, etc.
- Automatic page numbering

#### **Accounts Payable**

With ACCPAC's Accounts Payable System, the entire bill-paying sequence — from entry of supplier invoices through automated check printing and distribution of disbursements to the general ledger — is simple, fast, and accurate. As a bonus, you have access to the aged cash requirements reports you need to avoid late charges, secure supplier discounts, and match cash requirements to cash resources. ACCPAC's Accounts Payable System is the nearest thing to making bill-paying a pleasant task.

#### **ACCOUNTSPAYABLE ACCOUNTING FEATURES**

- Stores your accounts payable ledger on one, two or three diskettes
- Establishes up to 1500 vendor accounts depending on your disk configuration
- Has flexible alphabetic or numeric vendor account code format
- Maintains vendor accounts on an open item basis
- Has easy-to-use addition, modification and deletion of vendor accounts
- Has one-time specification of general ledger accounts, commonly used for distribution of payables and check entries
- Allows entry of invoices to be paid and of adjustments (including general ledger distribution)
- Takes payment-due data and/or maximum amount to be paid
- Takes discount terms with the invoice (if desired, standard discount terms can be stored in each vendor account)
- Detects errors, has mandatory edit listings, and maintains complete audit control
- Answers immediately on the video screen any inquiries into details of amounts payable to a vendor
- Prints an aged cash requirements report with invoice details and with the aging categories you choose (you can tell the program to age the report with or without taking discounts into account)
- Lets you request a pre-payment register to ensure automatic payments are proper
- Defers payments to a specified date or makes partial payments by invoice
- Allows flexible printing specifications for checks and remittance advices
- Automatically prints checks and remittance advices for amounts due for payment — checks are automatically numbered and multiple invoices printed on each check

- Printed checks are registered automatically
- Prints a detailed aged trial balance of invoices outstanding with aging categories you specify
- Prints list of invoices which are past payment-due date
- Prints vendor lists alphabetically or by account code
- Retains the following information for each vendor: invoices outstanding, total purchases and discounts taken during the current and in the previous year, date and amount of last payment, number of outstanding transactions, and outstanding balance
- Automatically transfers accounting distributions to the ACCPAC General Ledger System

#### **Accounts Receivable**

ACCPAC's Accounts Receivable System can improve your cash collections and reduce bad debts.

With ACCPAC's Accounts Receivable System, you have at your fingertips all the tools necessary to manage accounts receivable effectively; you reduce the investment necessary in this asset, and you free cash for alternate uses.

At any time you can obtain a video display showing all details of a customer's account, print a detail (or summary) aged listing of receivables with specified aging categories, or print statements for mailing to customers. Depending on your needs, you can set up either open item or balance forward customer accounts.

#### **ACCOUNTSRECEIVABLE ACCOUNTING FEATURES**

- Stores your accounts receivable ledger on one, two or three diskettes
- Establishes up to 1500 customer accounts depending on your disk configuration
- Uses flexible alphabetic or numeric customer account code format
- Defines customer accounts as balance forward or open item
- Has flexible customer account maintenance
- Inputs invoice, cash or adjustment transactions (including general ledger distribution)
- Detects errors — mandatory edit listings and complete audit control
- Has full retention of transactions for monthly statement printing
- Answers all inquiries about account details using the video screen
- Automatically changes interest on accounts and aging categories you specify
- Retains credit limits, year-to-date sales, last year's sales, date and amount of last invoice and payment, number of outstanding transactions, etc. for each customer
- Automatically transfers accounting entries to the ACCPAC General Ledger System
- Prints summary or detailed aged trial balance with completely flexible aging calculations
- Allows flexible definition of statement format, including information placement, aging reminders, over-credit-limit reminders, etc.
- Prints a summary report of complete details about one customer or several
- Keeps journal of interest charges, printing changes when they are made
- Prints custom reminder or advertising letters to customers
- Prints customer mailing labels

Horizon and NorthWord are registered trademarks or trademark of North Star Computers, Inc.

MailManager, InfoManager, ACCPAC, GeneralLedger, AccountsReceivable and AccountsPayable are trademarks of Basic Software Group

©North Star Computers, Inc. July 1980

**NorthStar**™

**North Star Computers, Inc.**

14440 Catalina St, San Leandro, CA 94577 USA  
(415) 357-8500 TWX/Telex (910) 366-7001

00163

5M 6/81

# HORIZON HARD DISK SUBSYSTEMS

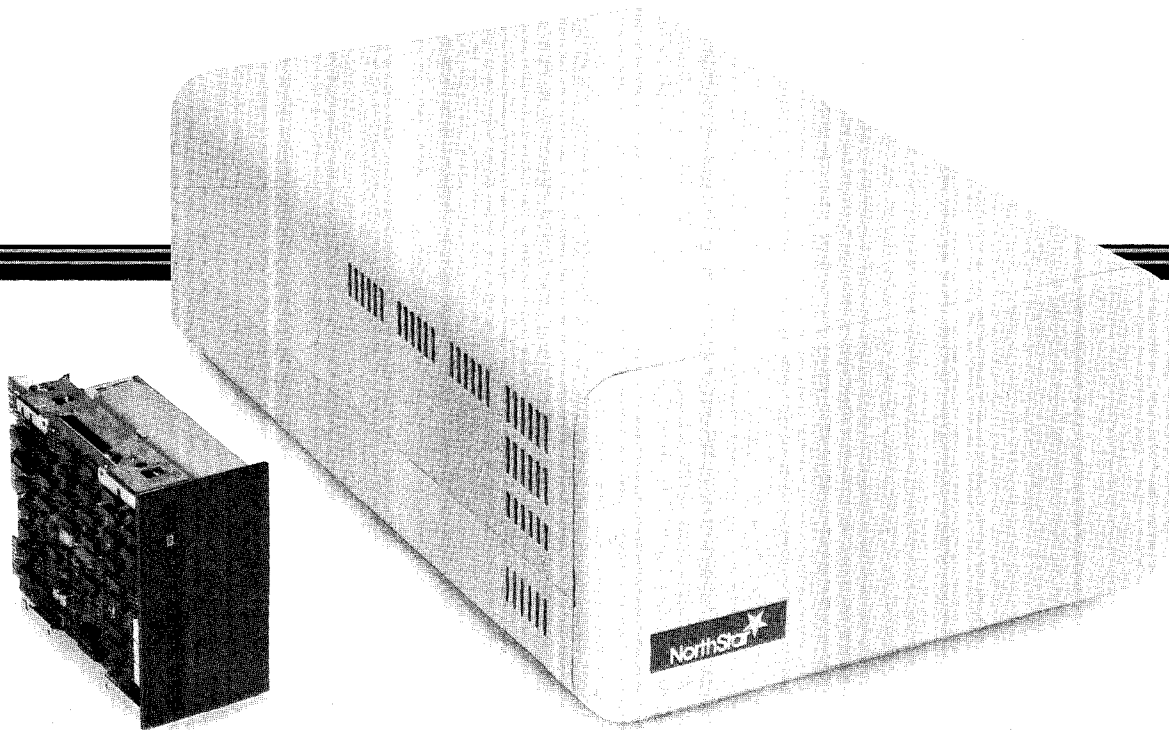

**5Mb or 18Mb Winchester Technology/Hard Disk Subsystems for HORIZON® Computers. Drives May Be Added To A HORIZON Computer, And Are Supported By All North Star Software.**

North Star provides a choice between two Winchester technology Hard Disk Subsystems as optional expansions of the HORIZON computer's storage capacity.

- The HDS-5 (5¼ inch 5Mb Hard Disk) is a low cost integrated package. The HDS-5 occupies one of the 5¼ inch floppy disk slots in the HORIZON chassis. The disk controller plugs into an S-100 bus slot in the HORIZON chassis. Power is supplied by the HORIZON power supply.
- The HDS-18 (14 inch 18Mb Hard Disk) is a high capacity external drive with integral controller enclosed in a beige metal cabinet and connected through two 15 conductor cables to the parallel I/O D connectors at the rear of the HORIZON chassis. Up to four HDS-18 drives (72Mb) can be connected to the HORIZON in a daisy chain fashion. Any controller may be configured as "middle" or "last" by jumper selection. Drives are available for 115V 60Hz or 230V 50Hz operation.

The HDS-5 is the 5¼ inch micro-Winchester providing 5Mb of formatted storage. The HDS-18 provides 18Mb of

formatted storage with an integral North Star controller. For those applications not requiring the storage capacity of the HDS-18, the HDS-5 provides the lowest cost per kilobyte of storage and the lowest cost integration with the HORIZON computer relative to capacity.

The Hard Disk Subsystems are available as add-on products to upgrade existing HORIZON computers in the field, or bundled into HORIZON systems such as the HRZ-1Q-64K-HD-5 or HRZ-1Q-64K-HD-18.

Both these Hard Disk Subsystems are supplied with Hard Disk Subsystem Software on two North Star diskettes. This software includes the following components:

- HDOS: Hard Disk Operating System which includes the Hard Disk File Management System, floppy disk and other standard peripheral device drivers.
- COMMAND PROCESSOR: This is the user interface which accepts user commands through the CRT terminal to manipulate disk files, accounts, and programs or to perform miscellaneous monitor functions.

FOLLOW THE STAR

**NorthStar** ™

- **HBASIC:** Hard Disk version of North Star BASIC allowing access to Hard Disk or floppy disk files with little or no change to BASIC programs.
- **HDCHECK:** Hard Disk Test and Formatting program which facilitates testing or formatting of Hard Disk drives.
- **BACKUP/RECOVERY SYSTEM:** This system performs quick and convenient backup and retrieval of Hard Disk using floppy diskettes. Optionally the North Star Tape Backup System is available to backup either Hard Disk Subsystem on a 13.4 Mb capacity 1/4" tape cartridge.

The documentation included with either Hard Disk Subsystem consists of the Hard Disk Subsystem User's Manual and the HBASIC Software Documentation Supplement.

In addition to the HDOS system software HDS-5/HDS-18 are supported by single and multi-user versions of North Star application software and CP/M®.

A summary of these Winchester technology Hard Disk Subsystems is as follows:

- **HDS-5**
  - 5Mb formatted capacity.
  - Fits into the 5¼ inch floppy disk slot in HORIZON chassis.
  - Lower system cost per kilobyte than floppy disks.
  - Average access time 170 msec.
  - 625 K bytes/second transfer rate.
  - Unique incremental Backup and Recovery system.
  - Fully supported by North Star System Software: CP/M, HDOS and TSS/A.

#### HDS-18

- 18Mb formatted capacity per drive.
- Expandable to 72Mb total with four drives.
- Average access time 60 msec.
- 960Kbytes/second transfer rate.
- Single platter with two read/write heads per surface (total of four per drive).
- Disk controller integrated into drive.
- Unique incremental Backup and Recovery system.
- Fully supported by North Star System Software: CP/M, HDOS, TSS/A, and PASCAL II.0.

## SYSTEM COMPONENTS

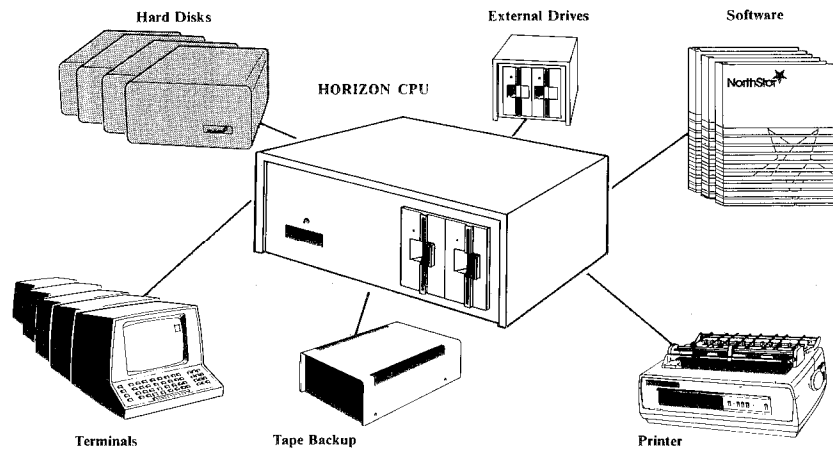

Shipping Weight 22.7 kg (50 pounds) approximately

Heat Dissipation 30W (65 BTU/HR)

#### HDS-18 PERFORMANCE SPECIFICATIONS

Formatted Capacity	
Per Drive	18 Mbytes
Per Surface	9 Mbytes
Per Track	21,504 Bytes
Per Sector	512 Bytes
Sectors/Track	42
Transfer Rate	960 Kbytes/Sec
Access Time	
Track to Track	20 msec
Average	60 msec
Maximum	130 msec
Average Latency	12.5 msec

#### HDS-18 FUNCTIONAL SPECIFICATIONS

Rotational Speed	2400 rpm
Recording Density	7545 bpi
Track Density	182 tpi
Cylinders	210
Tracks	840
R/W Heads	4
Recording Method	MFM

#### HDS-18 PHYSICAL SPECIFICATIONS

Environmental Limits	
Ambient Temperature	10°C to 40°C (50°F to 105°F)
Relative Humidity	10% to 90% (non-condensing)

AC Power Requirements	
115V 60Hz,	3.5 amps running
	12.5 amps starting
230V 50Hz,	2.0 amps running
	6.0 amps starting

Dimensions 23 cm x 43 cm x 66 cm (9 in. x 17 in. x 26 in.)

Shipping Weight 40.5 kg. (90 pounds)

Heat Dissipation 350W

#### HDS-5 PERFORMANCE SPECIFICATIONS

Formatted Capacity	
Per Drive	5.0 Mbytes
Per Surface	1.25 Mbytes
Per Track	8192 Bytes
Per Sector	512 Bytes
Sectors/Track	32
Transfer Rate	625 Kbytes/Sec
Access Time	
Track to Track	3 msec
Average	170 msec
Maximum	500 msec
Settling Time	20 msec
Average Latency	8.33 msec

#### HDS-5 FUNCTIONAL SPECIFICATIONS

Rotational Speed	3600 rpm
Recording Density	7690 bpi
Track Density	254 tpi

Cylinders	153
Tracks	612
R/W Heads	4
Recording Method	MFM

#### HDS-5 PHYSICAL SPECIFICATIONS

Environmental Limits	
Ambient Temperature	10°C to 40°C (50°F to 105°F)
Relative Humidity	20% to 80% (non-condensing)

AC Power Requirements	None
DC Power Requirements	
+ 12VDC±10%	4.5A starting
	2.0A typical
	(15 seconds max)
+ 5VDC±5%	1.0A typical

Dimensions 8.25 cm x 14.5 cm x 20.2 cm (3.25 in. x 5.75 in. x 8.0 in.)

The North Star logo and HORIZON are trademarks or registered trademarks of North Star Computers, Inc. CP/M is a registered trademark of Digital Research, Inc. Pascal II.0 is an implementation of UCSD Pascal.

FOLLOW THE STAR  
**NorthStar**™

North Star Computers, Inc. 14440 Catalina Street  
San Leandro, CA 94577, USA

©1981 North Star Computers, Inc. Contents of this publication may be changed without notice and shall not be regarded as a warranty.

# TAPE BACKUP

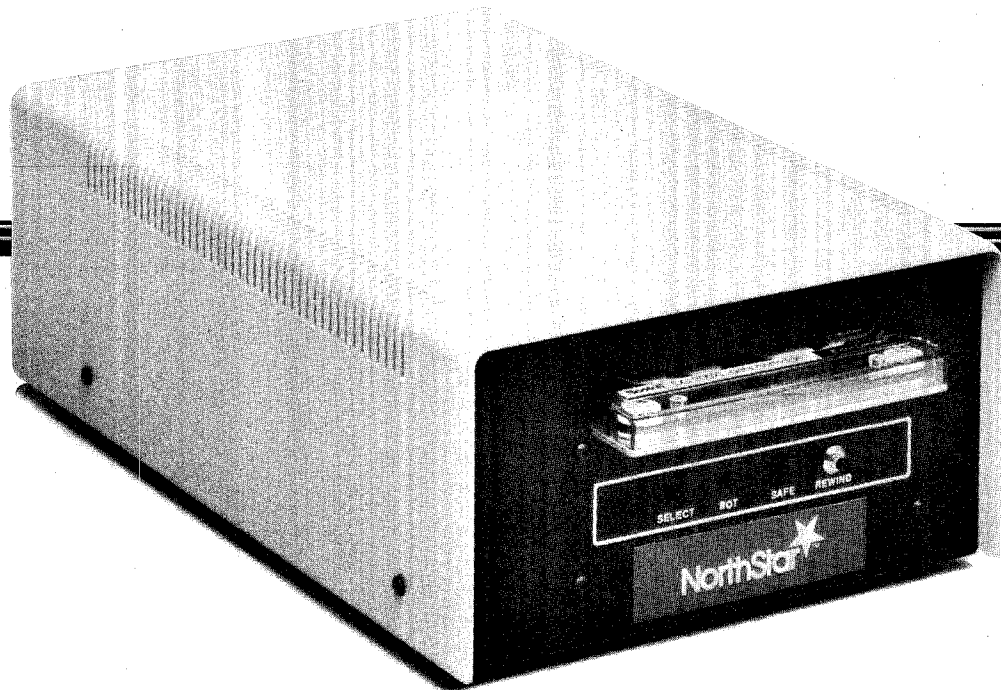

## 13.4Mb Capacity Tape Cartridge, Modular, Fast, Easy to Use Interactive Backup and Recovery Software for either 5Mb or 18Mb Hard Disk System.

The North Star Tape Backup System for backup and recovery of data on either 5Mb or 18Mb Hard Disk System. consists of a 1/4 inch tape drive housed in a metal cabinet. Each removable tape cartridge provides 13.4Mb of storage. The tape drive is connected to the HORIZON<sup>®</sup> by means of a five foot flat ribbon cable with two 25 pin "D" type connectors for convenient connection at the HORIZON back panel. An S-100 bus controller board with connecting cables and "D" connectors is also provided. The tape drive cabinet includes its own internal AC power supply. Both 115V/60 Hz and 230V/50 Hz versions are available.

Two 5 1/4 inch floppy diskettes contain the required Backup and Recovery utilities and Test/Diagnostic routines for use with CP/M<sup>®</sup>, HDOS, USCD Pascal II.0 and North Star ASP. The operation of the Tape Backup System is compatible with North Star Hard Disk software. A complete User's Manual is also supplied as part of the system.

The operation of the Tape Backup System is divided into two segments: *Backup* of files on disk to magnetic tape and *Recovery* of data from magnetic tape onto disk.

### Backup Operations

Under North Star HDOS or Pascal II.0 the user may select among four backup types:

- Complete Backup: Copies the complete contents of the disk onto tape.
- Incremental Backup: Copies all disk sectors that have been changed since the last backup was performed.
- Selective Backup by File: Copies selected files onto tape.
- Selective Backup by Account: Copies all files associated with the selected account.
- Under North Star ASP the user may select between two backup operations.
  - Complete Backup: Copies the ASP data files onto tape.
  - Selective Backup by Project: Copies all data files associated with the specified project onto tape.
- Under CP/M the backup system provides:
  - Selective Backup by File: Copies selected files onto tape.
  - Automatic Backup: Copies a pre-designated set of files onto tape.

FOLLOW THE STAR  
**NorthStar** 

## Recovery Operations

- Under North Star ASP, HDOS or Pascal II.0 the user may select between Informative Commands and Operational Commands.
  - Informative Commands: *List: Labels, Accounts or Files contained on the tape.*
  - Operational Command: *Recover: Complete, specified account or specified files. Causes the specified data on the tape to be copied onto the disk. Under ASP recovery is done by Project.*

- Under CP/M the recovery system provides:
  - Selective Recovery by File: Recovers a selected file from tape to disk.
  - Automatic Recovery: Recovers the pre-designated set of files from tape to disk.

In all cases, the system automatically verifies data immediately after it is written and signifies that the copy process has been completed accurately.

The user operates the Tape Backup System interactively by selecting the desired operation from simple menu presentations at the user's terminal. All required information is requested, prompted and validated in a friendly and easily understood fashion as the system leads the user through each backup or recovery step.

## SYSTEM COMPONENTS

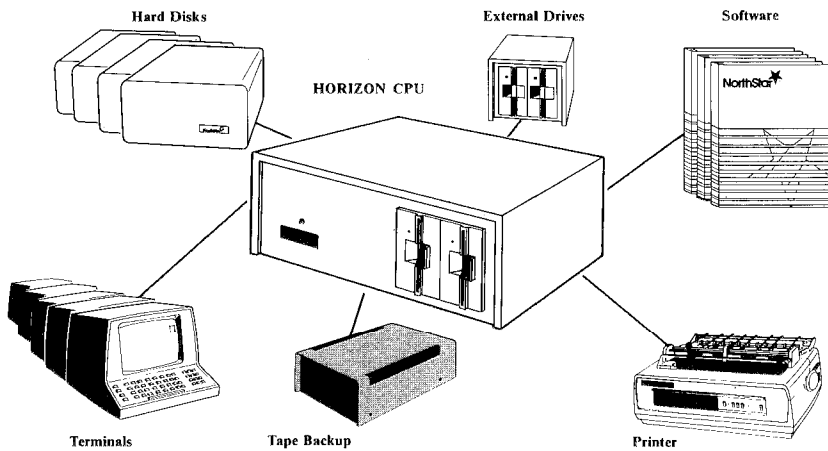

<b>Cartridge</b>	ANSI Standard X 3.55 (1977) 135 M (450 feet) DC-300XL 89 M (300 feet) DC-300A
<b>Capacity:</b>	DC-300 XL Cartridge 13.4Mb formatted DC-300A Cartridge 8.9Mb formatted
<b>Density:</b>	6400 bpi (2520 bpcm), MFM

### Physical Specifications

<b>Size:</b>	40.5 cm x 26 cm x 14.5 cm (16 in. x 10.25 in. x 5.75 in.)
<b>Weight:</b>	11.25 kg (25 pounds)

### Power Requirements

<b>115V/60 Hz:</b>	1A (standard 3 prong plug into the dedicated 20 Amp circuit used by the HORIZON)
<b>230V/50 Hz:</b>	.5A (standard 3 prong plug into the dedicated 20 Amp circuit used by the HORIZON)

### Environmental Limits

<b>Temperature:</b>	+5°C to 35°C operating (40°F to 95°F) –30°C to 60°C storage (–22°F to 140°F)
<b>Humidity:</b>	20% to 80% (non-condensing)

## Specifications

### Tape Drive

Recording Mode:	4 Track Serial
Head Type:	Dual Gap, Read-While-Write with Separate Erase
Tape Cleaner:	Integral
Tape Speeds:	30 ips (76 cm/s) Write/Bidirectional Read

Transfer Rate:	90 ips (228.6 cm/s) Bidirectional Search and Rewind 192 Kbits/Sec (24 Kbytes/Sec)
Start/Stop Time:	At 30 ips (76 cm/s): 25/26 ms At 90 ips (228.6 cm/s): 71/74 ms
Data Reliability:	One hard error in 10 <sup>9</sup> bits

The North Star logo and HORIZON are trademarks or registered trademarks of North Star Computers, Inc. CP/M is a registered trademark of Digital Research, Inc. Pascal II.0 is an implementation of UCSD Pascal.

FOLLOW THE STAR  
**NorthStar**™

North Star Computers, Inc. 14440 Catalina Street  
San Leandro, CA 94577, USA

©1981 North Star Computers, Inc. Contents of this publication may be changed without notice and shall not be regarded as a warranty.

# ADVANTAGE



**Integrated Desk Top Computer with 12 inch Bit-Mapped Graphics or Character Display, 64Kb RAM, 4 MHz Z80A<sup>®</sup>, Two Quad Capacity Floppy Disk Drives, Selectric<sup>®</sup> Style 87 Key Keyboard, Business Graphics Software**

The North Star ADVANTAGE<sup>™</sup> is an interactive integrated graphics computer supplying the single user with a balanced set of Business-Data, Word, or Scientific-Data processing capabilities along with both character and graphics output. ADVANTAGE is fully supported by North Star's wide range of System and Application Software.

The ADVANTAGE contains a 4 MHz Z80A<sup>®</sup> CPU with 64Kb of 200 nsec Dynamic RAM (with parity) for program storage, a separate 20Kb 200 nsec RAM to drive the bit-mapped display, a 2Kb bootstrap PROM and an auxiliary Intel 8035 microprocessor to control the keyboard and floppy disks. The display can be operated as a 1920 (24 lines by 80 characters) character display or as a bit-mapped display (240x640 pixels), where each pixel is controlled by one bit in the 20Kb display RAM. The two integrated 5¼ inch floppy disks are double-sided, double-density providing storage of 360Kb per drive for a total of 720Kb. The n-key rollover Selectric style keyboard contains 49 standard typewriter keys, 9 symbol or control keys, a 14 key numeric/cursor control pad and 15 user programmable function keys.

The attractive desk top chassis contains six slots for plug-in option cards: a parallel interface for printer or

other parallel devices, a serial (RS-232C) port or a North Star Floating Point Board (FPB) for substantial computational performance increase. Sufficient power (115V or 230V, 60 or 50 Hz) is also contained within the light weight chassis.

Included with the ADVANTAGE system is a system diskette containing a Business Graphics package, a complete system diagnostic program and a Graphics Demo package.

This powerful, compact and self-sufficient computer is further enhanced by a broad selection of Systems and Application software. For the business user North Star offers proprietary Application Software modules controlled by North Star's proprietary Application Support Program (ASP). For a wide variety of commercial, scientific or industrial applications North Star's graphics version of the industry standard CP/M<sup>®</sup> is offered. For the computation-intensive or graphics-intensive application North Star's powerful G-DOS with G-BASIC provides a rich set of BASIC extensions that exploit the ADVANTAGE graphics features. The following is a more detailed description of these three system software options:

**North Star ASP and Application Modules**

The North Star Application Support Program (ASP) is a high performance operating system that includes support for the ADVANTAGE features, two Quad capacity (360Kb per diskette) floppy disk drives and a serial or parallel printer (matrix or letter quality).



## ADVANTAGE Specifications

### Cabinet

#### Dimensions

48 cm x 51 cm x 31.5 cm  
(18¾ inch x 20 inch x 12½ inch)

Shipping Weight: Approximately 22.5 kg  
(50 pounds)

Net Weight: 19.5 kg (43 pounds)

Composition: High impact structural foam

### Power Requirements

Domestic: 115VAC, (95 to 135VAC), 50/60Hz  
International: 115/230VAC, (95 to 132VAC/187  
to 265VAC), 50/60Hz

Power 2 amps @ 115V

Consumption: 1 amp @ 230V

### Temperatures

Operating: 10°C to 40°C  
(50°F to 104°F)

Non-operating: -40°C to 60°C  
(-40°F to 140°F)

Shipping: -40°C to 52°C  
(-40°F to 125°F)

### Humidity:

Operating: 20% to 80% non-condensing  
Non-operating and Shipping:  
5% to 95% non-condensing

### Processor/Memory

CPU: Z80A Microprocessor  
Operating speed: 4 MHz

Intel 8035 auxiliary processor for  
keyboard and disk

Memory: 64Kb Main RAM  
20Kb Display RAM  
2Kb Boot PROM

### Video

Screen: 28 cm (12 inch) diagonal P31 phosphor  
(green)

High impact, non-glare safety shield

Standard Character Format: 1920 character  
display, 24 lines by 80 characters

5x7 character in 8x10 dot matrix

Graphics Resolution: 240 pixels high x  
640 pixels wide

Refresh Rate: 50 or 60 Hz, depending on  
line frequency

### Keyboard

Keytops: Sculptured  
11% Keyboard angle (Selectric  
compatible)

Number of Keys: 87

Key Groups: 49 Standard Typewriter Keys  
14 Key Numeric Pad with  
ENTER Key  
15 Programmable Function Keys  
9 Additional Symbol/Control  
Keys

Other features: N-key roll-over  
Full Cursor Control  
Special Shift-Lock Keys  
5 Shift Modes  
Auto Repeat

### Disk

Number of drives: Two floppy disk drives  
housed in cabinet

Diskettes: Standard 5¼ inch floppy diskettes  
512 bytes/sector, 10 (hard)  
Sectors/track, 35 tracks/side,  
2 sides/diskette

Storage capacity: Quad (double-sided,  
double-density)  
360Kb/per diskette  
(formatted)

Transfer rate: 250K bits/second

Latency: 100 ms (average)

Access Time: Track-to-Track: 5 msec

Track density: 48 tpi

Number of tracks per side: 35

Disk speed: 300 rpm ± 3.0%

### Input/Output

Slots for six plug-in boards.

Each board addressed by 16 I/O addresses.

Serial I/O: RS-232C serial port  
Current loop option  
Asynchronous: 45 baud  
to 19.2 kilobaud  
Synchronous: 2400 baud to  
51 kilobaud

Parallel I/O: 8-bit data in and out with three  
handshake lines for each port.  
Maximum speed is limited by  
the processor.

Floating Point Board (FPB): Performs high  
speed BCD float-  
ing point arith-  
metic: add,  
subtract, multiply,  
and divide.  
Up to 14 digits of  
precision  
(programmable).  
Overflow, under-  
flow, and divide  
by zero status.  
Typical 8-digit  
multiply: 80  
microseconds.  
Typical 8-digit  
divide: 156  
microseconds.

*The North Star logo, ADVANTAGE, HORIZON and NORTHWORD are trademarks or  
registered trademarks of North Star Computers, Inc.  
CP/M is a registered trademark of Digital Research.  
Z80A is the registered trademark of Zilog, Inc.  
CBASIC and MBASIC are registered trademarks of MicroSoft Consumer Products, Inc.  
Selectric is a registered trademark of International Business Machines.  
ACCPAC, MailManager and InfoManager are trademarks of Basic Software Group.*

FOLLOW THE STAR  
**NorthStar**™

North Star Computers, Inc. 14440 Catalina Street  
San Leandro, CA 94577, USA

# NorthStar<sup>TM</sup> InfoManager<sup>TM</sup>

A powerful data inquiry system has many applications in today's business environment. It can help provide doctors and dentists with complete and current patient records, publishers and service organizations with detailed subscription lists and subscriber data, businessmen and professionals with calendar management functions, and businesses with customer records. North Star Computers has created InfoManager, a data management program for the Horizon<sup>®</sup> computer. InfoManager can provide small businesses with complete and instantly accessible records information.

## **POWERFUL, EASY-TO-USE DATA MANAGEMENT**

InfoManager is a powerful data management system that, unlike a simple mailing list system, has a greatly increased capacity to store and manipulate your information. InfoManager will accept up to 50 fields of information for each record in a list; it has a numeric capability (making entry of dollar information much easier); and it has the ability to select and sort before printing. This latter function enables InfoManager to perform reporting tasks, providing a valuable management resource. The ability to extract and sort information — in any order and by multiple levels — and then print out reports and letters create a management planning capability that can greatly enhance forecasting ability in areas of sales, budgets, inventory requirements, capital requirements and so forth.

## **INFOMANAGER INCREASES OFFICE PRODUCTIVITY**

Wholesalers and retailers can use the InfoManager system as a powerful product inquiry system — including storing details or obtaining instant product information. Customers will be impressed by the speed and accuracy with which you will be able to answer their inquiries; there's no need to fumble through bulky catalogues or card files.

Maintenance of accurate customer or client records is a must for many businesses (doctor's, dentist's, accountant's and lawyer's offices, retail stores, and automotive shops, to name only a few). With InfoManager, you can retain up to 50 fields of information about each customer which can be instantly accessed via the computer's video screen. Your office can select and sort customer records by criteria, and print reminder letters, announcements of new products, mailing labels for advertising literature, etc.

With InfoManager, you can also enter information that can be used as an instant calendar reminder. At any time, you can obtain a printout of those matters to be attended to during a given period of time. If there are several individuals using such a calendar management system, you can even sort and list the matters by individual.

Companies in the construction industry find InfoManager an invaluable tool for maintaining an inventory of tools and equipment at different job sites. At any time the equipment manager can find out where a tool is, or what tools are being used on a given job. Where regular maintenance is required, InfoManager can be instructed to print a list of equipment requiring maintenance on a given day — you can even break down one piece of equipment into its many components requiring separate maintenance.

And, best of all, InfoManager can be used for several totally different data inquiry systems at the same time. Uses for InfoManager are limited only by your imagination.

## **DOCUMENTATION**

InfoManager comes with a complete User's Manual that explains all facets of the program in easy-to-understand terminology. The User's Manual includes numerous "hands-on" examples to help you learn the program's capabilities; it even provides guidance on how to use the program in several specific situations.

## **INCREASE INFOMANAGER APPLICATIONS WITH ADDITIONAL PROGRAMS**

InfoManager is part of a family of North Star Application Software programs which either function independently or in conjunction with other programs in the family. For example, use NorthWord<sup>™</sup> word processing system to create letters or fill-in-blanks forms that can be used with InfoManager. Other programs offered in the North Star Application Software line include GeneralLedger<sup>™</sup>, AccountsReceivable<sup>™</sup> and AccountsPayable<sup>™</sup>.

## **PRINCIPAL PROGRAM FEATURES:**

### **FLEXIBILITY IS THE KEYWORD FOR INFOMANAGER**

- Store a data information list on up to 3 floppy disks if you have a 4-drive system
- Create several information files with different characteristics for different purposes
- Define the data items to be included in each record when you generate your information file (you can generate many different information files)
- Specify up to 50 individual data items per record in the list
- Define a data item to be alphanumeric or strict numeric at the time of specifying the parameters of your list
- Specify the size of the data fields (each can be up to 30 positions long)

### **ENTER, STORE, MANIPULATE, AND PRINT YOUR INFORMATION WITH EASE**

- InfoManager provides a powerful "Double Key" system for record retrieval purposes — you can define any two of the data fields in a record to be the keys
- Using either of the two keys, you can locate any record in your file of information within seconds regardless of the number of records in the file, and display the data on the computer's video screen in easily-readable format
- Use the video screen to add, modify, or delete information in any record rapidly
- Delete a range of entries, or group of entries that share specific characteristics
- Obtain hard-copy echo of changes made to the information list
- Print a List Information Report at any time which provides an up-to-date status of the maximum number of records you can have in your list, the number of records presently in the list, and the space available for additional records.

### **PRINT REPORTS, LETTERS AND LABELS WITH INFOMANAGER**

- Print reports, letters and labels using the information in your information list

- Print a selected group of records or a statistical sample drawn from the list
- Print record or customer reports in sequence or individually by page
- Use InfoManager to print one or several mailing labels across a page or on label forms
- If you want to use InfoManger as a mailing list program, you have complete flexibility in defining mailing label formats (number side by side, size, and data to be printed)
- Print reports, labels and letters at high speed with a wide variety of printers

#### **MERGE INFORMATION FROM YOUR DATA FILE INTO PERSONALIZED LETTERS**

- Use the NorthWord word processing system to create an unlimited number of custom letters or forms for use with InfoManager — this feature is great for sending letters to customers or clients about whom you are keeping information
- Put easy-to-use codes in letters created with NorthWord that instruct InfoManager what information from your information list you want inserted in a letter or form, and where you want it to appear
- Information is inserted into custom letters in such a way that the letters appear to be one-of-a-kind (your clients or customers will be impressed with the personal-looking service)
- Print personalized letters for all records in your data file, or for a select group or a sample without having to reinitiate the processing of each letter (you can even attach your own letterhead to continuous forms paper for high speed printing)
- Print on single sheet paper or continuous forms
- Print tables by creating special forms with NorthWord into

which InfoManager can insert selected information from your information file

- Quick printer selection for multiple printer installations

#### **SORT INFORMATION IN YOUR DATA FILE AT HIGH SPEED**

- Prior to printing information, you can tell InfoManager to sort it into any order you want at high speed
- Specify up to five fields in a record for sorting purposes (five-level sort)
- Sort records into ascending or descending sequence
- Specify criteria for records to be selected for inclusion in the sorting process (equal to certain values, within specified ranges, etc.) — in this way you can quickly extract, and sort into meaningful order those records that have the attributes specified
- Instruct InfoManager to do several printing runs after information has been extracted and sorted

#### **LIST CAPACITIES**

InfoManager's list capacities vary with the storage capacity of the diskette, the size of the Unique (primary) and Duplicate (secondary) Keys, and the size of the list record defined. The List Capacity Table shown on the MailManager data sheet is also applicable for an InfoManager list with a Unique Key length of 30 characters and a Duplicate Key length of 6 characters.



**North Star Computers, Inc.**

1440 Fourth Street, Berkeley, CA 94710 USA  
(415) 527-6950 TWX/Telex (910) 366-7001

Horizon and NorthWord are registered trademarks or trademark of North Star Computers, Inc.

MailManager, InfoManager, ACCPAC, GeneralLedger, AccountsReceivable and AccountsPayable are trademarks of Basic Software Group.

©North Star Computers, Inc. July 1980

# NorthStar™ NorthWord™

Introducing NorthWord, the word processing program from North Star Computers . . . easy to learn, easy to use, and it gets the job done effectively and efficiently.

NorthWord was specifically designed as a word processing program for the North Star Horizon® Computer. It incorporates the most sought after features available, making NorthWord a first choice for attorneys, doctors, accountants, educators and businessmen.

## **NORTHWORD WORKS TO INCREASE YOUR OFFICE PRODUCTIVITY**

NorthWord provides a wide variety of services to assist in office automation. Documents can be stored in the computer and retrieved in part or whole for utilization in new texts. Additions and deletions can be completed at the touch of a button. Your documents can be formatted to specific criteria regulating page numbering, titles, underlining, margins, spacing, etc. And NorthWord presents a menu of activities on a video screen to make selection of activities a simple procedure. Finally, NorthWord is screen-oriented — margins, indents and justification appear on the screen precisely as they are to be printed. Practicality and simplicity are the keynotes to the success of the NorthWord program.

## **AN EASY-TO-USE PROGRAM FOR INEXPERIENCED USERS**

NorthWord was designed with first-time users in mind. For example, the program is accompanied by a sample diskette which assists the operator (through practice exercises) with the program functions. A "hands-on" approach to instruction in the NorthWord User's Manual facilitates fast and easy learning, bringing people and small computers together. To help the uninitiated (and even the experienced user), NorthWord is accompanied by a unique label that attaches above your keyboard. By defining important keys, this label eliminates the need to memorize numerous "edit codes" and "control keys."

## **DOCUMENTATION**

Simplicity is key to the instructional process and this is evidenced by the first-rate instruction and reference manual. The instruction manual is thorough and easily understood, carrying you step-by-step through the various program functions.

## **INTEGRATE NORTHWORD WITH OTHER PROGRAMS FOR INCREASED SYSTEM VERSATILITY**

NorthWord is part of the family of North Star Application Software programs which function either independently and in conjunction with other programs in the family. For example, the NorthWord word processing program can be coupled with North Star's MailManager™ mailing list program enabling mass production of correspondence, labels and reports with utmost efficiency. Other programs offered in the North Star Application Software line include GeneralLedger,™ AccountsReceivable,™ and AccountsPayable,™ all of which function separately or as a total accounting package. The integrated nature of North Star Application Software simplifies the business of adding new programs and/or the transition from one program to another. Consistent format and method of operation is maintained throughout all the programs for ease of use. As a result, training time and cost — problem areas with many computer systems — are kept to a minimum.

## **PROVEN SUCCESS**

NorthWord is in use in accounting and legal offices, in businesses and schools. Its success is the result of a simple, straightforward approach to using computers. Thoroughness and expertise of design are a guarantee of high quality, and competitive pricing assures cost efficient operation.

## **PRINCIPAL PROGRAM FEATURES:**

### **TYPE DOCUMENTS WITH EASE**

- Store up to 20 different documents on each diskette
- Identify each document with any name or number
- Have unlimited document storage on inexpensive diskettes
- Duplicate or format diskettes rapidly
- Select from menus on screen — no need to learn complex command codes
- Handle common operator mistakes with easy-to-understand instructions from the screen
- Alphabetized document index is continuously updated and displayed
- 80 character by 24 line video display
- Horizontal scrolling lets you compose and view lines up to 160 characters wide, ideal for financial reports
- Automatic margin readjustment by paragraph
- Unlimited adjustable tab stops
- Automatic carriage return, word wraparound, and justification with manual hyphenation
- Easy merging of frequently used phrases, paragraphs and mailing lists
- All documents may include comments which appear on the screen but not on the printout

### **CHANGES AND CORRECTIONS ARE EASY WITH THESE EDITING FEATURES**

- Easy insertion, deletion or alteration of text
- Easy-to-use command keys
- Instant positioning of cursor to start or end of document
- Automatic scrolling — horizontal or vertical, forward or reverse
- Single step or continuous cursor movement in four directions, home cursor, and jump to screen edges
- Jump forward or backwards by screenful of text
- Automatic search and selective replacement of words, phrases, format statements or comments (Global Search and Replace)
- Copy, move or delete in blocks of up to 20 lines
- Merge standard paragraphs into any document
- Merge and assembly text can be organized in special library documents

### **DESIGN TEXT FORMAT RIGHT ON THE SCREEN**

- Margins, indents and justification appear on the screen exactly as they will be printed
- Embedded format control statements are displayed on the screen
- Store many standard text formats to maintain document consistency
- Optional headers and footers on each page — multiple lines and location versatility
- Automatic centering of text at time of printing
- Automatic pagination divides long documents into separate pages with forced page breaks and widow elimination

- Automatic page numbering beginning with any number anywhere in the document.

#### **PRINT DOCUMENTS WITH FLEXIBILITY**

- Print one document while editing another on the screen
- Bidirectional printing
- Adjustable character and line spacing
- Boldface through multiple overstrike
- Underscore capability
- Copy can be up to 160 characters wide
- Quick printer selection for multiple-printer installations
- Printing options for skipping pages, page stops, and printing embedded statements or comments
- Option for automatic centering at print time

#### **A SUMMARY OF DOCUMENT ACTIVITIES AND PROGRAM FUNCTIONS:**

##### **DOCUMENT ACTIVITIES**

- Create (start new document)
- Remove (erase a document)
- Edit
- Select Merge (select a merge document)
- Print
- Stop Printing
- Eject Page (form feed)
- Archive (copy document to System Disk)
- Retrieve (copy archive document to Data Disk)
- Screen Print (print document on screen)

##### **EDIT KEY FUNCTIONS**

- Cursor Control (up, down, right, left, or home)
- Cursor to Edge of Screen (four directions)
- Repeat (character or cursor)
- Return (forced end of paragraph)
- Left/Right Margin Set/Release
- Tab Set/Clear
- Jump to Start/End (of document)

- Justify On/Off
- Search
- Continue Search
- Replace
- Continue Replace
- Copy Block
- Move Block
- Insert Block
- Delete Line
- Insert Split
- Center
- Close Paragraph
- Call Merge
- Reserve Blanks (through justification process)
- Escape (go from editing to Document Activity Menu)

##### **FORMAT STATEMENTS ("dot commands")**

- Pitch (horizontal space per character)
- Vertical (spacing per line)
- Spacing (double, triple, other multiples)
- Define Form Length
- Lines Per Page
- Title (running header)
- Footer (running footer)
- Header Lines (header + margin)
- Bottom Lines (footer + margin)
- Number (set or reset page number)
- Eject (force new page)
- Widow (keep lines together on page)
- Under (underline, boldface, overstrike)
- Center (at time of printing)
- Offset (on page when printing)



**North Star Computers, Inc.**

14440 Catalina St. San Leandro, CA 94577 USA  
 (415) 357-8500 TWX/Telex (910) 366-7001

Horizon and NorthWord are registered trademarks or trademark of North Star Computers, Inc.

MailManager, InfoManager, ACCPAC, GeneralLedger, AccountsReceivable and AccountsPayable are trademarks of Basic Software Group.



## **THE ACCPAC ACCOUNTING SYSTEM DELIVERS FAST, COST-EFFICIENT INFORMATION**

We at North Star have developed three complete automated accounting programs for our Horizon® computer: GeneralLedger™, AccountsPayable™ and AccountsReceivable™. When combined, these three programs comprise ACCPAC, a complete computerized accounting system for your business. With ACCPAC your accounting records are always up to date, and your financial statements and reports are tailored to your particular information needs. The more accurate, complete and accessible your accounting system is, the more timely and accurate your business decisions can be.

## **THREE ACCOUNTING PROGRAMS IN ONE EASY-TO-USE SYSTEM!**

You can start with a complete ACCPAC system or with just the one program you need most, because ACCPAC includes three self-contained programs, GeneralLedger, AccountsReceivable and AccountsPayable, that operate independently or as a fully integrated accounting system.

ACCPAC was designed by professional accountants to provide you with sound accounting controls and maximum reliability. ACCPAC's easy-to-understand programs require no knowledge of accounting or computers on your operator's part. The operator works at a typewriter-style keyboard, responding to the computer's questions and messages as they appear on the video screen.

The ACCPAC programs have many built-in safeguards against errors and loss of data. They recognize many types of errors at input time and respond by placing an error message on the screen. Furthermore, the programs check that transactions balance and that account numbers are correct before proceeding, printing easy-to-understand edit reports to let corrections be made. And, when it's advisable to make back-up copies of data to protect against loss, the program will warn the operator to do so before proceeding.

All ACCPAC programs share similar characteristics. All use similar "menus," interactive format, and messages warning against errors and data loss. You can start with one program and add the others later, or you can begin with the whole system.

## **WORD PROCESSING AND DATA MANAGEMENT SYSTEMS**

In addition to ACCPAC, we can provide NorthWord™ (our word processing system), MailManager™ (a complete mailing list system) and InfoManager™, a powerful data management system.

## **OPERATIONAL ACCPAC FEATURES**

- Each ACCPAC program comes with a detailed User's Manual which addresses both the accountant (explaining the program's accounting capabilities) and the operator (carefully describing how to operate the program, extensively utilizing "hands-on" exercises).
- All programs feature "menus." Their uniform operational style makes transfer from program to program simple.
- The programs can be used with a number of terminals and printers. The selection of each is done via the "menu."
- Copying disks is easy with the quick, "menu"-selected diskette backup routine.
- The program prompts the operator when either data is required or an error has been made.

- Easy, fill-in-the-blank video forms are used for data entry.
- The operation is program controlled throughout, including easy-to-understand error messages.

## **GeneralLedger**

To manage your business well, you need both up-to-the-minute information on daily transactions and reports, and financial statements that summarize that data in ways meaningful for decision making. ACCPAC's GeneralLedger and Financial Reporting System gives you both, quickly and accurately.

You can enter detailed transactions from almost any source — automatically transferring receivables and payables information from ACCPAC's other programs. Once transactions have been entered, the program controls the correction of errors and posting to the general ledger. At the touch of a button you can obtain such reports as batch edit listings, transaction source journals or a detailed general ledger.

The ultimate benefit of a computer-maintained general ledger management system is in the area of financial reporting. Our uniquely flexible system can be tailored to your specifications, thereby enabling you to display data in any form you choose. Now you can have information at your fingertips regarding sub-totals and totals, inclusion of written text, column format, or selection of general ledger accounts accumulated to provide a single figure on financial reports. You can produce custom financial statements and reports by using NorthWord in conjunction with the financial reporting section of the GeneralLedger program.

## **GENERALLEDGER ACCOUNTING FEATURES**

- Store your general ledger on one, two or three diskettes
- Define up to 900 general ledger accounts
- Flexible general ledger account code definition
- Define alphabetic or numeric departments, divisions or cost centers to suit your needs
- Store and report the net balance of transactions for every account for each of 24 months
- Store budget figures for each account for up to 12 months
- Add new general ledger accounts or modify existing ones at any time (modification of critical data is strictly controlled)
- Enter accounting transactions from virtually any source you wish
- Automatic transaction batch balancing and editing of transactions for invalid data (the program does not allow posting of invalid transactions)
- Enter up to 50 separate transaction batches at one time (the program automatically numbers the batches and the transactions within them)
- Automatic transfer of accounting entries from other ACCPAC Accounting programs such as AccountsReceivable and AccountsPayable
- Extensive error detection and validation of data by the program — easy-to-understand reporting of errors found
- Listings provide clear audit trails
- Program stores transaction details up to the limit of your disk storage
- Post and list a detailed general ledger at any time
- Purge transactions from the system automatically

- Printouts provided include batch listings, batch status report, transaction source journals, detailed general ledger and trial balance worksheet
- Automatically close income and expense accounts to retained earnings at the end of the year
- Has special provision to post transactions to the previous fiscal year after it has been closed

#### **FINANCIAL REPORTING ACCOUNTING FEATURES**

- Allows an unlimited number of report specifications
- Permits user-defined statement formatting (i.e. length and width)
- Permits user-defined dollar precision (i.e. round to nearest dollar, hundred dollars, etc.)
- Uses multiple columns within a 132 character/page width limit
- Lets user define column contents — such as, figures from any of 24 months actual or 12 months budget, the difference between two columns, a column as a percentage of another, a column as a percentage of any amount in the same or in any other column, etc.
- Permits random or sequential accumulation of general ledger accounts to form one financial statement line (rounding handled automatically)
- Has user-defined sub- and grand-totalling
- Accumulators automatically carry sub- or grand-totals forward to other statements
- Allows user-defined text to be inserted at any point
- Full user control over column and text indentation, underlining, etc.
- Automatic page numbering

#### **AccountsPayable**

With ACCPAC's AccountsPayable System, the entire bill-paying sequence — from entry of supplier invoices through automated check printing and distribution of disbursements to the general ledger — is simple, fast, and accurate. As a bonus, you have access to the aged cash requirements reports you need to avoid late charges, secure supplier discounts, and match cash requirements to cash resources. ACCPAC's AccountsPayable System is the nearest thing to making bill-paying a pleasant task.

#### **ACCOUNTSPAYABLE ACCOUNTING FEATURES**

- Stores your accounts payable ledger on one, two or three diskettes
- Establishes up to 1500 vendor accounts depending on your disk configuration
- Has flexible alphabetic or numeric vendor account code format
- Maintains vendor accounts on an open item basis
- Has easy-to-use addition, modification and deletion of vendor accounts
- Has one-time specification of general ledger accounts, commonly used for distribution of payables and check entries
- Allows entry of invoices to be paid and of adjustments (including general ledger distribution)
- Takes payment-due data and/or maximum amount to be paid
- Takes discount terms with the invoice (if desired, standard discount terms can be stored in each vendor account)
- Detects errors, has mandatory edit listings, and maintains complete audit control
- Answers immediately on the video screen any inquiries into details of amounts payable to a vendor
- Prints an aged cash requirements report with invoice details and with the aging categories you choose (you can tell the program to age the report with or without taking discounts into account)
- Lets you request a pre-payment register to ensure automatic payments are proper
- Defers payments to a specified date or makes partial payments by invoice
- Allows flexible printing specifications for checks and remittance advices
- Automatically prints checks and remittance advices for amounts due for payment — checks are automatically numbered and multiple invoices printed on each check

- Printed checks are registered automatically
- Prints a detailed aged trial balance of invoices outstanding with aging categories you specify
- Prints list of invoices which are past payment-due date
- Prints vendor lists alphabetically or by account code
- Retains the following information for each vendor: invoices outstanding, total purchases and discounts taken during the current and in the previous year, date and amount of last payment, number of outstanding transactions, and outstanding balance
- Automatically transfers accounting distributions to the ACCPAC GeneralLedger System

#### **AccountsReceivable**

ACCPAC's AccountsReceivable System can improve your cash collections and reduce bad debts.

With ACCPAC's AccountsReceivable System, you have at your fingertips all the tools necessary to manage accounts receivable effectively; you reduce the investment necessary in this asset, and you free cash for alternate uses.

At any time you can obtain a video display showing all details of a customer's account, print a detail (or summary) aged listing of receivables with specified aging categories, or print statements for mailing to customers. Depending on your needs, you can set up either open item or balance forward customer accounts.

#### **ACCOUNTSRECEIVABLE ACCOUNTING FEATURES**

- Stores your accounts receivable ledger on one, two or three diskettes
- Establishes up to 1500 customer accounts depending on your disk configuration
- Uses flexible alphabetic or numeric customer account code format
- Defines customer accounts as balance forward or open item
- Has flexible customer account maintenance
- Inputs invoice, cash or adjustment transactions (including general ledger distribution)
- Detects errors — mandatory edit listings and complete audit control
- Has full retention of transactions for monthly statement printing
- Answers all inquiries about account details using the video screen
- Automatically changes interest on accounts and aging categories you specify
- Retains credit limits, year-to-date sales, last year's sales, date and amount of last invoice and payment, number of outstanding transactions, etc. for each customer
- Automatically transfers accounting entries to the ACCPAC GeneralLedger System
- Prints summary or detailed aged trial balance with completely flexible aging calculations
- Allows flexible definition of statement format, including information placement, aging reminders, over-credit-limit reminders, etc.
- Prints a summary report of complete details about one customer or several
- Keeps journal of interest charges, printing changes when they are made
- Prints custom reminder or advertising letters to customers
- Prints customer mailing labels

Horizon and NorthWord are registered trademarks or trademark of North Star Computers, Inc.

MailManager, InfoManager, ACCPAC, GeneralLedger, AccountsReceivable and AccountsPayable are trademarks of Basic Software Group

© North Star Computers, Inc. July 1980

**NorthStar**™

**North Star Computers, Inc.**

1440 Fourth Street, Berkeley, CA 94710 USA  
(415) 527-6950 TWX/Telex (910) 366-7001

# NORTH STAR APPLICATIONS PACKAGES

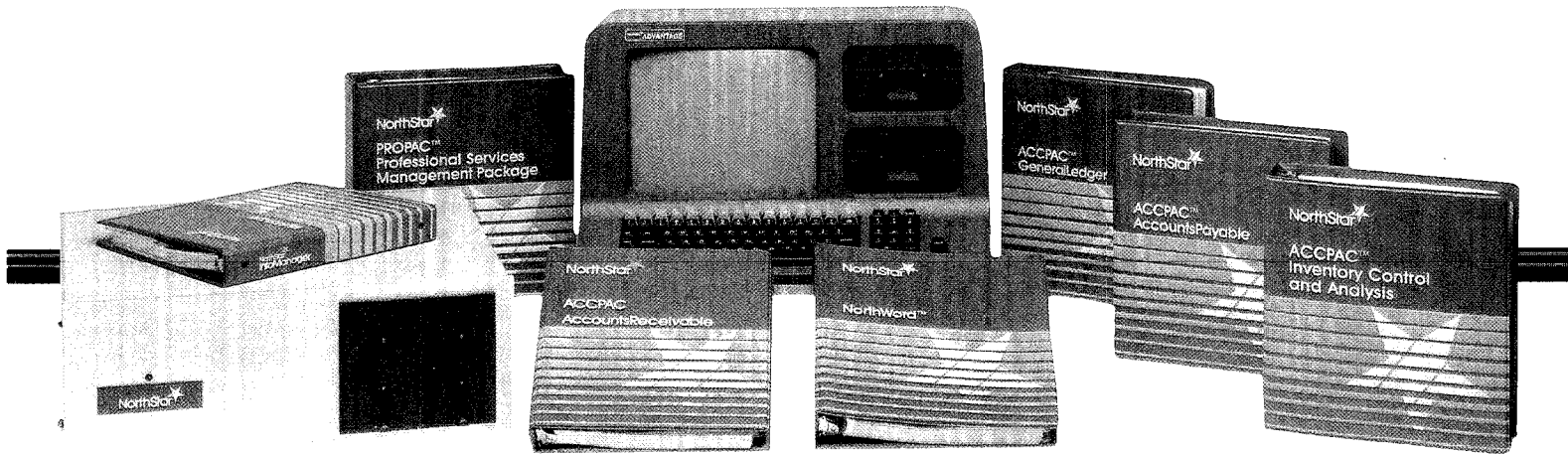

North Star offers a set of integrated business application packages that have been proven by thousands of hours of business use. These word processing, information management and accounting programs feature:

- **Ease of use.** Clear prompts, thorough manuals and sample data diskettes provide an environment that is friendly to first-time users and professionals alike. Integration. Each package can stand alone or be used in combination with others to produce financial reports, personalized form letters, etc.
- **Performance.** Speed of execution, effective use of disk space and long-term reliability have been demonstrated by independent expert evaluations.

These application programs are backed by the same high standards as North Star hardware products, giving assurance of their cost-effectiveness, hardware compatibility and high quality.

## NorthWord™

NorthWord is the easy to learn, easy to use word processing program designed to increase your office productivity. For first-time users it comes with a "hands-on" self-teaching manual and sample diskette. A unique keyboard label eliminates the need to memorize control keys.

NorthWord's principal features include:

insert	search	format	underline	justify
delete	replace	merge	boldface	center
repeat	correct	move	overstrike	tab

NorthWord also provides these automatic facilities:

scrolling	headers	carriage return
jumping	footers	word wraparound
homing	pagination	bidirectional printing

NorthWord functions together with the other North Star Application Software programs to produce financial reports, personalized mailing pieces, checks, statements, etc. All these versatile functions are available at the touch of a few keys.

## InfoManager™

InfoManager is a powerful data management system which is used for managing mailing lists, but which has a greatly increased capacity over a mailing system to store and manipulate your information. InfoManager will accept up to 50 items of information for each record in a list. It has numeric capability and the ability to select, extract and sort information by several levels.

A subset of InfoManager functions as a complete mailing list program that lets you:

- Insert and revise names in any sequence, while maintaining alphabetical or zip code order.
- Review status of each name on video screen.
- Subdivide list to reach specific groups or statistical samples.
- Insert information from mailing list into custom letters so they appear to be one of a kind (together with NorthWord).

As a data management system, InfoManager can further be used for:

- Management planning (budgets, forecasts, requirements)
- Record maintenance (customers, inventory, financial)
- Table generation
- Calendar management
- Multiple sort (up to five levels)
- Report formatting and printing

InfoManager can be used for several totally different data inquiry systems at the same time. Its uses are limited only by your imagination.

## ACCAPAC™

The more accurate, complete and accessible your accounting system is, the more timely and accurate your business decisions can be. ACCAPAC is an accounting system which contains four completely automated accounting programs: GeneralLedger; AccountsPayable; AccountsReceivable; and InventoryControl and Analysis.

FOLLOW THE STAR  
**NorthStar**™



All are self-contained programs which operate independently or as a fully integrated system.

ACCPAC was designed by professional accountants to provide sound accounting controls and maximum flexibility. The programs are easy to understand and require little knowledge of accounting or computers on the operator's part. There are many built-in safeguards against errors and loss of data. The programs check that transactions balance and that account numbers are correct before proceeding, and leave a detailed hard-copy audit trail.

### **GeneralLedger and Financial Reporting**

GeneralLedger provides up-to-the-minute information on daily transactions and reports, and financial statements that summarize the data in ways meaningful for decision making.

You can enter detailed transactions from almost any source. The program controls the correction of errors and posting to the G/L. At the touch of a key you can obtain such reports as batch edit listings, transaction source journals or a detailed general ledger.

The ultimate benefit is in the area of financial reporting. You can produce custom financial statements and reports by using NorthWord in conjunction with the Financial Reporting section of the GeneralLedger program.

### **AccountsPayable**

With AccountsPayable, the entire bill-paying sequence—from entry of invoices through automated check printing and distribution of disbursements to the general ledger—is simple, fast and accurate. You have access to the aged cash requirements reports you need to avoid late charges, secure supplier discounts, and match cash requirements to cash resources. AccountsPayable is the closest thing to making bill-paying a pleasant task.

### **AccountsReceivable**

AccountsReceivable can improve your cash collections and reduce bad debts. You have at your fingertips the tools necessary to manage accounts receivable effectively, reduce the investment necessary in this asset, and free cash for alternate uses.

At any time, you can obtain a video display showing details of a customer's account, print a detail (or summary) aged listing of receivables with specified aging categories, or print statements for mailing to customers. You can choose to set up either open item or balance forward customer accounts.

### **InventoryControl and Analysis**

InventoryControl and Analysis is a comprehensive set of programs which maintains detailed perpetual inventory

records and provides timely information to manage inventory effectively. It integrates fully with AccountsReceivable and transfers accounting data to GeneralLedger.

InventoryControl and Analysis allows you to:

- do inventory analysis with a choice of "moving-average," "FIFO" or "LIFO" costing methods
- select relevant inventory information to be kept (from more than 50 fields)
- specify up to 999 inventory categories or departments
- keep history in units, sales dollars and cost for prior year, current year-to-date, current period, and last four quarters
- automatically update records as goods are received and create an audit file
- receive full information on any item on the display screen
- generate a wide variety of reports, from price lists and profitability analyses to shelf labels.

### **PROPAC™**

PROPAC is a three-module set of programs for business professionals who bill by the hour. It consists of Client Profiles, Client Time and Billing, and Client Receivables. PROPAC is fully compatible with North Star's other business software packages.

PROPAC's Client Profiles Module analyzes billable and non-billable professional time, quickly enabling management to pinpoint problem areas. It allows for cross-reference reports and listings of basic client information such as contact names and addresses, finance charges, interest indicators and work in progress status. Overtime, activity, billable productivity and other reports are kept for each individual in the firm, automatically.

The Client Time and Billing Module automatically turns an entire staff's individual time records into finished invoices. The system keeps track of time measured in 10ths of hours, and calculates billable time using different hourly rates.

The third module, Client Receivables, maintains accounts receivables on a balance forward basis by client and provides for the entry of cash payments and adjustments. This data can automatically be posted to North Star's other financial/business software programs such as GeneralLedger and the Financial Reporting package. Journals are printed and complete audit trails are available.

### **Additional Packages**

North Star is committed to expansion of its line of application packages, with programs such as Order Entry, Spread Sheet Planning, Payroll, etc. Please check with your dealer for new announcements.

The North Star Logo, PROPAC and NorthWord are trademarks of North Star Computers, Inc.  
ACCPAC and InfoManager are trademarks of Basic Software Group, Ltd.  
Specifications subject to change without notice.

**FOLLOW THE STAR**  
**NorthStar**™

North Star Computers, Inc. 14440 Catalina Street  
San Leandro, CA 94577, USA

© 1982 North Star Computers, Inc. Contents of this publication may be changed without notice and shall not be regarded as a warranty. World Rights Reserved.



Microcomputer Specialists, Inc.  
18 Lyman Street, Westboro, Massachusetts 01581  
Telephone: (617) 366-1200

HARDWARE

## Model AD488 Interface Module

**Instrumentation Users:  
Put your North Star ADVANTAGE on the Bus.**

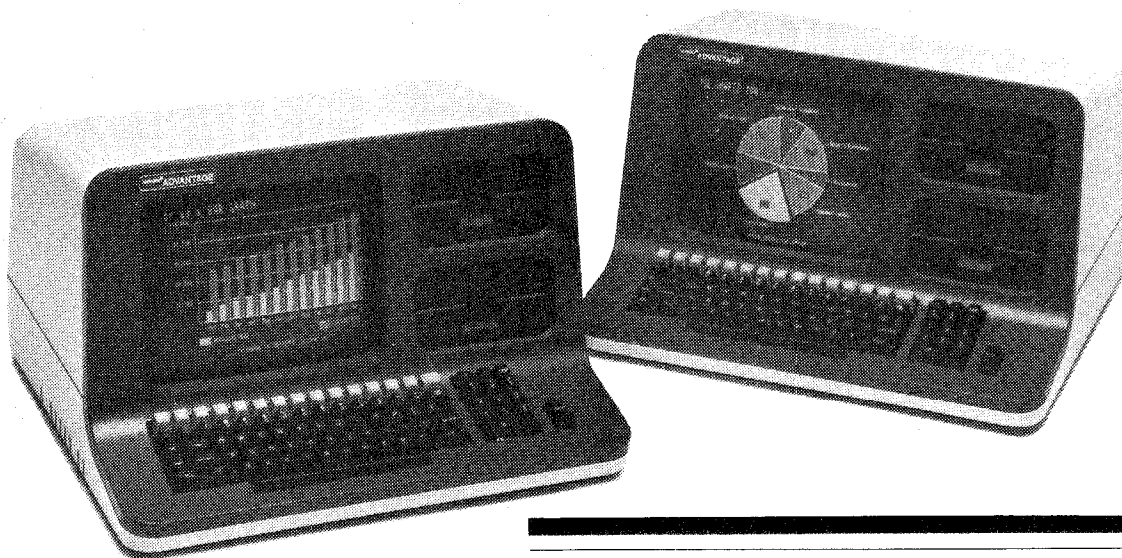

Connect your computer to thousands of industry standard devices.

The Model AD488 Interface Module allows your North Star ADVANTAGE computer to function as an intelligent talker/listener/controller fully compliant with the IEEE-488 GPIB, specification.

Diagnostic software and interface source code diskette is available.

For more information on the AD488 Interface Module call us or write.

### AD488 Interface Module Features:

- Automatic Addressing and Handshake Protocol
- Programmable Data Transfer Rate
- Complete Source/Acceptor Handshake
- Primary & Secondary Address Recognition
- Full Implementation of Transfer Control Protocol
- Synchronous Control Seizure
- Interrupt or Polled Response
- Interface Clear Sending Capability
- End of Sequence Message Recognition

**MICROCOMPUTER  
SPECIALISTS, INC.**



Microcomputer Specialists, Inc.  
18 Lyman Street, Westboro, Massachusetts 01581  
Telephone: (617) 366-1200

## Model AD512 Interface Module

### High Resolution Analog Measurements: A New Option for your North Star ADVANTAGE.

Microcomputer Specialists, Inc. announces the development and availability of the Model AD512 Analog Input Module, designed especially for the North Star ADVANTAGE computer.

The Model AD512 Interface Module is a high speed Analog to Digital converter board that fits right into the ADVANTAGE, occupying one of the available I/O slots.

A 37-pin D-type connector provides eight analog input channels. The selected input signal is stored in a high-speed sample-and-hold circuit and is converted to a 12 bit binary number.

A simple software interface selects the desired input channel and initiates the conversion with a single output command. The module signals completion of the conversion by setting a status bit which can either be polled or used to interrupt the processor. Conversion takes less than 50 microseconds.

For applications where 8 bit resolution is sufficient, the high order 8 bits can be read from the converter in one byte. When required, the low order 4 bits can be read in a second byte.

The Model AD512 Interface Module uses the latest monolithic and hybrid integrated circuit technology to achieve accuracy and speed at an affordable price.

For more information on the AD512 Interface Module call us or write.

#### AD512 Interface Module Features:

##### Multiple Input Channels

- Up to 8 Multiplexed Input Signals

##### Flexible Input Levels

- 0 to +10 volts Unipolar/Bipolar
- 0 to +20 volts Unipolar/Bipolar

##### Simple Software Interface

- Write Channel and Start Conversion
- Read Converter Status
- Read Converter High Byte
- Read Converter Low Byte

##### Selectable Interface Response

- Poll for Conversion Status
- Interrupt on Conversion Complete

##### High Resolution

- 8 Bits - 40 millivolts
- 12 Bits - 2.5 millivolts

##### Fast Conversion

- Less than 50 microseconds

**MICROCOMPUTER  
SPECIALISTS, INC.**



Microcomputer Specialists, Inc.  
18 Lyman Street, Westboro, Massachusetts 01581  
Telephone: (617) 366-1200

HARDWARE

## Model AD503 Prototype Board

**Prototype your own hardware interfaces for the North Star ADVANTAGE.**

Microcomputer Specialists, Inc. announces the availability of the Model AD503 Prototype Board for developers of custom hardware interfaces for the North Star ADVANTAGE.

The Model AD503 is specifically designed to speed development of analog and digital circuitry. It is ideal for breadboarding, prototyping, and hand-wired final products.

For more information on the AD503 Prototype Board call us or write.

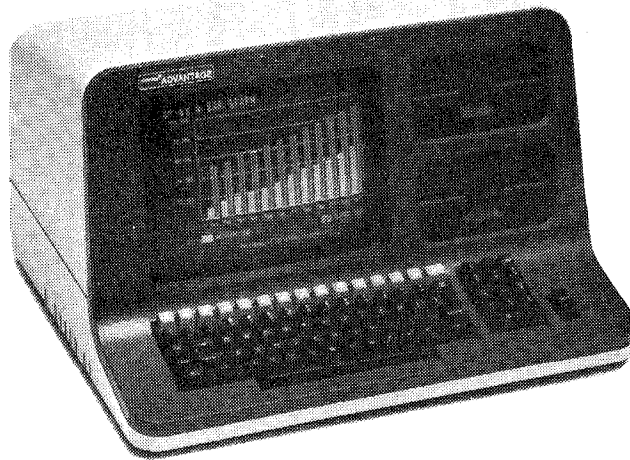

### AD503 Prototype Board Features:

**High Current Power Bus**

Extra heavy etch along the entire perimeter of the board insures effective distribution of Vcc and Ground. Provisions are made for multiple decoupling capacitors and filters.

**Versatile I/O Connector**

An industry standard 37-pin D-type connector is included for easy connection to external devices. The I/O connector also serves to mechanically lock the

Prototype Board in the ADVANTAGE's bus slot.

**Special I/O Headers**

All Model AD503 I/O signals are routed through male wire-wrap headers (0.025 inch square posts) which can be installed on either side of the Prototype Board. For analog or discrete circuits, these headers may be discarded.

**Flexible Component Grid**

A grid of 0.042 inch dia.

holes on 0.400 inch centers will accept wire-wrap sockets, T42 component clips, or can be used for point-to-point soldered connections.

**High Quality Construction**

The Model AD503 is constructed of 0.062 inch G10 epoxy glass with tin plated 2 ounce copper etch. The I/O fingers are gold plated for reliable connection.

**MICROCOMPUTER  
SPECIALISTS, INC.**



Microcomputer Specialists, Inc.  
18 Lyman Street, Westboro, Massachusetts 01581  
Telephone: (617) 366-1200

SOFTWARE

## ReCal Financial Forecasting System

... joins the family of North Star Application Software.

### Develop Complex Financial Forecasts:

ReCal allows you to define a custom forecast report. A powerful built-in editor helps you specify the format of a report up to 255 lines long and as many as 26 columns wide. Define the relationship of one report value to another. Process and print the report using up-to-the-minute input data. Perfect for those "what if" reports that model your financial future.

### Interface Directly to your North Star General Ledger System:

Financial data from your North Star General Ledger system can be accessed directly by the ReCal Financial Forecasting system. This means revenue forecasts, profit projections, and cash flow analyses can be produced on the spot, automatically.

### Transfer your Report to Northword Word Processing:

ReCal reports can be transferred to NorthWord,\*\* the North Star word processing system. There, you may edit your reports and integrate them with other word processing documents.

### The Total Financial System:

No other computer system offers such a complete selection of fully integrated financial software.

### Available for your North Star Computer:

- ACCPAC† General Ledger
- Financial Reporting
- Accounts Payable
- Accounts Receivable, and now . . .
- ReCal Financial Forecasting

For more information on the ReCal Financial Forecasting System call us or write.

\*\*NorthWord is a trademark of North Star Computers, Inc.  
†ACCPAC is a trademark of Basic Software Group.  
\*ReCal is a trademark of Microcomputer Specialists, Inc.

### ReCal Financial Forecasting System Features:

#### Versatile Arithmetic Operators

- Addition
- Subtraction
- Multiplication
- Division
- Summation
- Percentage

#### Powerful Calculation Operators

- Prompting For Values
- Auto Repeat Ranging

- Macro Definitions
- Temporary Registers
- Wild Cards

#### Flexible Format Effectors

- Title Centering
- Underlining
- Decimal Specifications
- Dollar Format
- New Page
- Line Skips
- Rounding

**MICROCOMPUTER  
SPECIALISTS, INC.**



Microcomputer Specialists, Inc.  
18 Lyman Street, Westboro, Massachusetts 01581  
Telephone: (617) 366-1200

SOFTWARE

## MISys Manufacturing Inventory System

... a new application software package  
for your North Star Computer.

MISys, a sophisticated inventory management program, has been developed for the small to medium sized manufacturer who stocks common parts, subassemblies and finished goods.

The system is designed for the non-technical operator and offers all the flexibility and power necessary to meet even the most demanding manufacturing inventory requirements.

- Inventory Control:**  
Maintains detailed information on all inventory items including quantities, costing and statistical data.
- Bill of Material Processing:**  
Extensive BOM inquiry and explosion functions permit rapid materials access and transfer.
- Purchase Order Processing:**  
Purchase order subsystem designed to aid buyers in ordering, expediting and acquiring raw materials.

MISys provides many labor saving functions necessary for prudent inventory management. The system can anticipate answers to speed up

data input and checks for erroneous entries wherever possible. Special features allow multiple users simultaneous access to the inventory data.

For more information on the MISys package call us or write.

### MISys Manufacturing Inventory System Features:

- Complete data kept on every inventory item and assembly
  - Comprehensive vendor data including multiple vendors for each inventory item
  - Rapid material transfer functions with mandatory audit trail
  - Purchase order processing subsystem includes printing of customized purchase orders
  - Archiving of purchase order histories
  - Quick access to physical inventory counts
  - High-speed inventory adjustments
  - Simultaneous, multi-user access
  - Separate material and labor cost reporting
  - Extensive error checking and protection
  - Menu driven for ease of use
- Hardware Requirements:**
- North Star HORIZON or ADVANTAGE computer with 5 MByte or 18 MByte Hard Disk
  - TSS/A Multi-User Operating System is required for multi-user access to MISys database

**MICROCOMPUTER  
SPECIALISTS, INC.**

MICROCOMPUTER SPECIALISTS, INC.  
18 LYMAN STREET  
WESTBORO, MASSACHUSETTS 01581  
(617) 366-1200

DEALER PRICE LIST  
JULY 1, 1982

ReCal Financial Forecasting Revision 2.0.0		
Quantity 1 (End User List Price)		499.00
Quantity 1 (Dealer Net)		349.00
MISys Manufacturing Inventory Revision 1.0.0		
Quantity 1 (End User List Price)		5000.00
Quantity 1 (Dealer Net)		3500.00
AD488 IEEE Interface Module for North Star Advantage		
Quantity 1 (End User List Price)		395.00
Quantity 5 (Dealer Net)		275.00
Quantity 25 (OEM Net)		245.00
Quantity 50 (OEM Net)		235.00
AD488 Diagnostic & Sample Code Disk		50.00
AD512 A/D Converter Module for North Star Advantage		
Quantity 1 (End User List Price)		495.00
Quantity 5 (Dealer Net)		349.00
Quantity 25 (OEM Net)		319.00
Quantity 50 (OEM Net)		299.00
AD512 Diagnostic & Sample Code Disk		50.00
AD407 D/A Converter Module for North Star Advantage		
Quantity 1 (End User List Price)		395.00
Quantity 5 (Dealer Net)		275.00
Quantity 25 (OEM Net)		245.00
Quantity 50 (OEM Net)		235.00
AD503 Prototype Board for North Star Advantage		
Quantity 1 (End User List Price)		99.00
Quantity 5 (Dealer Net)		85.00
Quantity 25 (OEM Net)		75.00
Quantity 50 (OEM Net)		70.00
AD613 Real Time Calendar/Clock for North Star Advantage		
Quantity 1 (End User List Price)		395.00
Quantity 5 (Dealer Net)		275.00
Quantity 25 (OEM Net)		245.00
Quantity 50 (OEM Net)		235.00
AD613 Diagnostic & Sample Code Disk		50.00

# 4 North Star Product Details

---

## Introduction

The previous sections provide an overview of North Star Computers, Inc. as a company, North Star's market focus and an outline of its major products and how these products fit together to form expandable/flexible systems. Those sections should be used for quick reference (to configure a system for example) once you are familiar with the product details presented in this section. The previous sections also serve as an introduction or "road map" to guide you through the detail provided within this section particularly when this Manual is utilized as a sales training tool.

This section identifies detailed specifications, key sales points, configuration rules and pricing for each North Star product. Its organization is:

### **Product Details (Data Sheets)**

- North Star ADVANTAGE Computer
- HORIZON® Computer
- Hard Disk Subsystems
- Tape Backup
- Multi-User HORIZON Systems — TSS/5 & TSS/18
- North Star Applications Packages
- NS-3510 Printer
- NS-100 Printer

### **Product Reviews**

- Dataquest Research Newsletter



# 5 North Star Policies and Procedures

---

## Introduction

This section defines the Policies and Procedures that establish the day to day interface between an Authorized Dealer and North Star Computers, Inc.

Policies and Procedures relating to technical support are operationally distinct and are included in their own Section 7. Policies and Procedures relating to the North Star Cooperative Advertising Program are provided in Section 6.

This section provides detailed descriptions of the Policies and Procedures. The organization of this section is:

- Contracts
- Where to Call for Assistance
- Purchase Order Policies and Procedures
- Credit Policies and Procedures

# 5 North Star Policies and Procedures

---

## Contracts

### Authorized Dealer Agreement

Every Authorized North Star Dealer attains its "AUTHORIZED" status by executing the *North Star Authorized Dealer Agreement* and the *Dealer Information Form* included herein. The status of Authorized North Star Dealer entitles you to receive the following:

1. Authorized Dealer Manual.
2. North Star Decal.
3. North Star Literature, Posters and other Point of Sale Materials. (See Section 6)
4. Inclusion in the List of Dealers for the purpose of directing leads generated by Corporate Advertising, Public Relations and Trade Shows. (See Section 6)
5. Participation in the Co-op Advertising Program. (See Section 6)
6. Participation in North Star's Service Program. (See Section 7)
7. Monthly Dealer Newsletter and Authorized Dealer Manual Updates. (See Section 6)

### North Star Dealer Purchase Agreement

As an **Authorized North Star Dealer** you will purchase through your local Authorized Distributor unless you elect and qualify for execution of the **North Star Direct Dealer Purchase Agreement** included herein. The requirements for qualification to enter into this Direct Dealer Contract are as follows:

1. **Commitment** to purchase and take delivery of a minimum of three computers per month (36 total per year).
2. **Satisfactory financial position** consistent with the committed level of purchases as specified in the contract (36 per year minimum).
3. **Facilities, personnel and image** consistent with the committed level of purchases.

# 5 North Star Policies and Procedures

---

## Whom To Contact For Information

North Star Computers, Inc.: (415) 357-8500

---

### Order Information

Price information, delivery quote, ordering procedures, return authorization (RMA numbers) & checking repair status:

*Sales Administrator*

9am-5pm Pacific Time

8am-4pm Pacific Time for Eastern Region Administrator

---

### Advertising

Co-op advertising information, advertising materials, trademark guidelines, questions regarding leads, trade show support & sales literature:

*Marketing Communications Department*

---

### Seminar Information

Seminar registration for Application Software, System Software, Hardware, Hard Disk System and System Sales Training:

*Product Marketing Department—Seminar Registrar*

---

### Product Assistance

Contract inquiries & product information:

*Regional Sales Representative*

*Coordinator Dealer Sales*

*National Sales Manager*

---

### Dealer Sales Support

*Coordinator Dealer Sales or Regional Sales Representative*

---

### Technical Assistance Hardware or Software

Maintenance questions, system interface assistance, Quality Control Reports & Software questions.

*Technical Support Line*

(415) 357-6990

8:30am-3:00pm Pacific Time

or

*Proxima—Computerized Bulletin Board*

(415) 357-1130

24 Hours

---

### Accounting

Credit memos, debit memos & payment discrepancies:

*Credit and Collection Supervisor or Credit Manager*

---

# 5 North Star Policies and Procedures

---

## Direct Dealer Ordering Procedures

If you have entered into the Direct Dealer Purchase Agreement, and are purchasing product directly from North Star Computers, Inc., there are specific policies and procedures that you should clearly understand and follow to assure a smooth operational relationship with North Star.

The process of entering into Dealer Purchase Agreement will establish the normal case of:

1. Discount Level
2. Shipping Instructions
3. Ship-to/Bill-to Locations
4. Six Month Order Forecast
5. Credit Limit and Payment Terms
6. An Assigned North Star Sales Administrator
7. North Star Dealer Number

To place an order with North Star Computers, Inc.:

1. **Mail** a written Purchase Order to:

Your Sales Administrator  
North Star Computers, Inc.  
14440 Catalina Street  
San Leandro, CA 94577

**Alternatives:**

- TWX #(910) 366-7001  
Addressed to your Sales Administrator.
  - Telex #(910) 366-7001
  - Mail Gram
2. Written Purchase Order **must contain** as a minimum:
    - (A) Part Number, Quantity, Description
    - (B) Price (net)
    - (C) Requested Delivery Date
  3. **Optional specifications** for a specific order:
    - (A) Alternate Ship To
    - (B) Special Shipping Instructions<sup>1</sup>
    - (C) "RUSH"

---

<sup>1</sup> Note: Drop Shipment to end customer is prohibited by contract.

# 5 North Star Policies and Procedures

---

## Direct Dealer Ordering Procedures

You will receive an Order Acknowledgment (copy included below) reflecting the contents of your original order. Please check that this Acknowledgment accurately reflects your order and any special instructions. If there is a discrepancy, immediately call your assigned Sales Administrator.

To expedite or validate the scheduled Ship Date as shown on the Order Acknowledgment, call your Sales Administrator.

### Additional North Star Purchase Order Policies

1. Minimum single order net value is \$200.00 for catalog items, small parts single order net minimum value is \$50.00.
2. North Star reserves the right to ship orders up to ten days prior to scheduled ship date unless specifically otherwise instructed in writing.
3. North Star will make every effort to ship orders on or before the scheduled ship date.
4. All orders are subject to the Terms and Conditions of Sale printed on the back of your Order Acknowledgment. (A copy is included in this section.)
5. All requests for delayed shipment must be submitted in writing to your Sales Administrator. Penalty charges, if any, will be assessed in accordance with your Dealer Purchase Agreement.
6. Products returned without previous Returned Material Authorization (RMA) will be refused at our dock and will be returned to the Dealer at the Dealer's expense. Procedures for requesting and obtaining an RMA for specific allowable reasons are explained in Section 7.

### See Section 6 regarding:

- Training Seminars
- Literature
- Sales Leads
- Sales Support
- Co-op Advertising

### See Section 7 regarding

- Service/Repair
- Warranty/R. M. A.
- Telephone Technical Support

# 5 North Star Policies and Procedures

---

## Credit

The North Star Credit Department is charged with the following responsibilities:

Comprehensive credit evaluation and determination of credit terms for contracted direct Dealers.

Insure timely collection of invoices and adherence to credit limits by contracted direct Dealers.

Implement the internal systems to generate invoices, record payments and credits, issue monthly statements, generate Aged Accounts Receivable Reports and Dealer Payment Histories.

Work out credit issues with individual Dealers.

### Terms of Payment

The Credit Department has established the following available terms of payment:

**Payment Terms of up to 30 days (Net)** within previously established credit limits. This is the normal case assuming Dealer establishes and maintains satisfactory credit position.

**Cash in Advance (CIA):** Payment is made and received by North Star Computers for product prior to release of shipment to Dealer.

**Cash on Delivery (COD):** Payment is made by Dealer to freight forwarder upon delivery of product.

**Letter of Credit (LOC):** Payment is made from bank to bank at shipment of product to Dealer. Amount specified on Letter of Credit must be on deposit at time of establishment of Letter of Credit with bank. Terms and conditions of Letter of Credit are determined by communication between North Star and Dealer.

**Sight Draft:** Payment is made from bank to bank prior to release of product to Dealer. Dealer is notified by bank that product will be released upon immediate physical acknowledgment and payment of draft.

**Time Draft:** Same as Sight Draft above with exception of time allowed to pay per number of days stipulated on draft.



**NORTH STAR COMPUTERS, INC.  
AUTHORIZED DEALER AGREEMENT  
WITH**

\_\_\_\_\_  
\_\_\_\_\_  
\_\_\_\_\_

This Authorized Dealer Agreement is entered into as of \_\_\_\_\_, 19\_\_\_\_, by and between North Star Computers, Inc. ("North Star") and the above referenced party ("Dealer") for the purpose of extending to Dealer the benefits of North Star's Authorized Dealer Programs.

**1. Dealer Appointment** North Star hereby appoints Dealer as an Authorized North Star Dealer on the terms and conditions hereinafter described.

**2. Dealer Duties** Dealer agrees to use its best efforts to promote sales of North Star Products purchased from North Star's Distributor to the satisfaction of North Star. Among such other actions as may be necessary to generate sales, Dealer will (a) maintain one or more sales offices identified as sales offices of an Authorized North Star Dealer by exterior signs of good and prominent appearance, (b) at all times have on display and in good operating order for demonstration purposes at each such sales office at least one North Star microcomputer system, and (c) participate in North Star's sales and customer support programs.

**3. Promotional Package** Upon execution of this Agreement and completion of the attached Dealer Information Form, North Star will deliver to Dealer its current Authorized Dealer promotional package containing an Authorized Dealer Manual, a decal identifying Dealer as an Authorized North Star Dealer, displays and miscellaneous sales materials. North Star agrees to update this package on a regular basis with marketing newsletters and additional sales promotion materials as they become available. Dealer agrees to display the decal prominently at its place of business and to use the displays and other materials to the fullest extent feasible in promoting the sale of North Star's Products.

**4. Cooperative Advertising Program** North Star will notify Dealer of any cooperative advertising programs implemented by North Star for its Authorized Dealers and will permit Dealer to participate in said programs on the same basis as other Authorized North Star Dealers.

**5. Advertising** North Star agrees to identify Dealer as an Authorized North Star Dealer in any list of Authorized Dealers or advertising which identifies other Dealers in Dealer's area.

**6. Service Program** Dealer may apply for qualification as an Authorized North Star Service Center and, upon meeting North Star's qualification standards, will be authorized to perform warranty repairs and other service on North Star Products and to receive factory service and spare parts support in accordance with and subject to the terms and conditions of North Star's Servicing Dealer Program.

**7. Limitations** North Star reserves the right to modify at any time the terms of this Agreement or of any program in which Dealer may participate. Nothing in this Agreement shall be construed to authorize Dealer to assume or create any obligation of any kind, express or implied, on behalf of North Star to Dealer's customers or any other person.

**8. Termination** This Agreement may be terminated by either party at any time on thirty (30) days written notice.

In witness whereof, the undersigned have executed this Agreement as of the date first written above.

\_\_\_\_\_  
Dealer Signature (Date)

\_\_\_\_\_  
Dealer Name and Title (Print)

\_\_\_\_\_  
North Star Signature (Date)

\_\_\_\_\_  
North Star Name and Title (Print)

\_\_\_\_\_  
North Star Authorized Distributor Endorsement (Date)

NORTH STAR COMPUTERS, INC  
CUSTOMER APPLICATION

Date\_\_\_\_\_

Company Name\_\_\_\_\_Year Started\_\_\_\_\_

Street Address\_\_\_\_\_

City\_\_\_\_\_Province/State\_\_\_\_\_

Postal Code\_\_\_\_\_Telephone/Telex\_\_\_\_\_

Key personnel and titles:

Name:\_\_\_\_\_Title:\_\_\_\_\_

Name:\_\_\_\_\_Title:\_\_\_\_\_

Resale or I.D. Number\_\_\_\_\_

Dealer[ ] Distributor[ ] Systems House[ ] OEM[ ] International[ ]  
Corporation[ ] Partnership[ ] Proprietorship[ ] Other\_\_\_\_\_

Sales - Latest fiscal year\_\_\_\_\_Ending Date\_\_\_\_\_

If new corporation, plans to finance enterprise:\_\_\_\_\_

Staff:                      Number Full time/ Number Part time/ Years Experience

Management\_\_\_\_\_ / \_\_\_\_\_ / \_\_\_\_\_

Inside Sales\_\_\_\_\_ / \_\_\_\_\_ / \_\_\_\_\_

Outside Sales\_\_\_\_\_ / \_\_\_\_\_ / \_\_\_\_\_

Technical - hardware\_\_\_\_\_ / \_\_\_\_\_ / \_\_\_\_\_

Technical - software\_\_\_\_\_ / \_\_\_\_\_ / \_\_\_\_\_

Clerical\_\_\_\_\_ / \_\_\_\_\_ / \_\_\_\_\_

Location(Kind, Area Type & Number): Retail Store[ ] Office bldg.[ ]

Commercial[ ] Industrial[ ] Urban[ ] Suburban[ ] Rural[ ]

Size of facility (sq.ft.of floor plan)\_\_\_\_\_

Marketing Strategy:\_\_\_\_\_



NORTH STAR COMPUTERS, INC.

NORTH AMERICAN DEALER PURCHASE AGREEMENT

WITH

\_\_\_\_\_  
Buyer

\_\_\_\_\_  
Address

\_\_\_\_\_  
City Province/State Country & Postal Code

This Agreement is entered into as of \_\_\_\_\_,  
19\_\_ , between Buyer and North Star Computers, Inc. ("North  
Star") for the purchase of North Star's Products in accord-  
ance with the terms and conditions set forth below.

1. DEFINITIONS. For purposes of this Agreement:

1.01 Products. "Products" are North Star's  
Horizon microcomputer system and related options and  
accessories described in Schedule A and any other North Star  
products made available to Buyer by written notice from  
North Star during the term of this Agreement.

1.02 Territory. The "Territory" is \_\_\_\_\_

1.03 Delivery Period. The "Delivery Period" is  
the period of twelve (12) months commencing on the first day  
of \_\_\_\_\_, 19\_\_ .

1.04 Estimated Unit Quantity. The "Estimated Unit  
Quantity" shall be a number derived from the number of  
Horizon microcomputers (worth one unit each) and Horizon  
hard disk drives (worth one unit each) agreed upon by the  
parties as a realistic estimate of the number of such  
Products which Buyer will in fact purchase from North Star  
during the Delivery Period. The "Estimated Unit Quantity,"  
together with an estimated delivery schedule, is set forth  
on Schedule B.

2. NORTH STAR DEALERSHIP.

2.01 Dealer Appointment. North Star hereby  
appoints Buyer a North Star Dealer and grants to Buyer the  
non-exclusive right to sell the Products in the Territory  
during the term of this Agreement.

2-23-81

# 5 North Star Policies and Procedures

---

## Whom To Contact For Information

North Star Computers, Inc.: (415) 357-8500

---

### Order Information

Price information, delivery quote, ordering procedures, returns for credit, & checking repair status:

*Regional Sales Administrator*

9am-5pm Pacific Time

8am-4pm Pacific Time for Eastern Region Administrator

---

### Advertising

Co-op advertising information, advertising materials, trademark guidelines, questions regarding leads, trade show support, & sales literature:

*Marketing Communications Department*

---

### Seminar Information

Seminar registration for Application Software, System Software, Hardware and Hard Disk System :

*Product Marketing Department—Seminar Registrar or Coordinator Dealer Sales*

---

### Product Assistance

Contract inquiries & product information:

*Local Direct Sales Administrator*

*Coordinator Dealer Sales*

*National or International Sales Manager*

---

### Dealer Sales Support

*Coordinator Dealer Sales or Local Direct Sales Administrator*

---

### Technical Assistance Hardware or System Software

Maintenance questions, system interface assistance, Quality Control Reports & System Software questions:

*Technical Hotline*

*(415) 357-6990*

or

*Proxima—Computerized Bulletin Board*

*(415) 357-1130*

*10am-4pm Pacific Time*

*24 Hours*

---

### Application Software Technical Assistance

*Application Software Hotline*

*(415) 357-4356*

*10am-4pm Pacific Time*

*Proxima—Computerized Bulletin Board*

*(415) 357-1130*

*24 Hours*

---

### Accounting

Credit memos, debit memos & payment discrepancies:

*Accounts Receivable Clerk or Credit Manager*

---

# 5 North Star Policies and Procedures

---

## Direct Dealer Ordering Procedures

If you have entered into the Direct Dealer Purchase Agreement, and are purchasing product directly from North Star Computers, Inc., there are specific policies and procedures that you should clearly understand and follow to assure a smooth operational relationship with North Star.

The process of entering into Dealer Purchase Agreement will establish the normal case of:

1. Discount Level
2. Shipping Instructions
3. Ship-to/Bill-to Locations
4. Six Month Order Forecast
5. Credit Limit and Payment Terms
6. An Assigned North Star Sales Administrator
7. North Star Dealer Number

**To place an order with North Star Computers, Inc.:**

1. **Mail** a written Purchase Order to:

Your Sales Administrator  
North Star Computers, Inc.  
1444 Catalina Street  
San Leandro, CA 94577

**Alternatives:**

- TWX #(910) 366-7001  
Addressed to your Sales Administrator.
  - Telex #(910) 366-7001
2. Written Purchase Order **must contain** as a minimum:
    - (A) Part Number, Quantity, Description
    - (B) Price (net)
    - (C) Requested Delivery Date
  3. **Optional specifications** for a specific order:
    - (A) Alternate Ship To
    - (B) Special Shipping Instructions<sup>1</sup>
    - (C) "RUSH"

---

<sup>1</sup> Note: Drop Shipment to end customer is prohibited by contract.



# 5 North Star Policies and Procedures

---

## Direct Dealer Ordering Procedures

You will receive an Order Acknowledgment (copy included below) reflecting the contents of your original order. Please check that this Acknowledgment accurately reflects your order and any special instructions. If there is a discrepancy, immediately call your assigned Sales Administrator.

To expedite or validate the scheduled Ship Date as shown on the Order Acknowledgment, call your Sales Administrator.

### Additional North Star Purchase Order Policies

1. Minimum single order net value is \$200.00 for catalog items, small parts single order net minimum value is \$750.00.
2. North Star reserves the right to ship orders up to ten days prior to scheduled ship date unless specifically otherwise instructed in writing.
3. North Star will make every effort to ship orders on or before the scheduled ship date. If for any reason such timely shipment cannot be accomplished, your assigned Sales Administrator will notify you (by phone or by mail/TWX/Telex) as soon as a delay of more than one week is known.
4. All orders are subject to the Terms and Conditions of Sale printed on the back of your Order Acknowledgment. (A copy is included in this section.)
5. All requests for delayed shipment must be submitted in writing to your Sales Administrator. Penalty charges, if any, will be assessed in accordance with your Dealer Purchase Agreement.
6. Products returned without previous Returned Material Authorization (RMA) will be refused at our dock and will be returned to the Dealer **at the Dealer's expense**. Procedures for requesting and obtaining an RMA for specific allowable reasons are explained in Section 7.

# 5 North Star Policies and Procedures

---

## Credit

The North Star Credit Department is charged with the following responsibilities:

Comprehensive credit evaluation and determination of credit terms for contracted direct Dealers.

Insure timely collection of invoices and adherence to credit limits by contracted direct Dealers.

Implement the internal systems to generate invoices, record payments and credits, issue monthly statements, generate Aged Accounts Receivable Reports and Dealer Payment Histories.

Work out credit issues with individual Dealers.

### Terms of Payment

The Credit Department has established the following available terms of payment:

**Payment Terms of up to 30 days (Net)** within previously established credit limits. This is the normal case assuming Dealer establishes and maintains satisfactory credit position.

**Cash in Advance (CIA):** Payment is made and received by North Star Computers for product prior to release of shipment to Dealer.

**Cash on Delivery (COD):** Payment is made by Dealer to freight forwarder upon delivery of product.

**Letter of Credit (LOC):** Payment is made from bank to bank at shipment of product to Dealer. Amount specified on Letter of Credit must be on deposit at time of establishment of Letter of Credit with bank. Terms and conditions of Letter of Credit are determined by communication between North Star and Dealer.

**Sight Draft:** Payment is made from bank to bank prior to release of product to Dealer. Dealer is notified by bank that product will be released upon immediate physical acknowledgment and payment of draft.

**Time Draft:** Same as Sight Draft above with exception of time allowed to pay per number of days stipulated on draft.

# 5 North Star Policies and Procedures

---

## Credit

### Criteria For Credit Establishment

Terms of payment and credit limits are established as a result of evaluation of the following criteria:

- A. Financial Strength—sources include:
  - 1. Financial Statement (Preferably audited) provided by Dealer.
  - 2. Dun and Bradstreet Report.
  - 3. Department of Commerce Report (International).
- B. Credit History—sources include:
  - 1. References provided by Dealer which must include one (1) bank and three (3) major suppliers.
  - 2. Dun and Bradstreet Report.
  - 3. Department of Commerce Report (International).
  - 4. Credit history established with North Star.
- C. Anticipated Purchases—as reflected by three (3) month schedule order placed by Dealer and accepted by North Star.
- D. Payment terms and credit limits requested by Dealer.
- E. Specific economic and market conditions.

### Procedures For Establishing Terms of Payment and Credit Limits.

Terms of payment granted Dealers, pending credit approval, may be up to fifteen (15) days after date of invoice within the continental United States and up to thirty (30) days after date of invoice outside the continental United States.

A request for credit terms or a change in terms of payment and/or credit limit must include the following information:

- 1. A current Financial Statement (Preferably audited).
- 2. A list of credit references: one (1) bank and three (3) major suppliers.

Results of evaluation of a request for credit terms or a change in terms of payment and/or credit limit will be mailed by the Credit Department.

# 5 North Star Policies and Procedures

---

## **Credit**

### **Statement of Account**

A Statement of Account will be mailed to Dealers at the end of each month. The statement will be a valuable tool to maintain your account with North Star on a current basis. Further, your immediate response to any "discrepancies" between your records and ours will promote immediate resolution of such and insure continuation of a compatible and profitable business relationship. Such resolution should be cleared up by phoning or writing the appropriate Supervisor of Credit Accounts.



# 6 North Star Marketing Support

---

## Introduction

North Star Computers, Inc. provides you, the Authorized Dealer, with many Marketing Support Programs. These range from **Corporate Programs** that increase Small Business Community awareness of North Star as a quality systems supplier through a number of **Dealer Programs** that are provided to help you promote sales of North Star products profitably.

The objectives of the Corporate Programs are to build awareness and interest in North Star and its products and to lead this interest to you. These objectives will be realized by:

1. A continuous aggressive Worldwide Advertising and Public Relations Campaign.
2. Participation in a wide variety of large national and international Trade Shows.

The objectives of the Dealer Programs are to provide you with essential product information, training, sales tools, and a steady flow of leads.

These objectives will be realized by:

1. Dealer News
2. Dealer Training Seminars (Hardware/Software)
3. Dealer Manual
4. Product Literature and Point of Sales Materials
5. Sales Leads
6. Direct Sales Support
7. Cooperative Advertising Program

# 6 North Star Marketing Support

---

## Introduction

This section gives you detailed information on what programs are provided, how they benefit your business and how to take advantage of them. It is organized as outlined below:

### **Corporate Programs**

- Worldwide Advertising Campaign
  - Small Business
  - Trade/Industry
- Public Relations
- Trade Shows

### **Dealer Programs**

- Dealer News
- Training Seminar
  - Hard Disk
  - Hardware
  - System Software
  - Application Software
- Dealer Manual
- Literature and Point of Sales Material
- Sales Leads and Follow Through
- Direct Sales Support
- Co-op Program
  - Policy
  - Procedures
  - Guidelines
  - Ad Slicks and Materials

# 6 North Star Marketing Support

---

## Corporate Programs

### North Star Worldwide Advertising Campaign

Our new Worldwide Corporate Advertising Campaign is designed to generate increased awareness of North Star and generate sales leads for you, the Dealer.

Our advertising program is currently targeted to two major areas:

1. The Small Business Market (for end user pull through)
2. Authorized Dealers/Distributors (to expand Dealer/Distributor Network)

Through our advertising, we introduce prospective Small Business Market customers to our company and our products. We give them an overview about our benefits: performance, reliability, cost effectiveness, problem solving capabilities and system expandability. And, we ask them to visit their local Authorized North Star Dealer for further information and demonstration.

We generate potential sales for our Dealers by toll free numbers, coupons, and magazine response inquiry cards—"bingo cards". These sales leads are turned over to the nearest Dealer for follow-up.

The first part of our new advertising campaign began with advertisements which addressed the Small Business System Marketplace through schedules in *INC.* Magazine, American Airlines *American Way* and United *Mainliner* magazines.

The campaign started with a full color two page center spread in the April 1981 issue of *INC.* and was followed by full color pages in all three publications in May.

We use toll free phone numbers in these new ads for potential buyers to call in for referral to their nearest Authorized North Star Dealer. Please always keep us aware of your current address and phone number, as inquiries will automatically be referred to the nearest Authorized Dealer's location.

We chose two airline magazines, *American Way* and United's *Mainliner* because of their enormous audience reach. Each has in excess of *one million* readers per copy per month. American carries the highest percentage of business travelers, while United carries a great number of transcontinental passengers, as well as passengers making connecting flights. Combined, they also carry the greatest number of international business passengers traveling within the United States. They give us a greater degree of exposure to create awareness of North Star products and to generate end user demand for those products.

You will automatically be provided with ad reprints, follow-up brochures, counter cards and other Point of Sale materials linked to our Advertising Campaign. (See Dealer Programs within this section for more details on these items.)

# 6 North Star Marketing Support

---

## Corporate Programs

### **Public Relations**

North Star's internal Public Relation efforts are directed at keeping our company name in the general marketplace by using press releases of new products, programs, and personnel and by providing news stories and case histories on how and by whom our products are used.

This publicity reinforces the image of our advertising, helps potential customers remember our name, and positions us as a professional company offering high quality products with tangible benefits to the end user.

The more often potential customers see and hear our name, the more likely they will consider North Star when buying computer products.

Press Releases bring reader inquiries, which we in turn pass on to Dealers as potential customers.

### **Trade Show Participation**

Throughout the year North Star exhibits at major trade shows in both the domestic and international marketplaces. Again, our purpose is to increase and reinforce awareness of North Star's products and generate potential customers for our Dealers.

We continuously evaluate each show for its effectiveness and adjust the next year's schedule accordingly. We provide current schedules in every issue of our Dealer News.

We also encourage Distributor and Dealer participation in regional, local and vertical market shows.

### **NORTH STAR COMPUTERS, INC. 1982 TRADE SHOW SCHEDULE**

1. Beijing/U.S. Dept. of Commerce Light Industry Show—  
Feb. 5-15, 1982, Beijing, PRC.
2. NCC Office Automation Conf. — April 5-7, 1982,  
San Francisco, CA.
3. Hanover Fair — April 21-28, 1982, Hanover, W. Germany.
4. NCC '82 — June 7-10, Houston, TX, Booth 7523
5. COMDEX/Spring '82 — June 28-30, 1982, Atlantic City, N.J.,  
Booth 228
6. INFO '82 — October 11-14, 1982, New York, Booth 1438
7. COMDEX '82 — November 29 — December 2, 1982, Las Vegas  
Convention Center, Booth 2031

# 6 North Star Marketing Support

## Dealer Programs

### Dealer News

It is North Star's policy to announce any new products, pricing, new key personnel and Dealer Programs or Policies to our Dealers before any information is made public. North Star's *Dealer News*, published monthly, is the primary means of providing such announcements to you. It is very important for you to read each issue and pass along the information to your staff.

It is suggested that you accumulate back issues of the Dealer News within this manual at the end of this section for handy reference.

  
**DealerNews**

Vol. 5, No. 3April 1982

### Enhanced MicroPlan™ and WordStar™ Offered To Dealers

Two powerful and well known CP/M® software packages, MicroPlan™ and WordStar™, have now been enhanced by North Star to give users the edge. And to give you an edge in selling the products, North Star announces that for a limited time only, each Authorized Dealer may buy one copy of Enhanced WordStar and/or Enhanced MicroPlan for only \$99 each. This special offer, which expires June 1, 1982, is extended to our Dealers to encourage you to demonstrate the valuable enhancements we offer the user in North Star Enhanced MicroPlan and WordStar. (See the enclosed order form for further details.)

*continued on page 3*

### North Star Readies for NCC

North Star is gearing up for the National Computer Conference in Houston, Texas, June 7-10, according to Ted E. Buxton, trade show coordinator.

The new booth, which made its debut at the Office Automation Conference earlier this month, will expand to cover 1,600 square feet, and will include 23 separate product demonstrations using North Star hardware and software.

The Office Automation Conference, held April 5-7 in San Francisco, attracted nearly 19,000 prospects who came to view new

*continued on page 5*



### Dealers Call Directly To Hotline

As mentioned in last month's Dealer News, Technical Services is moving to North Star's additional facility adjacent to the headquarter building.

Because of this move, the corporate switchboard will no longer be able to transfer calls from North Star's main number to the Hotline extension. Therefore effective May 3, 1982, the Hotline can only be reached by calling the numbers published in the Dealer Manual.

North Star Enhanced MicroPlan™ includes improved documentation

# 6 North Star Marketing Support

---

## Dealer Programs

### Dealer Training Seminars

North Star provides Dealer Training Seminars covering the following areas:

#### Seminar

Sales and Marketing Strategies  
Application Software  
Operating Systems Software  
HORIZON® Orientation  
North Star ADVANTAGE Orientation  
Hardware Maintenance

### Registration Information

To enroll in any of the seminars listed, contact the North Star Training Registrar at (415) 357-8500. We urge you to register well in advance as most North Star seminars fill prior to seminar date. All seminar registration is finalized two weeks prior to the week the seminars are scheduled.

Seminar Schedule and Registration information is published in the *Dealer News* and through regular mailings from the Product Training Department.

After receipt of your training request, the training center will provide a written confirmation of your registration along with local hotel information and directions to the training seminars.

North Star reserves the right to cancel any seminar due to insufficient enrollment. If this occurs, all enrollees will be notified as soon as possible, which will be no later than one week prior to the seminar date.

Training Seminars will be available at any authorized Distributor or Dealer location. If you are interested in having an on-site seminar, please contact the Training Registrar for further information.

# 6 North Star Marketing Support

---

## Dealer Programs

### SEMINAR DESCRIPTIONS

**Sales and Marketing Strategies:** This three day course will provide information on developing sales and marketing strategies for selling business computer systems. An overview of computer systems, competitive analyses, selling techniques, market segmentation and analysis, are some of the areas covered in the course instruction. Role playing and class discussion of selling techniques are also included.

**Application Software:** This four day course is intended for those desiring a thorough exposure to North Star Application Software and the TSS/A timesharing system. Detailed functional descriptions, demonstrations, practical hands-on exercises, system set up and installation procedures are all a part of the course instruction.

**System Software:** This two day course describes the design and operation of North Star DOS, CP/M, and ASP (Application Support Package). The course covers the command and file structure of North Star DOS, HDOS and CP/M; and overview of operating and peripheral support system structures and the techniques for personalization. The course will also cover the TSS/C timesharing systems. It is designed for applications programmers and technicians involved with the installation and maintenance of North Star systems.

**North Star ADVANTAGE Orientation:** A three day course giving an overview of the North Star ADVANTAGE computer. It will cover the hardware at a block-diagram level, system software and the graphics capabilities. The Floppy Disk and 5Mb Hard Disk drives are explained with a hands-on demonstration of disk drive alignment. Emphasis is placed on trouble-shooting and diagnostic techniques with time allotted for hands-on exercises. A good knowledge of digital electronics and North Star DOS is recommended.

**HORIZON® Orientation:** This three day course covers all the hardware of the HORIZON computer system at a block-diagram level. It is oriented towards the non-technical dealer who needs to know how to install, configure and trouble-shoot the system. Subjects covered include all the HORIZON subassemblies, the HD18 Hard Disk Drive and the Tape Backup System, with an explanation of disk formatting and checkout procedures. Both 5¼" hard and floppy disks are covered during the North Star ADVANTAGE Orientation class. Time has been scheduled for hands-on exercises during the course. Some knowledge of digital logic is recommended.

**HORIZON and North Star ADVANTAGE Maintenance:** A four day course for experienced technicians, it covers all of North Star's products at the component level. Emphasis is placed on diagnosis and repair techniques with extensive time for hands-on exercises. All the HORIZON and North Star ADVANTAGE subassemblies are covered as well as the hard and floppy disk drives and the Tape Backup System. Prior attendance at the Hardware Orientation courses is recommended. Priority is given to authorized service centers with space available to any dealer meeting prerequisite.

# No business is too small for a NORTH STAR



## The economical business computer that does it all.

Bookkeeping. Mailing Lists. Word processing. Running your business is a lot more complex than running a lemonade stand. But it doesn't have to be. Sure, you may already know you could use a computer. But did you know that the North Star HORIZON® can do the job better than many bigger computers? For much less money?

The North Star HORIZON is easy to install and operate. As you grow, add programs, work stations, and memory. Today, more than 22,000 HORIZONS are in operation worldwide.

HORIZON is a registered trademark of North Star Computers, Inc.

And our sales and service support is there to help you.

So look at the HORIZON before you buy a computer. You owe it to yourself. And to your business.

For the dealer in your area, call toll-free (800) 447-4700.

In Illinois (800) 322-4400.

In Alaska and Hawaii (800) 447-0890. Or write

North Star Computers, Inc.,  
14440 Catalina Street,  
San Leandro, CA 94577.

Phone (415) 357-8500.  
TWX/Telex (910) 366-7001.

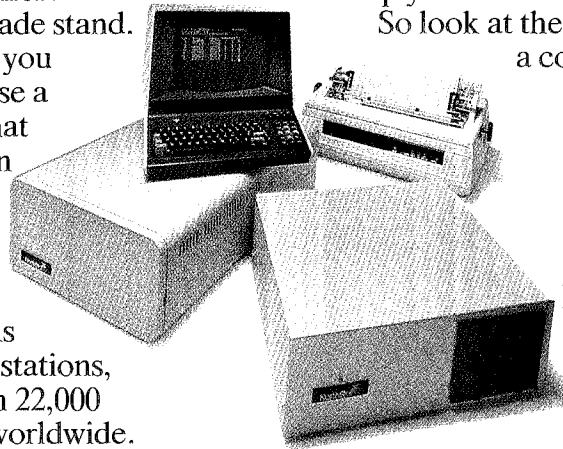

FOLLOW THE STAR

**NorthStar**™



# Businesses worldwide can depend on NORTH STAR

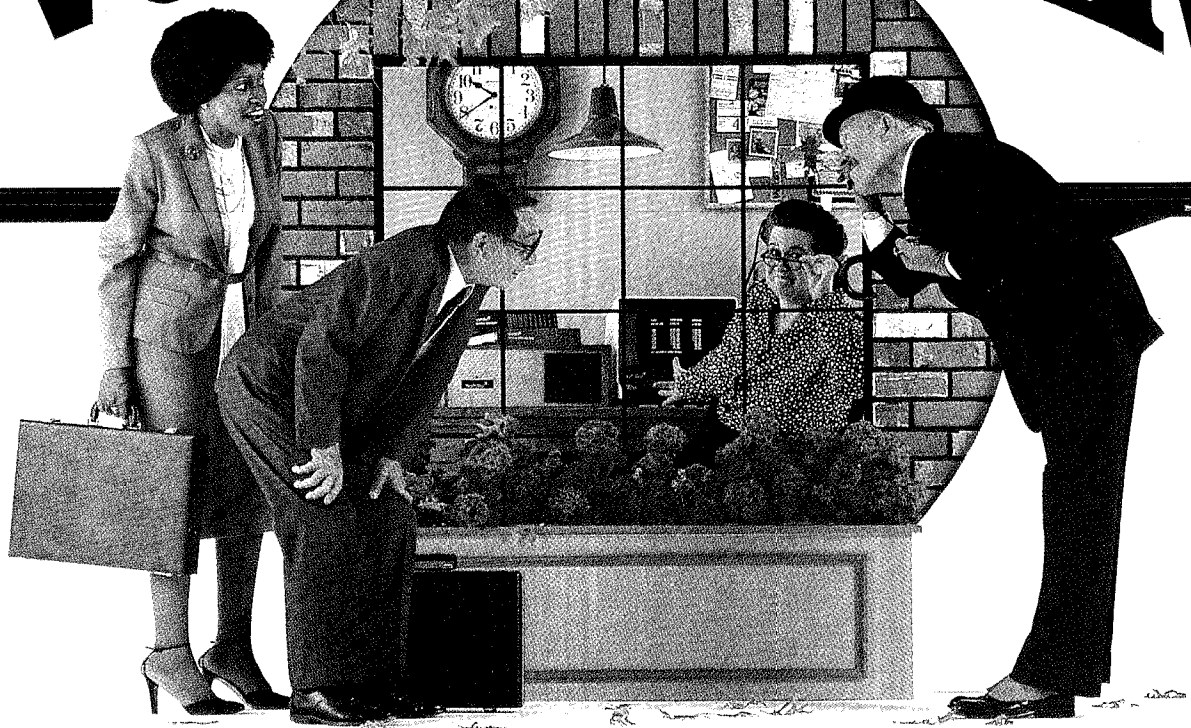

## All Dealers need to know about the business of selling computers is North Star.

Let's face it, there's really only one thing you need to know about the kind of computer you sell. That you can sell it with pride, knowing that your customer is going to be happy.

That's what the North Star HORIZON<sup>®</sup> is all about. With its reliability, flexibility, simplicity, and speed, your customers will have lots of reasons for liking the HORIZON. And you'll have two *big ones*. Peace of mind and profit. It's an easy system to sell and it's an easy system to take care of. We offer a complete line of systems and application software. On top of that, we also have technical support and a Dealer Hotline to help you solve any unforeseen difficulties.

All in all, you'll find the North Star HORIZON works

very hard to make your business a success.

For more dealer information on the family of HORIZON hardware and software systems, call (415) 357-8500.

North Star Computers, Inc.,  
14440 Catalina Street,  
San Leandro, CA. 94577 USA  
(415) 357-8500 TWX/Telex  
(910) 366-7001

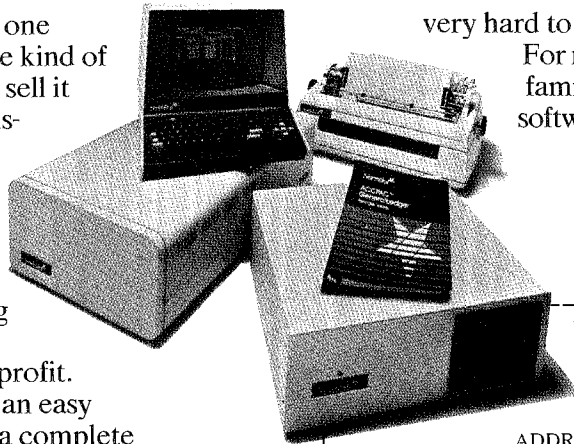

Yes, I'd like more dealer information.

NAME \_\_\_\_\_

COMPANY \_\_\_\_\_

ADDRESS \_\_\_\_\_

CITY \_\_\_\_\_

STATE \_\_\_\_\_ ZIP \_\_\_\_\_

PHONE ( ) \_\_\_\_\_

The North Star logo and HORIZON are trademarks or registered trademarks of North Star Computers, Inc.

©1981, North Star Computers, Inc.

FOLLOW THE STAR  
**NorthStar**™

# 6 North Star Marketing Support

---

## Corporate Programs

### Public Relations

North Star's internal Public Relation efforts are directed at keeping our company name in the general marketplace by using press releases of new products, programs, and personnel and by providing news stories and case histories on how and by whom our products are used.

This publicity reinforces the image of our advertising, helps potential customers remember our name, and positions us as a professional company offering high quality products with tangible benefits to the end user.

The more often potential customers see and hear our name, the more likely they will consider North Star when buying computer products.

Press Releases bring reader inquiries, which we in turn pass on to Dealers as potential customers.

### Trade Show Participation

Throughout the year North Star exhibits at major trade shows in both the domestic and international marketplaces. Again, our purpose is to increase and reinforce awareness of North Star's products and generate potential customers for our Dealers.

We continuously evaluate each show for its effectiveness and adjust the next year's schedule accordingly. We provide current schedules in every issue of our Dealer News.

We also encourage Distributor and Dealer participation in regional, local and vertical market shows.

### **North Star Computers, Inc. 1981 Trade Show Schedule**

- NCC Office Automation Conference — March 23-25, Houston, TX.
- Interface '81 — March 30-April 2, Las Vegas, NV.
- National Computer Conference — May 4-7, Chicago, IL.
- Office Korea '81 — March 26-29, Seoul, Korea.
- Comdex/Spring '81 — June 23-25, New York, NY.
- NOMDA — July 23-25, Las Vegas, NV.
- INFO '81 — October 12-15, New York, NY.
- Systems '81 — October 19-23, Munich, W. Germany.
- Comdex '81 — November 19-22, Las Vegas, NV.

# 6 North Star Marketing Support

---

## Dealer Programs

### Dealer News

It is North Star's policy to announce any new products, pricing, new key personnel and Dealer Programs or Policies to our Dealers before any information is made public. North Star's *Dealer News*, published monthly, is the primary means of providing such announcements to you. It is very important for you to read each issue and pass along the information to your staff.

It is suggested that you accumulate back issues of the Dealer News within this manual at the end of this section for handy reference.



## Dealer News

VOLUME 4  
NUMBER 4  
APRIL, 1981

---

### New Application Software Products

As part of our on-going plan to provide a complete range of application software for the small business market, North Star is pleased to announce two additions to the ACCPAC™ line:

#### OrderEntry and Invoicing

North Star's OrderEntry and Invoicing package is a complete system for handling the processing of sales orders and invoices. This system is available in double or quad-density Floppy Disk Versions, and a Single or Multi-User Hard Disk Version, available for shipment beginning in August, 1981. Your North Star Sales Administrator or Authorized Distributor can accept orders immediately. Part numbers and Suggested Retail Prices are:

OrderEntry-D	00176	\$ 999
OrderEntry-Q	00491	999
OrderEntry-HD*	00180	1099
OrderEntry DOC	00492	75

\*Compatible with North Star's TSS/A Multi-User System.

Principal features of the OrderEntry and Invoicing package are:

- Order processing—add, recall, change or cancel sales orders; print order confirmations or packing slips; add, modify or cancel standing orders.
- Invoice processing—recall orders for invoicing; print invoices or an invoice journal.
- Credit processing—enter returns or credit memos; print credit memos or a credit memo journal.
- Ship-to maintenance—add, modify or delete ship-to addresses.
- Inquiries—handle customer account or inventory item inquiries.
- Print reports and tables.

OrderEntry and Invoicing also gives the user flexibility in defining accounts, in setting tax schedules, and five-level pricing schedules by customer

type, and in report formats. This package also interfaces with InventoryControl and Analysis, and with the ACCPAC accounting packages.



### InventoryControl and Analysis

North Star's InventoryControl and Analysis package is a complete system for tracking quantity, pricing and costing data of inventory items. This system is available in double or quad-density Floppy Disk Versions, and a Single or Multi-User Hard Disk Version, available for shipment beginning in June, 1981. Your North Star Sales Administrator or Authorized Distributor can accept orders immediately. Part numbers and Suggested Retail Prices are:

Inventory-D	00168	\$ 999
Inventory-Q	00426	999
Inventory-HD*	00172	1099
Inventory DOC	00425	75

\*Compatible with North Star's TSS/A Multi-User System.

Principal features of the InventoryControl and Analysis package are:

- Flexible variable item or part number format up to a maximum of 16 characters and 4 segments.
- Option to use inventory categories or departments, as well as distribute information on cost of sales to the ACCPAC GeneralLedger.

Continued on page 2

North Star Computers, Inc. 14440 Catalina St. San Leandro, CA 94577 (415) 357-8500 TWX/Telex (910) 366-7001

# 6 North Star Marketing Support

---

## Dealer Programs

### Dealer Training Seminars

North Star provides Dealer Training Seminars covering the following areas:

Seminar	Seminar Number
1. Application Software	1
2. System Software	2
3. Hard Disk Servicing	3
4. Hardware Servicing	4

### Registration Information

To enroll in any of the seminars listed, contact the North Star Training Registrar at (415) 357-8500. We urge you to register well in advance as most North Star seminars fill prior to seminar date. We also suggest you provide an alternate seminar date to assure that we can accommodate you. All seminar registration is finalized two weeks prior to the week the seminars are scheduled.

After receipt of your training request, the training center will provide a written confirmation of your registration along with local hotel information and directions to the training seminars.

North Star reserves the right to cancel any seminar due to insufficient enrollment. If this occurs, all enrollees will be notified as soon as possible, which will be no later than one week prior to the seminar date.

Training Seminars will be available at any authorized Distributor or Dealer location. If you are interested in having an on-site seminar, please contact the Training Registrar for further information.

# 6 North Star Marketing Support

---

## Dealer Programs

### SEMINAR DESCRIPTIONS

**System Software** This two day seminar describes the design and operation of North Star DOS/BASIC, CP/M, and PASCAL. The course teaches the command and file structure of North Star DOS and CP/M; overview of coding, editing, compilation and debugging of program languages and the techniques for personalizing. The course will also cover the TSS/B timesharing system.

**Application Software** This is a three day entry level course intended for managers non-programmers desiring a thorough exposure to North Star Application Software and timesharing system. The course includes detailed functional descriptions, demonstrations, and practical hands-on exercises. The student who completes this course will acquire the knowledge to sell and support application software products on single and multi-user systems.

**Hardware Servicing** This three-day class provides in-depth technical instruction on the theory of operation and checkout procedures for the following subassemblies: ZPB-Z80 processor, 16RAM, 32RAM, HRAM, HSIO4 boards, Disk Controller board, and HORIZON motherboard. The seminar also includes practical hands-on exercises in drive alignment procedures. Attendees should have a basic understanding of digital logic.

**Hard Disk** The content of this one day seminar includes software sessions covering the first time use of HD-18, using HDTest, total recovery program, HDOS commands, and back up and recovery procedures. Hardware discussion includes the logical dimensions of the Hard Disk, theory of operation, assembly and disassembly. Participants should have a basic understanding of digital logic.

# 6 North Star Marketing Support

---

## Dealer Programs

### Dealer Manual

This Dealer Manual is provided as a reference to all aspects of working with North Star. Whether you are purchasing from North Star directly or through an Authorized Distributor this Manual should serve to answer your questions regarding:

Who is North Star? Where are they going?

What is North Star's primary market focus?

What products does North Star offer?

What are their primary benefits or features?

How are the products expanded and integrated?

Detailed product descriptions.

How do you do business with North Star?

What specific Marketing Programs are provided?

What specific Technical Supports Programs are provided?

What Field Service Policies are offered?

How do you use them?

As you can see, each page of this Manual is section and date coded as well as numbered. This is to facilitate easy replacement or insertion of update pages as they are provided. North Star's policy will be to use the Dealer News for providing preliminary announcement information, relatively volatile schedule information (Trade Shows, Seminar Schedules, etc.) and monthly "news" items and this Manual for more permanent reference material describing current products, pricing, policies and support programs.

# 6 North Star Marketing Support

---

## Dealer Programs

### Literature and Point of Sale Material

In conjunction with our new Advertising Campaign, North Star is developing follow-up literature and Point of Sale material. These materials are thematically and graphically tied to the Advertising Campaign to promote a uniform North Star image and message. Examples of this literature follow this page.

1. **Ad Response Brochure:** To be used in response to leads generated by our Advertising Campaign.
2. **Wall Posters:** To be hung on the wall or given to prospect as a reinforcement of the “No business is too small for a North Star” message.
3. **North Star Product Data Sheets:** To be used as customer hand-outs or as part of a proposal for detailed description of North Star products. Examples are included in Section 4.

# 6 North Star Marketing Support

---

## Dealer Programs

### Sales Leads and Follow Through

Advertising, Public Relations and participation in Trade Shows generate sales leads which we distribute as quickly as possible to Authorized Dealers.

The quality of these leads varies from the mildly interested "browser" to the very interested immediate buyer. We are constantly trying to improve both the quantity and quality of sales leads.

Once you have received these leads, you should follow-up on them as quickly as you would on leads generated from your own advertising. With MailManager you can put leads on a permanent mailing list and combine these into personalized follow-up inquiries with NorthWord.

In responding to leads, be sure to invite the potential customer to your site for a demonstration. Use this demonstration time to determine the prospect's requirements and the best way to satisfy them. Sell the benefits of a North Star system. Don't forget to put the prospect on your own mailing list for new product releases and future promotions if the demonstration and subsequent follow-up fails to result in a sale.

From time to time we will be asking you how effective these sales leads are. Through such feedback you can help us make our Advertising, Public Relations and Trade Show Programs more effective for you.



# 6 North Star Marketing Support

---

## Dealer Programs

### Direct Sales Support

North Star Computers, continuously supports its Distributors and Dealers with both direct sales people located in regional areas and with Home Office Sales Coordinators.

In the North American area, field sales people are located in the eastern, central and western regions of the continent. It is their responsibility to provide you with "on site" support. This support includes keeping you apprised of new North Star policies, products and programs; back-up support for special sales situations that may need the "reinforcement" of a North Star employee to help you close that big sale; and finally to handle any serious problems that may result from customer or sales situations. Your Regional Sales Representative is your "front line" team member from North Star.

At the home office level, we provide additional support from the Coordinator of Dealer/Distributor Sales. The responsibility of the Coordinator is to assist you, and our Regional Sales Representatives, with backup support that is not readily handled within other North Star departments. The Coordinator of Dealer/Distributor Sales can help you, for instance, secure answers to certain technical (hardware or software) questions that cannot readily be found in technical documentation or from other sources. The Coordinator can also act on your behalf on matters that relate to other departments within North Star Computers, such as the Credit Department or Order Administration.

# 6 North Star Marketing Support

---

## Dealer Programs

### Cooperative Advertising Program

Whether you purchase directly from North Star or through an Authorized Distributor you qualify for North Star Co-op Advertising Funds as long as you:

1. Have a signed *Authorized Dealer Agreement* on file with North Star.
2. Are in good credit standing (as a Direct Dealer).
3. Comply with the conditions and guidelines on the Co-op Advertising Policy. (A copy of this policy and appropriate forms follows.)

### Dealer Co-op Advertising Policy Summary

The Co-op Advertising Policy provides accruals by calendar quarter of three percent (3%) of an Authorized Dealer's net purchases of North Star approved products. Approved products include HORIZON computers, Hard Disks, memory and other boards, software products, etc. They do not include CRT terminals, printers, general supplies, parts, repair or shipping charges.

After the close of each quarter, we will send out Accrual Statements showing the dollar amount accrued over that quarter. Claims can be made against these funds in the following quarter.

Many types of advertising or promotion are covered under the Co-op Advertising Policy, including newspaper and magazine ads, radio or television spots, catalogs or mailers, etc. Most common types of advertising do not require prior approval from North Star; unusual items do. When in doubt, check beforehand with the Marketing Communications Department.

Co-op Advertising Funds can cover fifty percent (50%) of the cost of your advertising promoting North Star products. If you show products from another manufacturer in the same ad, only that portion of the ad showing North Star products will be considered. For example, if your ad shows only North Star products, 50% of that ad's cost could be covered by Co-op Funds. If only half the ad shows North Star products, then 25% of the cost could be covered. We will, of course, allow reasonable space in any ad for your logo, store address, etc.

Claims will be processed and approved as they are received by the Co-op Advertising Department in Marketing Communications. Once claims are approved, a Credit Memo will be issued to your account. Those who purchase through Authorized Distributors will be issued a special Credit Voucher. Claim forms will be provided.

If your claim is adjusted, or not approved, or if you do not have sufficient funds accrued to cover the claim, you will be notified. Any funds not used during an appropriate quarter will not be carried over to the next quarter.

Advertising Guidelines must be observed in order to qualify for Co-op approval. These Guidelines are generally "common sense" procedures. Your advertising must not be deceiving and should be in compliance with any appropriate state or federal regulations. You cannot make any claims or guarantees that are not those made by North Star. In print advertising, you must show the product and give some description of its features, benefits, etc.

# 6 Cooperative Advertising Program

---

## Dealer Policy

August 1, 1982

North Star Computers, Inc. (North Star) has implemented a Cooperative Advertising Policy to help provide funds for individual Authorized North Star Dealers to place advertising in local markets. The Cooperative Advertising Policy allows you to tie in local advertising with North Star's national advertising campaigns, increase brand name recognition, and generate traffic for your business by identifying you with North Star.

### Accruals

North Star provides an accrual for its Authorized Dealers of three percent (3%) of the net price of your purchases of approved North Star products. Approved North Star products include computers, software products, hard disk units, RAM and other boards, but does not include printers, general or printer supplies, parts, or shipping costs.

Cooperative advertising funds accrue each calendar quarter and are based on the actual net shipments for that quarter. Only distributors and direct dealers receive accrual statements from North Star. Indirect dealers must contact their distributor for information regarding the dollar value of the funds they have accrued. Funds accrued in one quarter must be utilized in the following quarter. For example: if your net shipments during the Jan-Feb-Mar quarter totalled \$100,000, you would accrue \$3000 in cooperative advertising funds to be used during the Apr-May-June quarter. Funds may not be transferred by one Dealer to another, and any unused funds may not be carried into the next quarter. An advice of earned accruals will be sent within 15 days of the end of the quarter in which they were earned.

These cooperative advertising funds may be used for local advertising purposes, including newspaper and magazine space, radio and television time, direct mail pieces, and other promotional means detailed in this Policy. This accrual does not cover advertising agency fees or commissions, postage, salaries, or other intangible advertising expenses.

All claims for cooperative advertising credit must be submitted in accordance with the terms and conditions set forth in this Policy.

North Star cooperative advertising accruals will be applied toward 50% of the cost of the following media providing all requirements are met and the Dealer remains in good standing.

### Qualifications

#### Media:

1. General interest daily, weekly and Sunday newspapers
2. General interest or business magazines
3. Radio spot ads
4. Television spot ads
5. Catalogs or fliers (printing and paper)

Advertisements in which other manufacturers' products appear along with North Star products will be eligible for credit only to the extent of the amount of pro-rated space or time allocated to the North Star products. Reasonable space or time for the Dealer's logo, location, or sign-off will be allowed.

# 6 Cooperative Advertising Program

---

## Dealer Policy

February 1, 1981

Other methods of advertising not specifically covered in this Policy may qualify for cooperative advertising credit, but require prior approval from North Star. This may include trade shows, exhibits and permanent displays, outdoor or mobile transit advertising, special promotions, etc. Please check with your Distributor or with the North Star Marketing Communications Department if you are unsure whether your advertising or promotion qualifies for co-op credit.

### **B. Advertising Requirements**

In order to qualify for cooperative advertising credit, all advertising must comply with the following requirements:

1. The North Star logo must be prominently displayed in all print media. The North Star logo must be reproduced photographically, not artistically.
2. All appropriate trademarks of North Star must be properly designated.
3. Illustrations or photographs of the North Star products advertised must appear in all print media. Listing the products without illustration will not qualify for credit.
4. Advertising must include copy describing performance characteristics or distinctive qualities of the North Star products; merely showing the product and a price will not qualify for credit.
5. Advertising must not be misleading as to terms, product features, etc., nor can they be in violation of any state, federal, or local law. An ad is considered misleading if the Dealer does not have sufficient supply of the product in stock to meet anticipated demand, or if the ad is used for bait and switch purposes. Advertising carrying performance claims or guarantees that are inaccurate or are not warranted by North Star will not be approved for credit.
6. Advertising must be in good taste, be in keeping with a high standard of ethics, and favorably reflect and promote the image of North Star and its products.

North Star, at its sole discretion, may, under this Policy, disqualify or disallow claims for advertising not adhering to the terms and conditions set forth in this Policy.

### **Submitting Claims**

All claims must be submitted in accordance with the terms and conditions set forth in this Policy. Claims should be marked "Cooperative Advertising Program," and should be submitted no later than 30 days after the end of the quarter in which funds were used.

Newspaper, radio, and television advertising claims must be based on net cost of the advertising at the lowest net-earned rate, after deduction of any cash discounts, trade discounts, or other allowances.

# 6 Cooperative Advertising Program

---

## Dealer Policy

February 1, 1981

All claims must be supported by the following documentation:

**A. Claims not requiring prior approval.**

1. Newspaper and magazine ads: A copy or tear-sheet of the page on which the ad appeared, showing publication's name and issue date, along with a copy of the publication's invoice for that ad.
2. Radio ads: A written copy of the radio script with proof of broadcast or station affidavit showing dates, times, and products broadcast, along with a copy of the station's invoice.
3. Television ads: A written copy of the television script with proof of broadcast or station affidavit showing dates, times, and products broadcast, along with a copy of the station's invoice.
4. Catalogs and fliers: A complete copy of the catalog or flier, along with a copy of the printer's invoice.

**B. Claims requiring prior approval.**

Methods of advertising not specifically covered in this Policy may qualify for cooperative advertising credit and are subject to prior approval by North Star. Such methods of advertising may include trade shows, displays, billboards, and other advertising specialties. When submitting a claim for prior approval, provide details of the proposed project, including descriptive copy, sketch or sample, and estimated costs. You will receive notification if the proposed projects meet cooperative advertising requirements.

**Credits**

Credit will be issued by North Star as claims are approved and processed, and such credit may be applied against your future purchases. Advertising claims may not be deducted by Dealers from their outstanding invoices.

Dealers will be notified if any claim is disallowed, or if the funds accrued by the Dealer are not sufficient to meet the claim.

**Amendments and Termination**

North Star reserves the right to amend or terminate this Policy upon 30 days written notice. Such amendment or termination will not affect claims for commitments made prior to the effective date of amendment or termination.

In the event of termination of a Dealership for any reason whatsoever, the entire advertising co-op fund balance of that Dealership will be forfeited to North Star after charging to it all claims accruing prior to the effective date of termination.

# 6 Cooperative Advertising Program

---

## Advertising Guidelines: Trademark Information

August 1, 1982

Advertising and literature mentioning the HORIZON® or other North Star products must carry the proper information regarding the trademarks held by North Star, or by associated companies. The following is a list of names and products affected.



The North Star logo must be reproduced photographically. No drawings or artist's renderings may be used. When using the name of the company, it is North Star Computers, Inc., or North Star. Should you wish to use North Star blue, the proper color is PMS (Pantone Matching System) 288.

### **HARDWARE:**

1. **HORIZON®** Registered trademark of North Star Computers, Inc.
2. **Z-80A®** Registered trademark of Zilog, Inc.

### **SOFTWARE:**

1. **CP/M®** Registered trademark of Digital Research, Inc.
2. **PROPAC™** Trademark of North Star Computers, Inc.
3. **NorthWord™** Trademark of North Star Computers, Inc.
4. **NorthNet™** Trademark of North Star Computers, Inc.
5. **FASTACK™** Trademark of North Star Computers, Inc.
6. **InfoManager II™** Trademark of Basic Software Group, Inc.
7. **ACCPAC™** Trademark of Basic Software Group, Inc.
8. **Enhanced WordStar™** Trademark of MicroPro International Corporation.
9. **SpellStar™** Trademark of MicroPro International Corporation.
10. **MailMerge™** Trademark of MicroPro International Corporation.
11. **Enhanced MicroPlan™** Trademark of Chang Laboratories.
12. **dBASE II™** Trademark of Ashton-Tate.
13. **MSDOS™** Trademark of Microsoft, Inc.

When using these names or products, you should follow their **FIRST** appearance by the appropriate mark and an asterisk, explaining in a footnote the proper information regarding who the registered mark or trademark belongs to.

Please be aware that our manuals, documentation, and other materials are copyrighted. Should you wish to reproduce these materials, you must have our permission.

The name ADVANTAGE must always be preceded by the words North Star (i.e., North Star ADVANTAGE). The word ADVANTAGE must be in all capitals, and is not to be trademarked (™).

---

# 6 Cooperative Advertising Program

---

## Approved Product List

August 1, 1982

Purchases of the following products count toward co-op accruals. Please use this list in figuring your Dealer's accruals. This list will be updated to reflect any changes in products offered.

<b>APPLICATION SOFTWARE</b>	<b>PART NUMBER</b>
Accounts Payable	00846, 09008, 09017
Accounts Receivable	00838, 09006, 09016
Application Software Utilities	09018
General Ledger	00828, 09004, 09015
InfoManager II™	00819, 09003, 09014
NorthWord™	00797, 09001, 09012
Inventory Control & Analysis	00855, 00426, 00172
Order Entry & Invoicing	00961, 00491, 00180
PROPAC™	00500
TSS/A Multi-User Operating System	00153
HDSO/ADV Hard Disk Operating System Updates	02073
<b>DOS &amp; BASIC</b>	
Graphics DOS/BASIC	00773
Extended Precision BASIC	11074, 11079
HDOS Hard Disk Operating System	00989
<b>CP/M®</b>	
MicroPlan™	00966
WordStar™	02087
SpellStar™	02110
MailMerge™	02100
Pascal-80	02120
FORTRAN	00701
COBOL	00713
Graphics CP/M 2.2	00790
CP/M 2.2 Rev. 1.1.0	09010
TSS/C Multi-User Operating System	00886
TSS/C & 32 HRAM Package	85026
dBASE II™	02073
MSDOS™	02324
NorthNet™ Software Set	02295
<b>DOCUMENTATION ONLY PACKAGES</b>	(all software & hardware)

# 6 Cooperative Advertising Program

---

## Approved Product List (continued)

### HARDWARE

North Star ADVANTAGE	all configurations
HORIZON®	all configurations
Hard Disk	
18Mb	all configurations
5Mb	all configurations
Tape Backup	all configurations
Boards	
HRAM-32 & -64	00129-03, 00129-01
HSIO-4	00135
ZPB	70814
SIO	00862
PIO	00863
8/16 Upgrade	02333
8/16 64K RAM Add-on	02335
Workstation Board	02338
Server Board	02339
Repeater	02341

Please note that printers, CRTs, miscellaneous parts and supplies, dealer's service products, freight, and repair charges are not included.

If you have any questions on how accruals are figured, please contact the Marketing Communications Department.



# 6 North Star Marketing Support

---

## Dealer Programs

### Ad Slicks

The following pages contain camera ready advertising graphics and copy that you may wish to use for creating your own advertisements. There are three basic categories included:

1. North Star logos.
2. Ad slicks and sample copy closely relating to the style and message of our "No business is too small for a North Star" Campaign.
3. General graphics and copy relating strictly to our products.

Radio advertising sample scripts will also be provided as soon as they have been completed.

**No business is too small for a**  
**NORTH STAR**



**The economical business computer that does it all.**

When it comes to bookkeeping, word processing, mailing lists, and other office paperwork, North Star's HORIZON® can do it all. And at significantly less cost

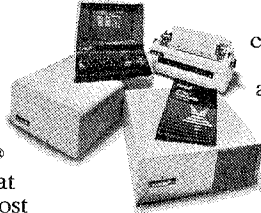

than other office computer systems. To learn more about North Star's economical HORIZON business systems, call us today.

FOLLOW THE STAR  
**NorthStar**  
North Star Computers, Inc.

NorthStar™

NorthStar™

NorthStar™

NorthStar™

NorthStar™

NorthStar™

NorthStar™

NorthStar™

NorthStar™

NorthStar™

NorthStar™

NorthStar™

NorthStar™

NorthStar™

NorthStar™

NorthStar™

NorthStar™

NorthStar™

NorthStar™

NorthStar™

NorthStar™

NorthStar™

NorthStar™

NorthStar™

NorthStar™

NorthStar™

NorthStar™

NorthStar™

NorthStar™

NorthStar™

NorthStar™

# No business is too **NORTH STAR** small for a



## The economical business computer that does it all.

Even the smallest business can run into some big headaches when it comes to bookkeeping, mailing lists, and word processing. That's why North Star developed the HORIZON®—the office computer system which offers the economical solution to your business systems problems.

Easy to install and operate, the North Star HORIZON lets you add programs, work

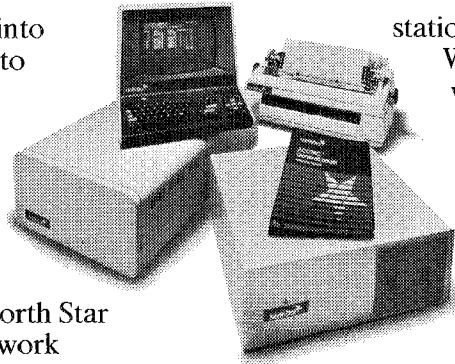

stations, and memory as you need them. What's more, we back our systems with a worldwide sales and service network. Small wonder, then, that more than 28,000 HORIZONS are in operation around the world.

To find out how the North Star HORIZON can meet your particular business systems needs, call us today.

FOLLOW THE STAR  
**NorthStar**<sup>TM</sup>  
North Star Computers, Inc.

# No business is too small for a **NORTH STAR**

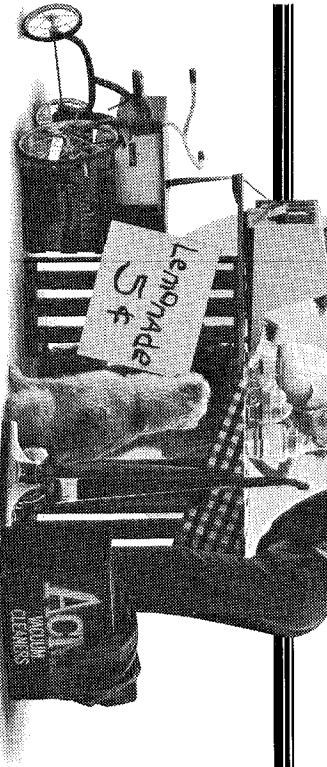

## The economical business computer that does it all.

Even the smallest business can run into some big headaches when it comes to book-keeping, mailing lists, and word processing. That's why North Star developed the HORIZON® — the office computer system which offers the economical solution to your business systems problems. Easy to install and operate, the North Star HORIZON lets you add programs, work stations, and memory as

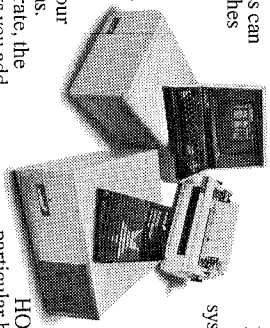

you need them. What's more, we back our systems with a worldwide sales and service network. Small wonder, then, that more than 28,000 HORIZONS are in operation around the world. To find out how the North Star HORIZON can meet your particular business systems needs, call us today.

FOLLOW THE STAR  
**NorthStar**  
North Star Computers, Inc.

# No business is too small for a **NORTH STAR**

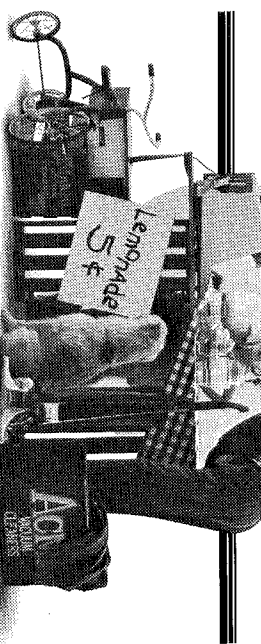

## The economical business computer that does it all.

When it comes to bookkeeping, word processing, mailing lists, and other office paperwork, North Star's HORIZON® can do it all. And at significantly less cost

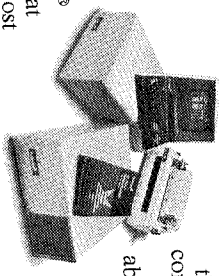

than other office computer systems. To learn more about North Star's economical HORIZON business systems, call us today.

FOLLOW THE STAR  
**NorthStar**  
North Star Computers, Inc.

# North Star has the Advantage over IBM and Apple.

Before you buy a desktop computer, compare these important North Star features with both the IBM PC and the Apple III. Priced from \$3599, the North Star ADVANTAGE gives you more than twice the disk storage per dollar of either the IBM PC or the Apple III.

#### Only North Star offers both 8 bit and 16 bit power.

With our new North Star ADVANTAGE 8/16, you can run industry standard 8 bit CP/M® software plus new 16 bit software (including software available for the IBM PC).

#### Better business graphics.

The North Star ADVANTAGE comes complete with graph preparation software, and its screen precision beats both IBM and Apple.

#### Low-cost expandability and service.

The North Star ADVANTAGE provides cost-effective expandability to meet your growing needs: from 8 bit to 16 bit power, from single user to multi-user networks and from floppy disk to higher capacity Winchester storage. And only North Star offers you a choice of carry-in or on-site service.

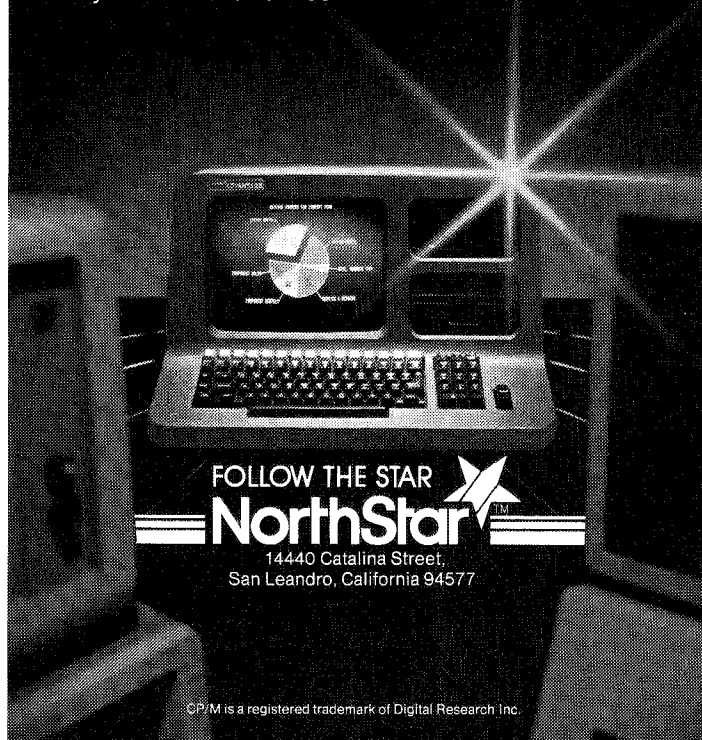

(dealer name/address here)

# North Star has the Advantage over IBM and Apple.

Before you buy a desktop computer, compare these important North Star features with both the IBM PC and the Apple III. Priced from \$3599, the North Star ADVANTAGE gives you more than twice the disk storage per dollar of either the IBM PC or the Apple III.

#### Only North Star offers both 8 bit and 16 bit power.

With our new North Star ADVANTAGE 8/16, you can run industry standard 8 bit CP/M® software plus new 16 bit software (including software available for the IBM PC).

#### Better business graphics.

The North Star ADVANTAGE comes complete with graph preparation software, and its screen precision beats both IBM and Apple.

#### Low-cost expandability and service.

The North Star ADVANTAGE provides cost-effective expandability to meet your growing needs: from 8 bit to 16 bit power, from single user to multi-user networks and from floppy disk to higher capacity Winchester storage. And only North Star offers you a choice of carry-in or on-site service.

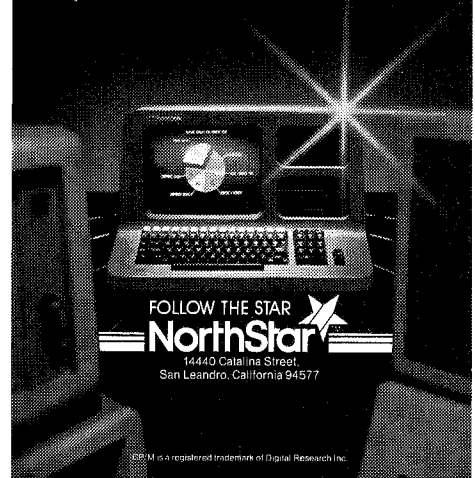

(dealer name/address here)

FOLLOW THE STAR  
**NorthStar**

North Star Computers, Inc. 14440 Catalina Street  
San Leandro, CA 94577, USA

# 7 North Star Technical Services

---

## Introduction

North Star Computers, Inc. recognizes that technical support of the Authorized Dealer family is essential for you to profitably provide our products to your customers. This means we must provide a variety of technical support programs that range from factory maintenance service through full technical documentation of our products. North Star provides such a range of support as listed below:

- Factory Maintenance Service.
- ON-SITE Service Programs.
- Authorized Service Centers.
- Module Exchange Program.
- Technical telephone support for answers to technical questions on hardware or software.
- Seminars for training your technicians on North Star hardware and software products.
- Trouble reporting system for you to report software bugs or errors with assurance they will be promptly handled.
- Field Change Notices and Technical Bulletins to keep you aware of equipment changes, technical data and service “hints”.
- Technical documentation for all North Star hardware and software.

This section provides a detailed description of these support services and the procedures for using them.

NOTE: ALL PRICES QUOTED IN THIS SECTION ARE SUBJECT TO CHANGE WITHOUT PRIOR NOTICE.

North Star Computers, Inc. may, at its option, amend or cancel any of the programs or policies described in this section at any time.

# 7 North Star Technical Services

---

## Levels of Service

North Star has established three levels of Service to accommodate your business strategy. You decide whether to:

1. Provide **full** maintenance service to your customers, using either your own maintenance or MAI/Sorbus ON-SITE Service.
2. Provide maintenance or service yourself by utilizing North Star Factory Service, a local Authorized Service Center or MAI/Sorbus “Carry-In” Service.
3. Refer your customers to MAI/Sorbus “Carry-In” Service or a local Authorized Service Center.

### **Services You May Choose**

1. North Star Factory Maintenance Service
2. Authorized Service Center (ASC)
3. Third Party Service through MAI/Sorbus

### **For Warranty Repairs You May:**

1. Return defective module to North Star Product Service for warranty repair.
2. Have defective module repaired by a local ASC, or Sorbus “Carry-In” Service.
3. Have end user sign up for ON-SITE Service with Sorbus.

### **For Non-Warranty Repairs You May:**

1. Replace the defective module at customer’s expense and return it to North Star for Fixed-Fee repair.
2. Replace or remove the defective module at customer’s expense and utilize North Star Module Exchange Program for 48 hour turn-around.
3. Replace or remove the defective module at customer’s expense and have it repaired at a local ASC, or Sorbus “Carry-In” Service.
4. Refer customer to a local ASC or MAI/Sorbus for “contract” maintenance service.

# 7 North Star Technical Services

---

## Levels of Service

### **Level A - North Star Factory Service**

The North Star Product Repair Center at its San Leandro, California facility will provide North Star Distributors, Dealers, OEMs and Authorized Service Centers complete warranty and non-warranty repairs, upgrades, modifications and retrofits for all North Star products. The Product Repair Center will also maintain a module bank (*Module Exchange Program*) for expedited exchange of defective subassemblies.

### **Level B - North Star Authorized Service Centers**

North Star Authorized Service Centers will provide prompt warranty and non-warranty repairs for all North Star products. A North Star Authorized Service Center (ASC) may also (at its option) provide end user on-site maintenance either by contract or based on an acceptable hourly service rate. A list of North Star Authorized Service Centers can be found in Appendix A of this section.

### **Level C - Third Party Service**

MAI/Sorbus Service Division will provide ON-SITE Service to North Star users during both the warranty and post warranty periods for all North Star products. ON-SITE Service is not available outside of the continental United States and not available in all domestic locations. Additional information on ON-SITE service can be obtained by calling Sorbus at (800) 345-1262. In Pennsylvania call (215) 296-6000. A list of current ON-SITE serviceable areas can be found in Appendix B of this section. At selected locations, MAI/Sorbus also offers a "Carry-In" service for those customers that will not commit to a monthly maintenance fee and are willing to deliver and pick-up equipment at the Sorbus Service Center. A list of current "Carry-In" locations can be found in Appendix B of this section.

At selected locations, MAI/Sorbus also offers a "Carry-In" service for those customers that will not commit to a monthly maintenance fee and are willing to deliver and pick-up equipment at the Sorbus Service Center. A list of current "Carry-In" locations can be found in Appendix B of this section.



# 7 North Star Technical Services

---

## Description of Service Policies

### **North Star Limited Factory Warranty Repair Policy**

All North Star Distributors, Dealers, and OEMs are entitled to take advantage of the North Star Limited Factory Warranty Repair policy. This policy provides for return of a defective module under warranty for repair or replacement by North Star Product Service. This policy will be consistent with the Terms & Conditions specified in the contract signed by North Star Computers, Inc. and the customer. Any module listed in Appendix D may be returned to North Star for warranty repair. Returned items must be shipped prepaid to the North Star Product Repair Center. Shipping costs for returning the replaced or repaired module will be paid by North Star. Any item returned to North Star for warranty repair and found to be free of defects will incur a \$60.00 (no problem found) handling fee. Procedures for returning items for warranty repair are covered further on in this section.

Factory Warranty Service is limited to North Star Authorized Dealers, Distributors, OEMs and Authorized Service Centers only. End users must file all warranty claims through the retail outlet where the product was purchased or a nearby ASC. If the retail outlet does not provide service then the retail outlet must either make arrangements with an ASC or obtain the product from the end user and return the product to North Star Product Service. North Star Product Service will not accept product for repair from end users.

The Dealer must provide North Star with proof of purchase date to establish Warranty status. North Star will accept the following for determining warranty status:

- 90 days from end-user invoice date.
- 90 days from receipt of North Star Warranty Card.
- 120 days from shipment from North Star.

# 7 North Star Technical Services

---

## Description of Service Policies

### **Warranty Repair by Authorized Service Centers**

All Authorized Service Centers will perform end user warranty service regardless of the point of purchase. Warranty service is intended to provide the end user with prompt repairs of all North Star products which fail during the warranty period. All warranty service performed by an ASC will be consistent with the currently published North Star Standard Warranty Policy \*. ASC warranty repairs may be performed by module swap or by component replacement at the option of the ASC. Any module listed in Appendix D may be returned to an ASC for warranty repair. A Warranty Reimbursement Plan is offered to Authorized Service Centers by North Star Computers, Inc. for this service.

### **National ON-SITE Service During Warranty Period**

Retail customers in many areas within the continental United States can now take advantage of North Star's ON-SITE Service Program. ON-SITE Service is available during the warranty period as well as during the post warranty period. End users can opt to have MAI/Sorbus perform repairs on all North Star products at their location during the warranty period at a 20% discount from the standard Sorbus monthly maintenance rate. The customer must fill out the ON-SITE Registration Card enclosed within the North Star packaging and select either 3 or 12 month service within ten (10) days of the date of purchase to qualify for this substantial savings. All administrative details including billing will be handled by Sorbus.

A list of cities where ON-SITE Service through Sorbus can be found in Appendix B of this section. Appendix C provides pricing information for ON-SITE Service.

\* Ref. North Star Terms and Conditions of Sale - Sec. 5

# 7 North Star Technical Services

---

## Description of Service Policies

### **North Star Fixed Fee Repair Program**

North Star Computers, Inc. will perform non-warranty repair on any assembly listed in Appendix E based on the fixed fee schedule shown. This program is currently available to all Distributors, Dealers, OEMs and ASCs.

Any assembly returned to North Star Computers, Inc. for non-warranty repair must be shipped prepaid to North Star Product Repair Center. Shipping costs for returning the repaired module will be paid by North Star. North Star Product Repair Center will provide a 15-30 day turn-around on all repairs. All repaired assemblies will carry a 60 day standard North Star limited warranty (commencing on the date shipped from North Star).

North Star Computers, Inc. reserves the right to refuse fixed fee repair of any assembly which was originally sold in kit form, has parts missing, has suffered catastrophic failure or fails to meet the minimum acceptable revision level standards for the assembly. In the event that North Star deems the assembly unacceptable for any of the above reasons, North Star Product Service will contact the customer and so advise. The customer may then request that the assembly be returned "as is" or request that the assembly be repaired by North Star Product Service on a time-and-materials basis. Procedures for using the Non-Warranty Repair Program are found further on in this section.

### **Important Notes**

The Current Labor Rate for In Shop Repairs is \$45.00 per hour.

Material (parts) pricing is based on North Star published list price with appropriate discounts applied.

Fixed Fee charges and hourly labor rates are subject to change without prior notice.

# 7 North Star Technical Services

---

## Description of Service Policies

### **North Star Module Exchange Program**

All DOMESTIC (US) North Star Distributors, OEMs, Dealers and ASCs are entitled to take advantage of the North Star Module Exchange Program. The program is designed to provide a low cost, quick turn-around on replacement modules for all North Star products. The Module Exchange Program will be expanded to include International North Star Dealers, Distributors and OEMs as soon as we work out the complex details of fast turn-around parts transportation, customs regulations and duty implications.

North Star will ship a replacement module (freight prepaid via air) within 48 hours of receipt of request from one of the above mentioned North Star Authorized Sales or Service Outlets. Upon shipment of the replacement module, North Star will bill the customer account for the "new part list price" of the module. If the defective module is returned freight prepaid to North Star within 15 days of shipment of the replacement module from North Star, the account will be credited with the "new part cost" and debited for the exchange price of the module as specified in Appendix F. If the module is not returned within 15 days, the "new part list price" will be entered for collection.

North Star will maintain an inventory of all modules listed in Appendix F at the North Star Product Repair Center in San Leandro, California. Module Exchange Banks may be opened in additional locations in the future. All modules will carry a 60 day standard North Star limited warranty (commencing on the date shipped from North Star) and will be to CURRENT REVISION LEVEL STANDARDS.

Procedures for using the Module Exchange Program are found further on in this section.

### **Important Notes**

All modules are shipped from North Star's Module Exchange Bank in the current standard North Star configuration. Modules which have been modified in any way (including options) or built from kits are not subject to exchange.

North Star reserves the right to refuse exchange modules which have parts removed, have been modified or have experienced catastrophic failure.

# 7 North Star Technical Services

---

## Description of Service Policies

### **Non-Warranty Services Offered by an ASC**

All Authorized Service Centers are required to provide carry-in service for any North Star user requesting service. All warranty and non-warranty service must be accepted by an Authorized Service Center regardless of the point of sale. North Star requests that in-shop rates be fair for the services rendered in the local area.

An Authorized Service Center may, at its option offer on-site service to North Star users either under a maintenance contract or on a Time and Material basis. North Star requests that on-site service rates be fair for the services rendered in the local area.

### **Non-Warranty Services Offered by MAI/Sorbus**

MAI/Sorbus will provide North Star users with ON-SITE maintenance contracts for all North Star products. ON-SITE service contracts are administered by Sorbus. Monthly Maintenance Charges can be found in Appendix C of this section. Further details on Sorbus ON-SITE Service can be obtained by calling Sorbus Account Administration at (800) 345-1262 (Pennsylvania residents call (215) 296-6000 or the nearest Sorbus office).

MAI/Sorbus will also provide Carry-In and Mail-In service in certain locations. Details on Sorbus Carry-In service can be obtained by calling the above number.

# 7 North Star Technical Services

---

## Technical Support

### Telephone Support

North Star provides two separate Technical Support telephone lines for Dealer personnel to call for answers to technical questions.

For Systems-oriented questions the **Hardware and Systems Software support line** is:

**(415) 357-6990**

For Application-oriented questions the **Application Software support line** is:

**(415) 357-4356**

These numbers are available for use every workday between the hours of 8:30 AM and 3:00 PM **Pacific Time**. Due to the large number of calls North Star Tech Support receives, it is not always possible to get immediate answers to your questions. In these cases, our Support Line receptionist will take your name, telephone number, name of your business and information relating you to your inquiry. One of our Technical Support Specialists will return your call as soon as possible.

**NOTE: THE TECHNICAL SUPPORT LINE WILL NOT ACCEPT CALLS FROM  
END USERS**

### Technical Bulletins

Technical Bulletins will be issued on an as needed basis to keep Dealers, Distributors, OEMs and ASCs abreast of new developments, service tips and procedures, changes to parts lists, etc.

### Field Change Notices

Field Change Notices will be issued whenever North Star or one of its OEM suppliers makes a change to a product affecting form, fit or function.

# 7 North Star Technical Services

---

## Technical Training

### **HARDWARE SERVICE SEMINARS**

North Star provides its Authorized Dealers, Distributors and OEMS with a variety of technical seminars. A brief description of these seminars can be found below.

**ADVANTAGE Orientation:** A three day course giving an overview of North Star's new ADVANTAGE computer. It will cover the hardware at a block-diagram level, system software and the graphics capabilities. The Floppy Disk and 5MB Hard Disk drives are explained with a hands-on demonstration of disk drive alignment. Emphasis is placed on troubleshooting and diagnostic techniques with time allotted for hands-on exercises. A good knowledge of digital electronics and North Star DOS is recommended.

**HORIZON Orientation:** This three day course covers all the hardware of the HORIZON computer system at a block-diagram level. It is oriented towards the non-technical dealer who needs to know how to install, configure and troubleshoot the system. Subjects covered include all the HORIZON subassemblies, the HD18 Hard Disk Drive and the Tape Backup System, with an explanation of disk formatting and checkout procedures. Both 5¼" hard and floppy disks are covered during the ADVANTAGE Orientation class. Time has been scheduled for hands-on exercises during the course. Some knowledge of digital logic is recommended.

**HORIZON and ADVANTAGE Maintenance:** A four day course for experienced technicians, it covers all of North Star's products at the component level. Emphasis is placed on diagnosis and repair techniques with extensive time for hands-on exercises. All the HORIZON and ADVANTAGE subassemblies are covered as well as the hard and floppy disk drives and the Tape Backup System. Prior attendance at the Hardware Orientation courses is recommended. Priority is given to authorized service centers with space available to any dealer meeting prerequisite.

### **REGISTRATION INFORMATION**

To enroll in any of the seminars listed, contact the North Star Training Registrar at (415) 357-8500 x582. We urge you to register well in advance as most North Star seminars fill prior to seminar date. We also suggest you provide an alternate seminar date to assure that we can accommodate you.

After receipt of your training request, the training center will provide a written confirmation of your registration along with local hotel information and directions to the training seminars.

Advanced Registration is advised as North Star cannot guarantee a reservation unless a purchase order is received two weeks prior to the scheduled seminar.

North Star reserves the right to cancel any seminar due to insufficient enrollment. If this occurs, all enrollees will be notified as soon as possible.

# 7 North Star Technical Services

---

## Administration

### Return Procedures—North Star Product Services

NOTE: All items being returned to North Star Computers, Inc. for any reason MUST be accompanied by a Material Return Form & RMA Number. The RMA Number is obtained by calling your North Star Sales Administrator at (415) 357-8500. The RMA Number MUST be included on the Material Return Form (described below) AND CLEARLY marked on the address label of the box in which the defective module is being returned to North Star. FAILURE TO CONFORM TO THE ABOVE REQUIREMENTS WILL RESULT IN NORTH STAR REFUSING RECEIPT OF THE SHIPMENT.

Before calling North Star for an RMA Number fill out the Material Return Form as shown in Figure 1 as follows:

1. Enter DATE you are requesting RMA Number.
2. Enter DATE OF end-user PURCHASE (if claiming a warranty repair).
3. Enter name of DEALER where system was PURCHASED.
4. Enter the ORIGINAL North Star INVOICE NUMBER (if claiming warranty).
5. Enter your DEALER NUMBER. Your DEALER NUMBER MUST be entered on the form. Failure to do so will cause possible delay in crediting your account with the return. If you do not know your DEALER NUMBER leave this section blank for the moment and ask your Sales Administrator for this information when you call. Then make note of the number for future returns.
6. Enter the NORTH STAR PART NUMBER of the item you are returning.
7. Enter the PART DESCRIPTION of the item you are returning.
8. Enter the REVISION LEVEL of the item you are returning.
9. Enter the SERIAL NUMBER of the item you are returning.
10. Enter the FAILURE SYMPTOM CODE for the defective module. Failure Code information can be found on the reverse side of the Material Return Form.
11. Check the appropriate box for type of return.





# 7 North Star Technical Services

---

## Administration

12. Please enter any additional COMMENTS you may have regarding the failure symptoms of the defective module (tests you may have run to determine failure mode, how long the module works before failing if heat related, any parts you may have already replaced, etc.). This will help our technicians considerably during repair.

**NOW, CALL YOUR NORTH STAR SALES ADMINISTRATOR FOR YOUR RMA NUMBER.**

Your Sales Administrator will ask you for some of the information you have just entered on the Material Return Form. The Sales Administrator will then issue you an RMA Number.

13. Enter the RMA Number on the Material Return Form.
14. Package the defective module AND the Material Return Form in the "North Star approved shipping container."

NOTE: North Star will not accept any liability for damage to any item returned in insufficient packaging. Furthermore, any item received by North Star in packaging other than "original container or North Star approved shipping container" will be repackaged by North Star Product Service, the customer incurring the expense of the packaging.

15. CLEARLY write the RMA Number on the address label of the box as shown in Figure 2.

<p style="text-align: center;"><b>PRODUCT SERVICE NORTH STAR COMPUTERS, INC. 14310 CATALINA STREET SAN LEANDRO, CALIFORNIA 94577</b></p> <p style="text-align: center;">RMA NUMBER: (<u>enter RMA NUMBER here</u>)</p>
--

Figure 2  
Sample Shipping Label

16. Ship the package FREIGHT PREPAID.

# 7 North Star Technical Services

---

## Administration

### **Authorized Service Center Return Procedures**

North Star Authorized Service Centers each have their own return procedures. If using an Authorized Service Center for repairs please check with the ASC for details on returning goods.

### **ON-SITE Service Registration**

Beginning with January, 1982 shipments, all HORIZON® and North Star ADVANTAGE Computers and HD-18 Hard Disk Systems contain an "ON-SITE Service Registration Pack" enclosed within the packaging. This form includes a price list and a two-part registration card. Instructions on how to register for ON-SITE Service and an explanation of the program are part of the registration card.

It is suggested that all Dealers, Distributors and OEMs go over the various service options with the retail customer at the point of sale. This gives you the opportunity to advise the user of the benefits of ON-SITE Service through Sorbus, on-site or carry-in service through a local ASC, or, if you prefer to provide service yourself, to discuss the benefits your service organization has to offer. Also, you should explain the standard North Star Limited Factory Warranty.

Should the end user opt ON-SITE Service through Sorbus:

1. Have the customer contact Sorbus Account Management at (800) 345-1262 (Pennsylvania residents call (215) 296-6000) or the nearest Sorbus office to determine if service is available in the area where the equipment will be installed.
2. If service is available, have the user fill out the ON-SITE Registration Card (two prepaid post cards) and mail one card to MAI/Sorbus and the other card to North Star. NOTE: The North Star card must be filled out and returned even if ON-SITE Service is declined or unavailable in the area.
3. Upon Sorbus' receipt of the Registration Card, arrangements will be made for the local Sorbus Service Manager to contact the end user and set up service.
4. From that point on Sorbus will handle all administrative details directly with the end user.

### **Ordering Spare Parts**

All North Star Authorized Dealers, Distributors, OEMs and ASCs may purchase spare parts for North Star products by following the standard ordering procedures outlined in Section 5 of this manual. A minimum order of \$50.00 is required. A list of suggested spare parts for each of North Star's products can be found in Appendices H through J of this section. These Parts Lists indicate North Star Part Number, Description, Suggested Retail Price and Suggested Stocking Levels.

# **7 North Star Technical Support**

---

## Appendicies

**NORTH STAR TECHNICAL SERVICES**

**APPENDIX A**

**NORTH STAR AUTHORIZED SERVICE CENTERS**

**NOTE:** This appendix will be added as soon as Authorized Service Centers are in place.

# 7 North Star Technical Support

---

## Appendicies

### NORTH STAR TECHNICAL SERVICES

#### APPENDIX B

#### LIST OF NORTH STAR ON-SITE SERVICE LOCATIONS (as of 5/1/82)

ATLANTA, GA	BOSTON, MA	CHICAGO, IL	CLEVELAND, OH
DALLAS, TX	DENVER, CO	DETROIT, MI	HOUSTON, TX
LONG ISLAND, NY	LOS ANGELES, CA	MIAMI, FL	MINNEAPOLIS, MN
NEW YORK, NY	ANAHEIM, CA	PITTSBURGH, PA	PHILADELPHIA, PA
SAN FRANCISCO, CA	ST. LOUIS, MO	WASHINGTON, D.C.	WICHITA, KS

#### ON-SITE SERVICE LOCATIONS DUE TO OPEN AUGUST 1982

BUFFALO, NY	CLIFTON, NJ	KANSAS CITY, MO	MEMPHIS, TN
MILWAUKEE, WI	NEW ORLEANS, LA	OKLAHOMA CITY, OK	PHOENIX, AZ
SAN DIEGO, CA	SEATTLE, WA		

**NORTH STAR TECHNICAL SERVICES**

**APPENDIX C**

**ON-SITE SERVICE  
PRICE LIST**

Product Description	3-Month ON-SITE Service Price	12-Month ON-SITE Service Price	Standard Sorbus Monthly Charge
<b>HORIZON®:</b>			
Single User			
2Q-64K	\$ 96.00	\$384.00	\$ 40.00
1Q-HD-5-64K	163.00	652.00	68.00
Multi-Users* (1Q HD-18)			
2 users	252.00	1,008.00	105.00
3 users	276.00	1,104.00	115.00
4 users	300.00	1,200.00	125.00
5 users	324.00	1,296.00	135.00
<b>North Star ADVANTAGE:</b>			
Single User (2Q-64K)	\$ 86.00	\$344.00	\$ 36.00
Single User (1Q-HD-5-64K)	154.00	614.00	64.00
<b>ADDITIONAL BOARDS:</b>			
HRAM-32-K Memory Board	\$ 14.00	\$ 56.00	\$ 6.00
HRAM-64K Memory Board	24.00	96.00	10.00
FPB Floating Point Board	7.00	28.00	3.00
HSIO-4 Four Port Serial I/O	12.00	48.00	5.00
<b>HARD DISK SYSTEMS</b>			
HD-18 18Mb Hard Disk System	\$132.00	\$528.00	\$ 55.00
HD-5 5Mb Hard Disk System	79.00	316.00	33.00

Applicable state and local taxes are to be added to the above amounts. These prices are subject to change without prior notice.

\*Includes necessary 64K HRAM board per user and one HSIO-4 board per system.

---

**NORTH STAR TECHNICAL SERVICES**  
**APPENDIX D**  
**ASSEMBLIES RETURNABLE UNDER WARRANTY**

---

North Star P/N	Part Description
00102	PCB, MAIN ASSY, ADVANTAGE
00113	PCB, SIO, ADVANTAGE
00148	PCB, PIO, ADVANTAGE
00152	PCB, HD-5 CONTROLLER, HORIZON®
00157	PCB, HD-5 CONTROLLER, ADVANTAGE
08006	PCB, MB-4 (HORIZON MOTHERBOARD)
08008	PCB, FPB-A (FLOATING POINT BOARD)
08009	PCB, MDS-CTRL-D (MDS CONTROLLER)
08014	PCB, ZPB-A (Z80A® PROCESSOR BOARD)
00134	PCB, HSIO-4 (MULTI USER SIO BOARD)
00128-03	PCB, HRAM-32 (32K HRAM BOARD)
00128-02	PCB, HRAM-48 (48K HRAM BOARD)
00128-01	PCB, HRAM-64 (64K HRAM BOARD)
08020	PCB, HD-18 (HARD DISK CONTROLLER BOARD)
00234	PCB, MARKSMAN (CENTURY DATA NEVADA BOARD)
00357	KEYBOARD, ADVANTAGE
00495	POWER SUPPLY ASSY, HD-5, HORIZON
00580	DRIVE, HD-5
49002	DRIVE, TANDON TM100-2
92XXX	HORIZON COMPUTER, COMPLETE
9440X	NORTH STAR ADVANTAGE COMPUTER, COMPLETE
82001	HDS-18 HARD DISK SYSTEM
02333	PCB—8/16 UPGRADE
02335	PCB—8/16 64K RAM ADD-ON
02338	PCB—WORKSTATION BOARD
02339	PCB—SERVER BOARD
02341	MODULE—REPEATER

---

**NORTH STAR TECHNICAL SERVICES**

**APPENDIX E**

**FIXED FEE SCHEDULE**

North Star P/N	Part Description	Repair Price
00102	PCB, MAIN ASSY, ADVANTAGE	\$174.00
00113	PCB, SIO, ADVANTAGE	66.00
00148	PCB, PIO, ADVANTAGE	66.00
00152	PCB, HD-5 CONTROLLER, HORIZON®	108.00
00157	PCB, HD-5 CONTROLLER, ADVANTAGE	108.00
00357	KEYBOARD, ADVANTAGE	66.00
00495	POWER SUPPLY, HD-5, HORIZON	40.00
08006	PCB, MB-4 (HORIZON MOTHERBOARD)	66.00
08008	PCB, FPB-A (FLOATING POINT BOARD)	120.00
08009	PCB, MDS-CTRL-D (MDS CONTROLLER)	108.00
08014	PCB, ZPB-A (Z80A PROCESSOR BOARD)	80.00
00134	PCB, HSIO-4 (MULTI USER SIO BOARD)	66.00
08012	PCB, RAM-16 (16K RAM BOARD)	66.00
08013	PCB, RAM-32 (32K RAM BOARD)	80.00
00128-03	PCB, HRAM-32 (32K HRAM BOARD)	80.00
00128-02	PCB, HRAM-48 (48K HRAM BOARD)	95.00
00128-01	PCB, HRAM-64 (64K HRAM BOARD)	108.00
08020	PCB, HD-18 (HARD DISK CONTROLLER BOARD)	108.00
00234	PCB, MARKSMAN (CENTURY DATA NEVADA BOARD)	480.00
00580	DRIVE, HD-5	400.00
49001	DRIVE, SHUGART SA-400	150.00
49002	DRIVE, TANDON TM100-2	168.00
49004	SEALED ASSY, HD-18	600.00
9440X	ADVANTAGE COMPUTER COMPLETE	see note
92XXX	HORIZON COMPUTER COMPLETE (DOUBLE DENSITY)	see note
94XXX	HORIZON COMPUTER COMPLETE (QUAD DENSITY)	see note
80001	HDS-18 HARD DISK SYSTEM COMPLETE	see note

FIXED FEES AND CURRENT HOURLY LABOR RATES QUOTED ARE SUBJECT TO CHANGE WITHOUT PRIOR NOTICE.

ONLY ASSEMBLIES LISTED ABOVE WILL BE ACCEPTED FOR REPAIR.

FIXED FEE CHARGES FOR COMPLETE UNITS (HORIZON AND ADVANTAGE COMPUTERS AND HARD DISK SYSTEMS) WILL BE BASED ON THE FIXED FEE CHARGE FOR THE ASSEMBLY(IES) FOUND TO BE DEFECTIVE. AN ADDITIONAL \$75.00 WILL BE CHARGED TO COVER THE COSTS OF COMPLETE SYSTEM TESTING.



**NORTH STAR TECHNICAL SERVICES**  
**APPENDIX F**  
**EXCHANGE MODULES**

North Star P/N	Part Description	Exchange Price
00102	PCB, MAIN ASSY, ADVANTAGE	\$209.00
00113	PCB, SIO, ADVANTAGE	79.00
00148	PCB, PIO, ADVANTAGE	79.00
00152	PCB, HD-5 CONTROLLER, HORIZON®	130.00
00157	PCB, HD-5 CONTROLLER, ADVANTAGE	130.00
08006	PCB, MB-4 (HORIZON MOTHERBOARD)	79.00
08008	PCB, FPB-A (FLOATING POINT BOARD)	144.00
08009	PCB, MDS-CTRL-D (MDS CONTROLLER)	130.00
08014	PCB, ZPB-A (Z80A® PROCESSOR BOARD)	96.00
00134	PCB, HSIO-4 (MULTI USER SIO BOARD)	79.00
08012	PCB, RAM-16 (16K RAM BOARD)	79.00
08013	PCB, RAM-32 (32K RAM BOARD)	96.00
00128-03	PCB, HRAM-32 (32K HRAM BOARD)	96.00
00128-02	PCB, HRAM-48 (48K HRAM BOARD)	114.00
00128-01	PCB, HRAM-64 (64K HRAM BOARD)	130.00
08020	PCB, HD-18 (HARD DISK CONTROLLER)	96.00
00234	PCB, MARKSMAN (HD-18 NEVADA BOARD)	576.00
00357	KEYBOARD, ADVANTAGE	79.00
00495	POWER SUPPLY ASSY HD-5, HORIZON	48.00
00580	DRIVE, HD-5	480.00
49001	DRIVE, SHUGART SA-400	180.00
49002	DRIVE, TANDON TM100-2	202.00

IMPORTANT—All modules are shipped from North Star's Module Exchange Bank in the standard North Star configuration. Modules which have been modified in any way (including options) are not subject to exchange.

# 7 North Star Technical Support

---

## **Field Service Policies and Procedures**

### **Fixed Fee Repairs Program**

North Star Computers, Inc. will perform non-warranty repair of the assemblies listed in Exhibit A based on the fixed fee schedule shown. This program is currently available to all Distributors, Dealers and OEMs.

Any assembly returned to North Star Computers, Inc. for non-warranty repair must be shipped prepaid to North Star Product Repair Center. Shipping costs for returning the repaired module will be paid by North Star. North Star Product Repair Center will provide a 15-30 day turn-around on all repairs. All repaired assemblies will carry a 60 day standard North Star limited warranty (commencing on the date shipped from North Star).

North Star Computers, Inc. reserves the right to refuse fixed fee repair of any assembly which was originally sold in kit form, has parts missing, has suffered catastrophic failure or fails to meet the minimum acceptable revision level standards for the assembly. In the event that North Star deems the assembly unacceptable for any of the above reasons, North Star Product Service will contact the customer and so advise. The customer may then request that the assembly be returned "as is" or request that the assembly be repaired by North Star Product Service on a time-and-materials basis.

Procedures for using the Non-Warranty Repair Program are found in this document.

### **Important Notes**

THE CURRENT LABOR RATE FOR IN SHOP REPAIRS IS \$40.00 PER HOUR.

MATERIAL (PARTS) PRICING IS BASED ON NORTH STAR PUBLISHED LIST PRICE WITH APPROPRIATE DISCOUNTS APPLIED.

FIXED FEE CHARGES AND HOURLY LABOR RATES ARE SUBJECT TO CHANGE.

# 7 North Star Technical Support

## Field Service Policies and Procedures

**Fixed Fee Repairs Program  
Exhibit C  
Fixed Fee Schedule**

North Star P/N	Part Description	Repair Price
08006	PCB, MB-4 (HORIZON MOTHERBOARD)	\$ 66.00
08008	PCB, FPB-A (FLOATING POINT BOARD)	120.00
08009	PCB, MDS-CTRL-D (MDS CONTROLLER)	66.00
08014	PCB, ZPB-A (Z80 PROCESSOR BOARD)	81.00
00134	PCB, HSIO-4 (MULTI USER SIO BOARD)	66.00
08012	PCB, RAM-16 (16K RAM BOARD)	66.00
08013	PCB, RAM-32 (32K RAM BOARD)	81.00
00128-03	PCB, HRAM-32 (32K HRAM BOARD)	81.00
00128-02	PCB, HRAM-48 (48K HRAM BOARD)	95.00
00128-01	PCB, HRAM-64 (64K HRAM BOARD)	108.00
49001	DRIVE, SHUGART SA-400	159.00
49002	DRIVE, TANDON QUAD	179.00
08020	PCB, HD-18 (HARD DISK CONTROLLER BOARD)	81.00
00234	PCB, MARKSMAN (CENTURY DATA NEVADA BOARD)	450.00
49004	SEALED ASSY, HD-18	650.00
92XXX	HORIZON COMPUTER COMPLETE (DOUBLE DENSITY)	see note
94XXX	HORIZON COMPUTER COMPLETE (QUAD DENSITY)	see note
80001	HDS-18 HARD DISK SYSTEM COMPLETE	see note

Fixed fees and current hourly labor rates quoted are subject to change without prior notice.

Only assemblies listed above will be accepted for repair.

Fixed fee charges for complete units (HORIZON computers and hard disk systems) will be based on the fixed fee charge for assemblies found to be defective. An additional \$25.00 will be charged to cover the costs of complete system testing and shipping costs.

# 7 North Star Technical Support

---

## Field Service Policies and Procedures

### Using The Fixed Fee Repairs Program

NOTE: All items being returned to North Star Computers, Inc. for any reason **MUST** be accompanied by a Material Return Form & RMA Number. The RMA Number is obtained by calling your North Star Sales Administrator at (415) 357-8500. The RMA Number **MUST** be included on the Material Return Form (described below) **AND CLEARLY** marked on the address label of the box in which the defective module is being returned to North Star. **FAILURE TO CONFORM TO THE ABOVE REQUIREMENTS WILL RESULT IN NORTH STAR REFUSING RECEIPT OF THE SHIPMENT.**

Before calling North Star for an RMA Number fill out the Material Return Form as shown in Figure 1 as follows:

1. Enter DATE you are requesting RMA Number.
2. Enter your DEALER NUMBER. Your DEALER NUMBER **MUST** be entered on the form. Failure to do so will cause possible delay in crediting your account with the return. If you do not know your DEALER NUMBER leave this section blank for the moment and ask your Sales Administrator for this information when you call. Then make note of the number for future returns.
3. Enter the NORTH STAR PART NUMBER of the item you are returning.
4. Enter the PART DESCRIPTION of the item you are returning.
5. Enter the REVISION LEVEL of the item you are returning.
6. Enter the SERIAL NUMBER of the item you are returning.
7. Enter the FAILURE SYMPTOM CODE for the defective module. Failure Code information can be found on the reverse side of the Material Return Form.
8. Check the box marked NON-WARRANTY REPAIR.
9. Please enter any additional COMMENTS you may have regarding the failure symptoms of the defective module (tests you may have run to determine failure mode, how long the module works before failing if heat related, any parts you may have already replaced, etc.). This will help our technicians considerably during repair.

NOTE: Sections of the form marked "DATE of PURCHASE", "WHERE PURCHASED" and "ORIGINAL INVOICE NUMBER" are optional for a Non-Warranty repair since warranty status check is not required.

10. **NOW, CALL YOUR NORTH STAR SALES ADMINISTRATOR FOR YOUR RMA NUMBER.**

Your Sales Administrator will ask you for some of the information you have just entered on the Material Return Form. The Sales Administrator will then issue you an RMA Number.



# 7 North Star Technical Support

---

## Field Service Policies & Procedures

11. Enter the RMA Number on the Material Return Form.
12. Package the defective module AND the Material Return Form in "North Star approved shipping container".
13. NOTE: North Star will not accept any liability for damage to any item returned in insufficient packaging. Furthermore, any item received by North Star in packaging other than "original container or North Star approved shipping container" will be repackaged by North Star Product Service, the customer incurring the expense of the packaging.

CLEARLY write the RMA Number on the address label of the box as shown in Figure 2.

<p style="text-align: center;"><b>PRODUCT SERVICE</b> <b>NORTH STAR COMPUTERS, INC.</b> <b>14440 CATALINA STREET</b> <b>SAN LEANDRO, CALIFORNIA</b> <b>94577</b></p> <p>RMA NUMBER: <u>(enter RMA NUMBER here)</u></p>
--

Figure 2  
Sample Shipping Label

14. Ship the package **FREIGHT PREPAID**.

# 7 North Star Technical Support

---

## Hardware Service Seminars

North Star requires any organization desiring to become an Authorized Service Center (ASC) to attend the following Hardware Service Seminars:

**HARDWARE SERVICING LEVEL I** This one day entry level course combines terminal, printer, Hard Disk and HORIZON servicing and troubleshooting techniques. It is intended as an introductory course in system set up and minor repair. It is a requirement for service personnel who wish to operate a North Star Authorized Service Center.

**HARDWARE SERVICING LEVEL II** This two day class provides in depth technical instruction on the theory of operation and checkout procedures for the following subassemblies: ZPB-Z80 processor, 16RAM, 32RAM, HRAM, HSI04 boards, Disk Controller board, and HORIZON motherboard. The seminar also includes practical hands-on exercises in drive alignment procedures. Service personnel should have a basic understanding of digital logic.

**HARD DISK** The content of this one day seminar includes software sessions covering first time use of HD-18, using HDTest, total recovery program, HDOS commands, and back up and recovery procedures. Hardware discussion includes the logical dimensions of the Hard Disk, theory of operation, assembly and disassembly. Participants should have a basic understanding of digital logic.

### REGISTRATION INFORMATION

To enroll in any of the seminars listed, contact the North Star Training Registrar at (415) 357-8500 x 541. We urge you to register well in advance as most North Star seminars fill prior to seminar date. We also suggest you provide an alternate seminar date to assure that we can accommodate you.

After receipt of your training request, the training center will provide a written confirmation of your registration along with local hotel information and directions to the training seminars.

Advanced Registration is advised as North Star cannot guarantee a reservation unless a purchase order is received two weeks prior to the scheduled seminar.

North Star reserves the right to cancel any seminar due to insufficient enrollment. If this occurs, all enrollees will be notified as soon as possible.

# 7 North Star Technical Support

---

## Technical Support Hot-Lines

North Star provides two separate technical support “HOTLINES” for Dealer personnel to utilize for quick answers to technical questions.

For Systems-oriented questions the **Hardware and Systems Software Hotline** is:

415-357-6990

For Application-oriented questions the **Application Software Hotline** is:

415-357-4356

These numbers are available for use every workday between the hours of **10:00 AM and 4:00 PM Pacific Time**.

**Note:** These “HOTLINES” will **NOT** accept calls from end users.