

POLY-88 MICROCOMPUTER SYSTEM
VOLUME II: OPERATION AND SOFTWARE

© 1976 IPC



TABLE OF CONTENTS

| | page |
|--|------|
| A: Introduction to the POLY 88..... | 1 |
| 1. Symbol system..... | 2 |
| a. Number system..... | 2 |
| i) Decimal and binary..... | 2 |
| ii) Octal and hexadecimal..... | 9 |
| b. ASCII..... | 11 |
| 2. Computer languages..... | 12 |
| a. Machine language..... | 12 |
| b. Assembly language..... | 12 |
| c. High level languages..... | 14 |
| 3. Computer theory..... | 14 |
| a. Address and memory..... | 14 |
| b. Central processor architecture..... | 17 |
| c. Instruction set..... | 24 |
| d. Monitor..... | 52 |
| i) ASCII mode..... | 52 |
| ii) Front panel mode..... | 53 |
| B: Operating the System..... | 60 |



POLY 88 Microcomputer System Manual
Vol. II: Operation and Software

A: Introduction to the POLY 88.

The POLY 88 system is designed to be, not only a powerful problem-solver, but also a source of satisfaction and enjoyment. Sophisticated computer users know that computers are interesting as well as useful. To derive the greatest possible value, both practical and aesthetic, from the system, it is important to have both a ready ability to interact with the computer at the level of keyboard and screen and a good sense of what is going on inside the computer at the level of actual electronic events. This volume is intended to show the user how to operate the system, and to convey some measure of awareness of what is going on inside the computer as the user operates it.

You may be quite advanced in your familiarity with computers, or you may just be getting started. Our discussion should be understandable and helpful to the beginner, yet interesting and worthwhile to the expert. We will be moving quickly through the fundamental concepts of symbol systems -- binary and hexadecimal math and ASCII code -- used by computer users, and some useful "languages," especially assembly language, with which we communicate with computers. Then we will consider how a computer accepts, stores, and manipulates data to produce results. Then we will be operating the POLY 88 to see how it works.

If you already have some experience with computers, you will be mainly interested here in reading about those things that are unique to the POLY 88 -- its architecture and its monitor. You will probably just want to skim through Section A.

Section B will give you some hands-on experience with the POLY 88, while Section C and the appendix present in tabular form the information you will want to refer to often.

If your experience with computers is more limited, you will want to go through Section A with care. It discusses binary math, etc., in a way intended to provide some insight into what actually goes on inside the computer. Computer users should be able to picture in their minds what the computer is going through in response to their commands. Indeed, the computer usually performs its operations so fast and replies to its operator so promptly that the operator may have no sense of anything going on between his pushing a key and the appearance of the response on the screen. This "lack of sympathy" is undesirable, because it causes operators to miss much of the aesthetic value of the computer, and in fact prevents them from making full use of the computer (especially a micro-computer like the POLY 88).

The relatively inexperienced computer user may find that our discussion is occasionally hard to follow. He or she will want to re-read and interpret, refer to other texts, and discuss the subject with other people. The authors of this text, however, are determined to make it understandable to the beginner, yet interesting to those who are more advanced.

1. Symbol Systems
 - a. Number Systems
 - i) Decimal and Binary

Binary math is the symbol system that most closely approximates the actual operations of an electronic digital computer. A mechanical computer might use devices having ten different "states," like a disc with the digits 0 through 9 around its edge:



(or discs with ten notches, gears with ten teeth, etc.). The ten "states" of such a disc would be the ten different digits that the disc presents to the view of the human user. In fact, there are such devices, and they might be thought of as being purely "decimal" in operation -- decimal meaning ten.

We could put several such discs together and have them count things. Each disc would be geared to the one next to it, so that when the disc on the right went all the way around once, through all ten digits from 0 through 9, the gear on the left would move one "notch" to its next state.

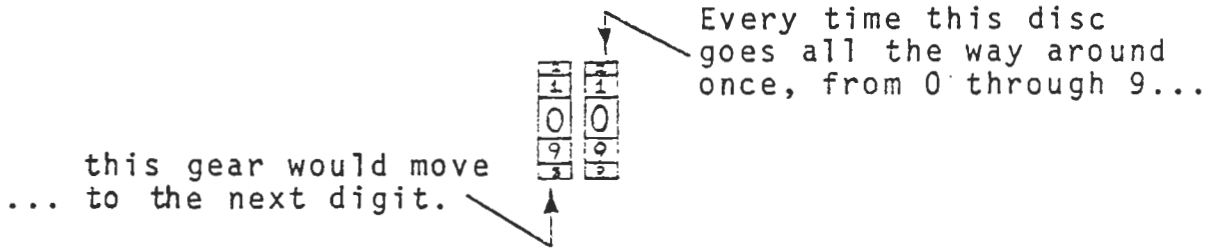

So when the counter had counted nine things, it would read

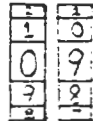

and when it counted one more, it would read:

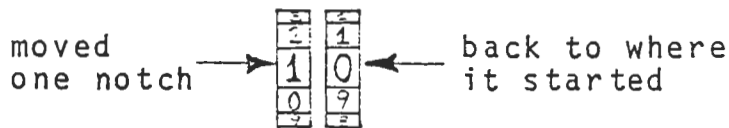

An alternative would be to have just one large disc with many numbers on it -- the numbers 0 to 100, say. But our "decimal discs," each geared to move one number when the gear to its right went all the way around once, would be smaller and handier, and would be able to count very large numbers. In fact, we increase its capacity to count by a factor of ten every time we add another disc. A two-disc counter could count from 0 to 99, while a three-disc counter could count from 0 to 999, and so on.

Actually, this hypothetical counter using decimal discs is a

mechanical analog of the decimal number system itself. Each disc corresponds to a "place" in a decimal number, and the fact that we would want each disc to move by one number when the disc to its right had gone all the way through its ten digits shows that each "place" in a decimal number represents a power of ten, with each place being one power higher than the place to its right.

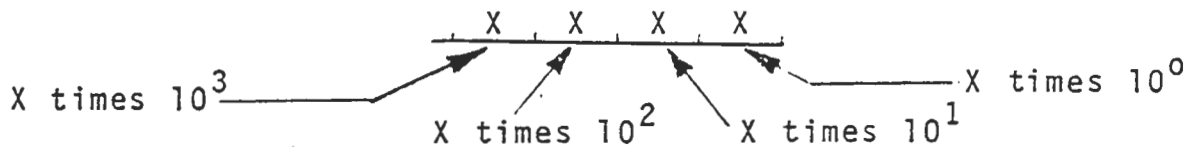

In the decimal system, this number:

324

means "three hundred and twenty-four" because each digit in the number represents a power of ten, thus:

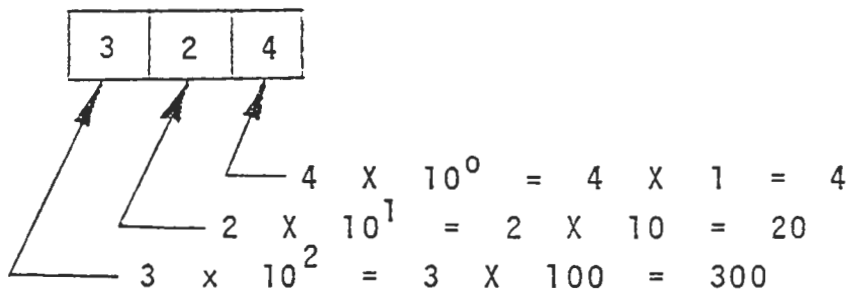

The right-hand place (called the "least significant") in the number is the 10^0 or "ten to the zeroeth" place; the digit occupying that space tells you how many 10^0 s the number contains. Since $10^0 = 1$, this position is called the ones place or ones column. (The zeroeth power of any number is one.) The 4 occupying this column means "four ones." Moving to the left, the next place shows 10^1 or ten. The 2 occupying this place means "two tens." The next place (in this case, the "most significant") indicates 10^2 , or one hundred. Three hundreds, two tens, and four ones -- 324. To express numbers involving

thousands, tens of thousands, etc., we just keep adding places to the left. The left-most place is always the most significant -- it indicates the highest power of the base. Decimal has ten different digits -- 0, 1, 2, 3, 4, 5, 6, 7, 8, 9 -- and so can indicate from 0 to 9 ones in the ones column, from 0 to 9 tens in the tens column, and so forth. Humans, having ten fingers, find decimal or ten-based counting very natural, and many people just cannot believe that other bases are better for some purposes.

Nevertheless, the fact is that any value can be used as a base in a number system. Consider thirty: We say "thirty" and write 30 to represent this quantity. But just as we could use some other word than "thirty" to represent the quantity, so we could apply some other number system. For instance, the base of the number system could itself be thirty. That system would work like this:

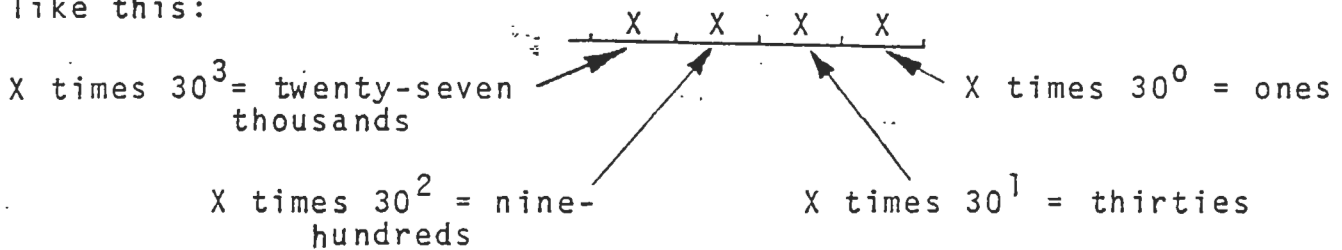

Thirty includes "no ones" and "one thirty," with no nine-hundreds, etc. So in a thirty-based system, the value thirty would be expressed:



In a number system based on three, thirty would be expressed:

1 0 1 0

(Why?)

Just what number is selected to be the base of a number system is a matter of convenience. Creatures having ten fingers find

ten a convenient base. But when you start making devices to help you in computation, it becomes convenient to use other bases as well.

Computers use solid-state electronic devices to perform computations. The simplest, smallest, cheapest solid-state device can take on just two electronic "states." (Recall that the decimal disc had ten states -- the ten different positions it would be in to show each of its ten digits to a viewer.) Such a device is often thought of as a switch. The switch might offer two possible pathways:

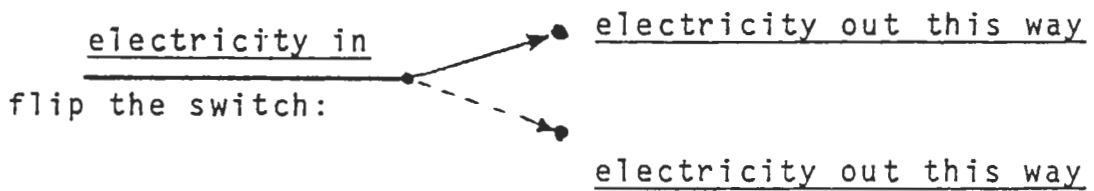

The two stable states of the switch might simply be OPEN and CLOSED -- OFF and ON. The two states can be called YES and NO, or TRUE and FALSE -- or they can be called 1 and 0. This immediately suggests a number system based on just two digits. And in fact, since a computer actually performs its operations by means of many tiny solid-state devices that have two possible stable states, computers are said to "use binary" in their operation. In binary each position or column in a number represents a power of two, rather than a power of ten. This binary number

$$\begin{array}{r}
 1 \quad 0 \quad 1 \\
 \swarrow \quad \swarrow \quad \swarrow \\
 1 \times 2^0 = 1 \times 1 = 1 \\
 0 \times 2^1 = 0 \times 2 = 0 \\
 1 \times 2^2 = 1 \times 4 = 4
 \end{array}$$

says "1 one, 0 twos, and 1 four," or five. In decimal -- 5. In binary -- 101. (We will continue to use written words like "one, two, three" to discuss these other systems.) We will also slash all 0s to distinguish them from O's, as does the POLY 88.)

Obviously, binary numbers are usually longer than decimal numbers. So why use them? Because solid-state electronic devices find them convenient. To be more exact, the binary system is the simplest number system that can convey any and all data. The only simpler system would be to the base one, and that would not be a "system" at all, but just a tally -- ten marks to indicate the number ten. The simplicity of binary allows computer design to be as simple as possible, since the simplest physical system with more than one stable state has two.

Any quantity can be represented in binary. Just keep adding powers of two to the left. Binary digits, or "bits," are frequently grouped in groups of eight:

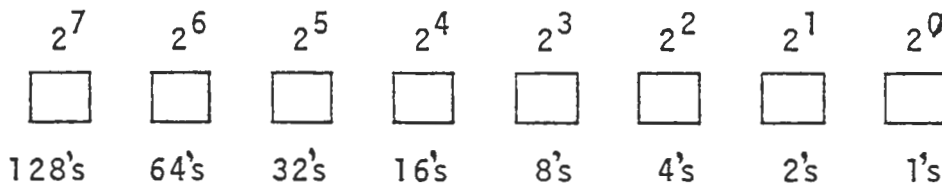

Eight bits is a "byte." The largest number expressible in a byte, obviously, is 11111111, which is (starting from the right) one one, one two, one four, one eight, and so forth. In decimal it would be $1 + 2 + 4 + 8 + 16 + 32 + 64 + 128$, or 255. Larger numbers, of course, are built up from several bytes.

Many computers, the POLY 88 among them, always treat values in eight-bit bytes. For instance, the POLY 88 stores data in its memory in the form of eight-bit bytes. Recall that a binary digit or bit, which is always either 0 or 1, corresponds to a tiny solid-state device which is in one or the other of its two stable states. When you store a data quantity in the POLY 88, you are actually manipulating the states of many such devices. Let us call these two states the "zero state" and the "not zero state." When you store the quantity five in the POLY 88's memory,

you affect the state of eight (microscopically small) devices. Five in binary is 101B, or, as an eight-bit byte, 00000101B. The eight affected devices will be in this overall state:

| | | | | | | | |
|------------|------------|------------|------------|------------|----------------|------------|----------------|
| Zero State | Zero State | Zero State | Zero State | Zero State | Not Zero State | Zero State | Not Zero State |
|------------|------------|------------|------------|------------|----------------|------------|----------------|

Another way to show the state of the eight affected devices is:

| | | | | | | | |
|---|---|---|---|---|---|---|---|
| 0 | 0 | 0 | 0 | 0 | 1 | 0 | 1 |
|---|---|---|---|---|---|---|---|

This is a very convenient way, because here we have our binary number 00000101B over-laid onto the representation of the eight affected devices. We will be using this representation often, because to get the greatest use and the greatest aesthetic satisfaction out of your computer, it is important to "think binary" (at least at first) and visualize the actual events going on down at the level of the bi-stable devices. The "memory" of the computer consists of many, many groups of eight such devices, and can be thought of as many such rows (bytes) as this:

| | | | | | | | |
|---|---|---|---|---|---|---|---|
| 0 | 0 | 0 | 0 | 0 | 1 | 0 | 1 |
|---|---|---|---|---|---|---|---|

turned on edge and grouped together like this:

Memory



each location in memory contains one byte -- eight bits

Binary expresses the actual state of the bi-stable devices or "flip-flops" that make up the computer's memory. As we will be discussing later, binary also expresses the "vectors" or the pathways that lead to the bytes that make up the memory.

ii) Octal and Hexadecimal

Though electronic devices find binary convenient, it is cumbersome for humans. So computer operators use other number systems that are more like decimal in their compactness, namely "octal," based on eight, and "hexadecimal," based on sixteen. Since eight and sixteen are themselves powers of two, numbers in these systems are fairly easy to compare with or convert to binary numbers. Decimal could be used, but it would not convey any sense of the actual state of operations down at the level of the solid-state devices, where the abstraction of numbers has its reality in the form of the electrical state of each device.

Octal uses the digits 0 through 7, with each position indicating up to seven times a power of eight. Hexadecimal is more important for our purposes, since operating the POLY 88 involves its use. Hexadecimal uses all ten of the familiar digits, plus the first six letter of the alphabet: 0123456789ABCDEF.

Each position in a hexadecimal number indicates a power of sixteen, thus:



Clearly, very large numbers can be compactly expressed in hexadecimal. This number, for instance:

F00

Says "no ones, no sixteens, and fifteen two-hundred-fifty-sixes." In decimal -- 3,840. (The hex number above would ordinarily be written F00H and said "F zero zero hex." We will always put an H after a hex number and a B after a binary number; a number with no letter after it is always decimal.)

In binary, by the way, the above hex number is 1111000000000000B. There is no sense in which the decimal number 3,840 is the "real" expression of this value. Any binary number up to four bits can be expressed as one hexadecimal number, thus:

| Binary | Hexadecimal | Decimal |
|--------|-------------|---------|
| 0000B | 0H | 0 |
| 0001B | 1H | 1 |
| 0010B | 2H | 2 |
| 0011B | 3H | 3 |
| 0100B | 4H | 4 |
| 0101B | 5H | 5 |
| 0110B | 6H | 6 |
| 0111B | 7H | 7 |
| 1000B | 8H | 8 |
| 1001B | 9H | 9 |
| 1010B | AH | 10 |
| 1011B | BH | 11 |
| 1100B | CH | 12 |
| 1101B | DH | 13 |
| 1110B | EH | 14 |
| 1111B | FH | 15 |

Recall that in the POLY 88, each memory location consists of eight bi-stable devices, so the contents of any memory location can be expressed in eight binary digits or bits. This eight-bit value can in turn be expressed in two hexadecimal characters. For instance, if you think of the number 11110000B as two groups: 1111 0000, you see that it equals F0 in hex (F0H).

b. ASCII. Binary numbers can be used (like any numbers) in a code to express things other than quantities. One code for us to consider is the American Standard Code for Information Interchange, or ASCII. ASCII provides a means for putting information into a computer and getting it out again in a form that makes sense to the human. In ASCII, the characters the human writes or reads -- upper and lower case letters and the ten digits, plus punctuation marks -- are all assigned numerical values. Every character on a typewriter keyboard, for instance, is assigned a binary equivalent. When the human strikes a key on the computer's input keyboard, the keyboard in turn sends to the computer one byte -- an 8-bit binary number -- corresponding to that key. This is necessary because the computer itself "understands" nothing but binary; it conducts all its operations in terms of the bistable state of electronic connectors

ASCII also enables the computer to put out characters that make sense to the human. If the computer and the human are communicating strictly by means of a typewriter, the process described above simply reverses. The human puts in his/her information by striking the appropriate keys. The keyboard electronics interpret this according to ASCII code into binary bytes, which are then sent on to the computer. When the computer completes its operation, it sends a series of bytes back to the teletype, which interprets them according to the ASCII code and causes the appropriate keys to strike. Some bytes correspond to functions other than key strikes -- carriage shift, carriage return, etc.

The POLY 88 uses a keyboard input and video output. (There is also a tape input/output. The tape can be recorded according to the

ASCII code -- actually in a dual-tone code corresponding to the binary representations of the ASCII characters.) The human types into the keyboard his/her input. The keyboard sends this input on to the computer in the form of the bytes assigned to each key by ASCII. When the computer finishes its operations, it sends the information in ASCII to its own video electronics, where the information is converted into the form that will cause the appropriate characters to appear on the screen. You will find a chart showing the ASCII-to-binary code in the appendix.

2. Computer Languages

a. Machine language

As said earlier, the data a computer deals with exist in the form of states of sets of bi-stable devices. Actually, not only data items but also every operation the computer can perform corresponds to a binary number. At the most fundamental level of the computer hardware, events take place in the form of changes in the state of individual devices having two stable states. Therefore, binary "statements" can exactly "express" what is actually happening inside the computer.

The heart of a computer is its central processor, usually consisting of one or more integrated circuits or "chips." Built into the physical structure of these chips are microscopic pathways and electronic devices that enable the computer to perform its basic operations. The POLY 88 has one such chip, the Intel 8080A microprocessor, designed to allow the computer to perform 72 fundamental types of functions. These functions are called "machine instructions," and together are called the instruction set. Each instruction corresponds to a binary number, and the set of all such numbers is called the machine language.

b. Assembly language

Binary exists for the convenience of the computer -- it allows computer design to be as simple as possible. Hexadecimal and ASCII are ways that statements which make sense to the human can

be related to "statements" that "make sense" to the computer. Assembly language is a convenience to the human -- it expresses computer operations in a form that makes sense to him.

Assembly language assigns a word to each instruction. When the human writes a program, he/she uses assembly language to express what the computer is supposed to do. For instance, the human may write down something like this:

INR A

This instruction, which means "INcrement Register A," causes the value stored in a certain location to increase by 1. This instruction can now be converted into a form the computer can use. Each word in assembly language can also be expressed as a two-digit hex number (called the "opcode") which represents the binary instruction actually executed by the machine. (For a list of all assembly language words--the instruction set--and their hex equivalents, see the appendix.) The human can now rewrite his program in hex. The instruction above, for instance, would be:

| HEX | ASSEMBLY LANGUAGE |
|-----|-------------------|
| 3C | INR A |

This conversion process is called assembling. Now we can type our hex directly into the keyboard. From there on, the POLY 88 converts the input into the binary form it requires.

Assembling by hand, by the way, can be avoided. You can program the computer so that it will convert assembly language to the form it needs. Such a program is called an assembler. When using an assembler, you begin by putting the assembler program into the computer. Then you type assembly language directly into the keyboard, and the computer interprets that input appropriately.

c. High level languages

There is an even more "human" way to write a program. Operations which seem to the human to be single steps (like "multiply") may actually require the computer to obey many instructions. The human may find it convenient to be able to use symbols that do not correspond directly to machine instructions. In assembly language there is a word or symbol corresponding to every instruction that the computer will obey in performing its operations. In a high level language, on the other hand, one word or symbol may imply many instructions.

When you write your commands for the computer in assembly language (and then convert them to hex, or enter them directly into the computer by using an assembler), you are thinking in terms of the actual instructions built into the computer's central processor, and so you will probably be making the best use of the abilities of that particular computer. Nevertheless, it can sometimes be a great convenience to be able to write a program in a high-level language, using terms like "multiply" that imply many different instructions and would have to be expressed in several assembly language terms. The high-level language most appropriate for small computers like the POLY 88 is called BASIC. To communicate with your computer in BASIC, you would first program it to convert your statements in BASIC into the appropriate sequence of machine instructions.

3. Computer Theory

a. Address and Memory

Any computer works by performing a series of manipulations (or "program") on data stored in the computer's memory. Computer memory consists of the state of the thousands or millions of small, solid-state "flip-flops" or bi-stable devices within it. The POLY 88 has from 10,000 to half a million such individual devices in its memory, depending on options.

To perform its functions, the computer must be able to locate any one of the data items stored in its memory whenever it is needed. So the computer must keep track of where it puts each item. To do so, it assigns an "address" to each item in memory. In the POLY 88, the memory "bits" (each one corresponding to the state of a single flip-flop) are divided up into bytes of eight bits each, each byte having its own address. To get to a given address, the computer searches along a wiring pathway that has sixteen decision points -- sixteen places where the path can fork to the left or right. A schematic of this pathway would look, in part, like this:

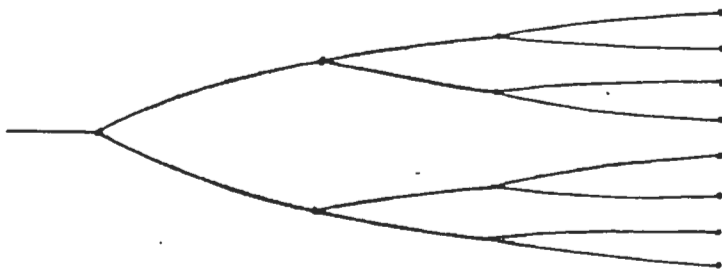

We can assign the binary digits 0 and 1 to left and right turns at each decision point. Consider the pathway represented by the unbroken line:

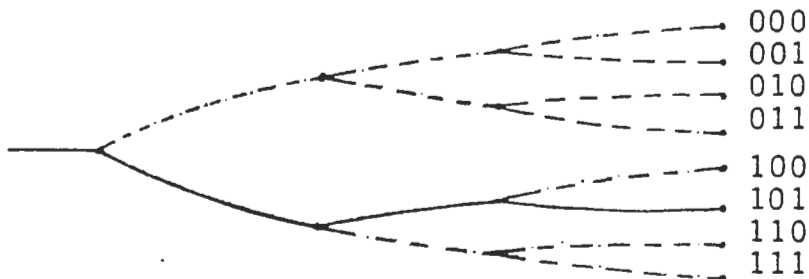

To follow this pathway, you turn first right, then left, then right. Defining left as 0 and right as 1, we can give this pathway the unique name 101, which means "right-left-right." Three right turns would be 111; the pathway involving three left turns would be 000. All the other pathways would have the designations shown. These binary numbers can be thought of as the "addresses" to which these pathways lead. Since we have

either a left or a right turn at each of these decision points, we have a total of 2^3 or eight unique pathways in all. You might have noticed something else interesting. The addresses also turn out to number the pathways in sequence in binary notation. The top one, 000, equals zero. The next one down equals one, the next one is two, the next one is three, and so forth. The last one, 111, is seven. So all eight pathways are neatly numbered, from zero through seven. That is what we mean when we say that each memory address is a unique pathway that can be expressed by a binary number. Each digit, 0 or 1, in the binary number corresponds to the state of a bi-stable device that is serving as a "switch" that turns the pathway to the left or right.

As you can see from the figure above, the total number of different pathways doubles at every decision point. Since there are 16 such points in all in the POLY 88, it can store items in 2^{16} or 65,536 different possible memory locations. Each "location" is actually a unique pathway, determined by the states of sixteen bi-stable devices, leading to a unique set of eight binary devices. The states of these eight devices constitute an item, or part of an item, stored in memory (one byte of memory). So -- 2^{16} or 65,000 possible pathways leading to 65,000 locations, each of which can contain any one of 2^8 or 256 different binary values.

All addressed locations taken together make up the "memory space" of a computer. Any one address is sometimes called a "vector" in this space because it "points" to a single byte in memory. The memory space and address pointer can be depicted like this:

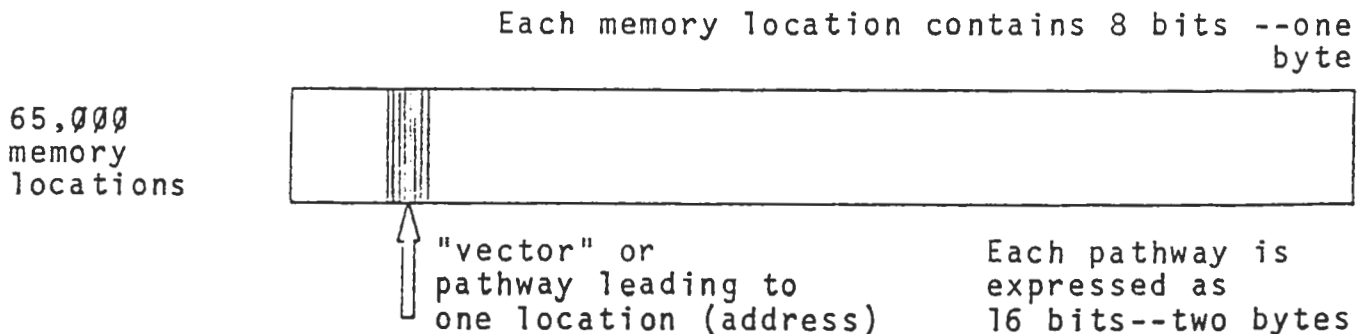

with the bar representing the bytes of 8-bit groups within the memory, and the large arrow indicating the 16-bit address that specifies the pathway leading to each memory location.

The items stored in memory can be used in any one of several ways. An item can represent a program instruction to the machine. Bytes in memory can represent ASCII characters, and thus can enable the machine to communicate with its human operator. An item can be a numerical value, to be manipulated in a program--like your bank balance. In the same way, a pathway leading to these items can be defined in two ways: as a program pointer (called "program counter") when it leads to memory items defined to be instructions; or as a data pointer when it leads to quantities to be manipulated by the program. Whether a certain stored item is to be considered an instruction or a quantity to be manipulated by a program is up to the operator. The computer does not care either way. In fact, if the operator accidentally tells the computer to treat a data quantity as though it were an instruction, the computer will gladly do so. To it, anything the program counter points to is an instruction--whether the operator meant it to be an instruction or not. And anything the data pointer points to is an item of data to be manipulated. Trouble sometimes occurs when the operator accidentally causes the program counter to point to a memory location that does not contain program. The computer executes the item as an instruction, and from that point begins to produce nonsense or "garbage."

b. Central Processor Architecture

A computer consists of memory space, containing stored program instructions and data to be manipulated in programs, and a central processing unit, which manipulates data in response to program instructions. The CPU opens pathways to memory items, takes items from memory and temporarily stores them, transforms data by means of mathematical and logical operations, and sends results out to memory or to an output device.

The organization of a processor is called its "architecture; an extremely simple computer could work like this:

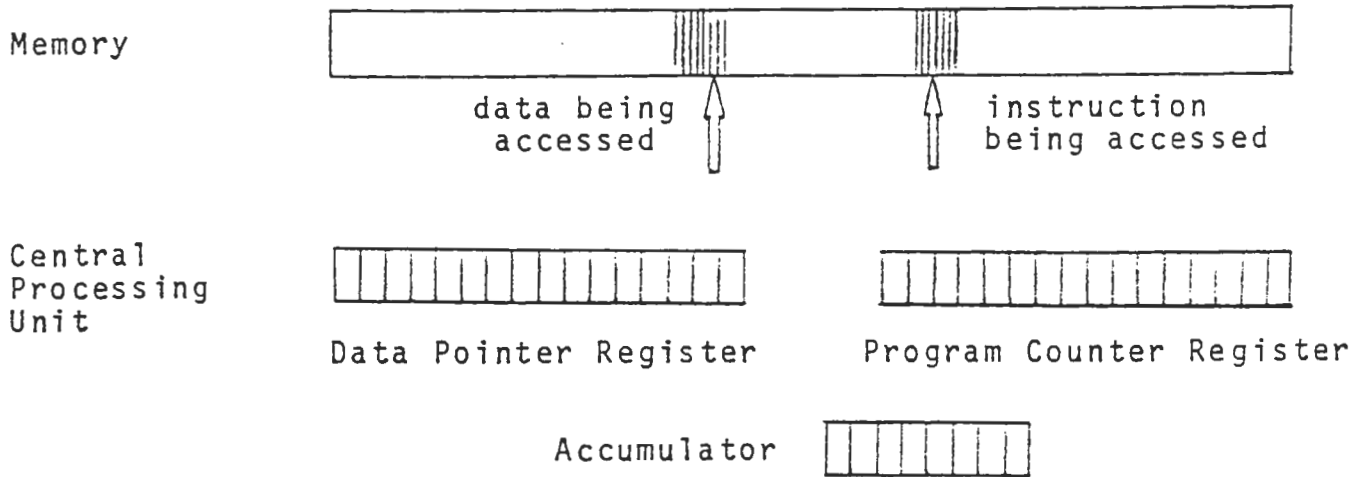

Here we have a bar representing a large amount of memory, with a data pointer pointing to a quantity stored at one address, and a program counter pointing to a program instruction which tells the CPU what to do. (Don't lose sight of the fact that these "arrows" that are "pointing" at bytes of memory are actually pathways leading to groups of eight bi-stable devices.) Also, there are some "registers." The data pointer register contains the two-byte number that corresponds to the memory address the data pointer is pointing to. The program counter register states the memory address of the instruction that the CPU is currently executing. This hypothetical computer performs the operation pointed to by the program counter, using the data pointed to by the data pointer. The result of the operation gets stored in the accumulator. Note that, because the data pointer and program counter registers hold addresses, they contain two bytes. When the computer finishes the operation indicated by the program counter, the program counter automatically moves to the next instruction in the program. The program counter may "jump" on command to a new address at a considerable distance from the previous location, but for one moment let's visualize it as just moving one slot to the right at each step. The

computer then does whatever that instruction tells it to do. Each time an instruction is completed, the program counter moves to its next instruction.

The operation of this simple computer can be visualized as follows. The program counter points to an instruction that tells the CPU, "Move data pointer to <address> ." The CPU opens a line to the slot bearing that address. It also move the program counter to the next instruction. The next instruction says, "Take the quantity located in the slot indicated by the data pointer, and move it to the accumulator." The CPU does so. Next instruction: "Move the data pointer to <new address> ." CPU obeys. "Add the quantity in that slot to the quantity in the accumulator." CPU does this. "Move the data pointer to <new address> ." Obeys. "Take the quantity from the accumulator and put it in the memory slot that the data pointer is now pointing to."

Note that this series of operations involves three quantities in memory: two quantities that were already in memory, and a third quantity, the sum of the first two, which is now also stored in memory.

Now, about those other two CPU registers. Every time the computer obeyed an instruction, the program counter register changed to reflect the address of the next instruction. Since we are visualizing this simple computer as performing a series of instructions in sequence, let us say for the moment that after each instruction is performed, the value in the program counter register goes up by 1, to move the program counter one slot up. (Actual instructions can consist of several bytes and therefore occupy several consecutive addresses.) We could put an instruction into the program that says "Jump the program counter all the way to another part of the program." The value stored

in the program counter register would change to reflect the address of the new instruction. The same thing is true of the data pointer register -- the value in the data pointer register goes up or down as the data pointer moves to correspond to the memory address of each accessed memory item.

Why the accumulator? Because a computer performs its operations by taking one very small step at a time. To take a quantity out of memory, then take another one from memory and add it to the first, then put the sum into a new location, takes the computer three steps. It needs the accumulator to store the results of intermediate steps.

This simple computer can do anything that any real computer can do. But because it has just the three basic registers, it does everything slowly. To increase the speed of the computer, we add registers.

The POLY 88 has several additional "working registers." The working registers are like the accumulator in that they temporarily store values being used in computations.

We will add the working registers to our conceptual depiction of what is called the architecture of the POLY 88:

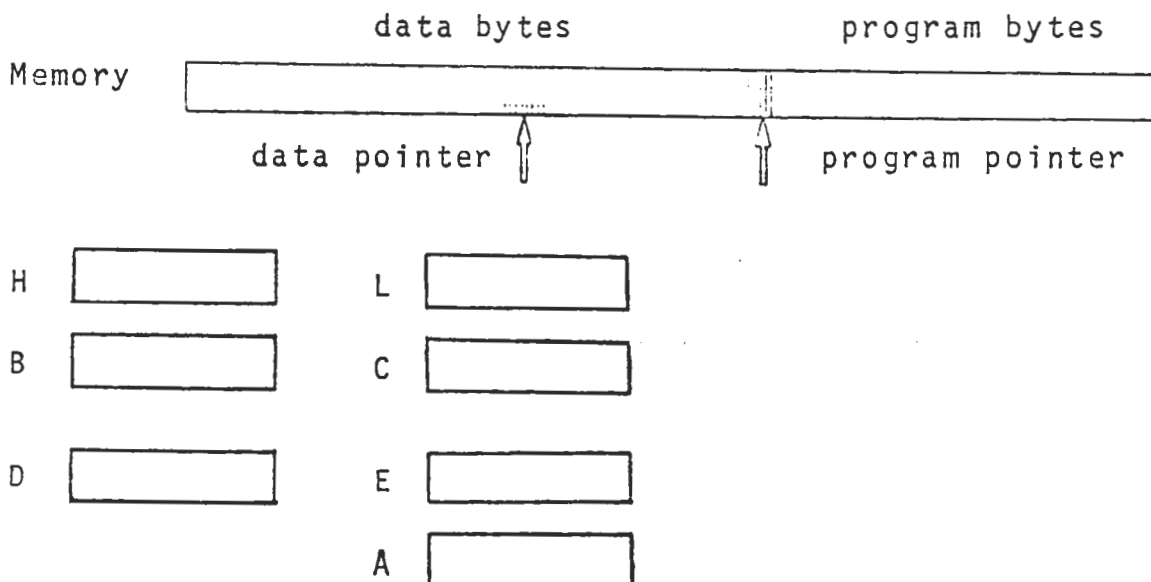

So far, we have the memory space; a data pointer register; a program counter register; working registers (two pairs, each one holding one byte); and an accumulator. Let us consider the working registers.

The working registers, like the accumulator, temporarily store values the computer is using in the course of its operations. Thus the computer can move a value from memory to any register, including the accumulator, from any register to any other register, and from any register to memory. It can perform some operations on the contents of the accumulator. It can also perform operations involving the contents of the accumulator and other registers (add them, for instance).

You have probably noticed that, because we used the letter A to designate the accumulator, we designate the working registers B, C, D and E. Each register holds one byte; the registers can also be used in pairs, B with C and D with E, to hold 16 bit quantities. The register pairs are called "pair B" and "pair D."

You might also note that we are using the letters H and L to designate the two bytes of the datapointer register pair. This simply means that the left register contains digits of relatively high significance, the right register digits of lower significance. In any number, the significance of digits increases as you move to the left -- in decimal, tens are more significant than ones, hundreds are more significant than tens, and so forth. The letters H and L could apply to any of the register pairs; by convention, however, only this register pair is described in that way.

There remains just one basic feature of computer architecture to add: the stack pointer. In order to talk about the stack pointer, we will have to go a bit deeper into the subject of programming.

A program is a pre-determined series of instructions for the

computer to follow in solving a specific problem. Recall that the heart of the computer is its central processing unit, consisting of one or more chips into which are built the electronics providing for all the logical operations of the computer. This central processor lets the computer deal with all the various kinds of problems it is built to deal with. But the central processor does not tell the computer when to perform any given operation, or on what, and so it does not enable the computer to deal with any specific problem. That requires a program.

The fundamental instructions built into the central processor are called collectively the "instruction set." A program also consists of instructions, which the user stores in memory. The computer uses the electronics of the central processor as required to obey the program instructions it encounters in memory.

A very simple program starts out with instruction #1 and moves along in a straight line through a series of instructions to the end. But almost no program is that simple. Most programs incorporate strings of instructions that the computer performs repeatedly, returning to the beginning of the string and performing it again until some condition is satisfied. These repeating strings are called "loops."

Another possibility is a separate part of a program that performs some specific task that may be called for at several different times in the execution of the program. The computer moves to that part of the program whenever it is instructed to, and performs the instructions it contains; then it returns to the main-stream program. These repeatable sub-portions of the program are called "sub-routines."

Obviously, the terms "loop" and "sub-routine" are not really mutually exclusive. A sub-routine could be a loop. The point is that both terms indicate a departure from the straight-ahead, left-foot-right-foot progress of the program.

We can depict a sub-routine in this way:

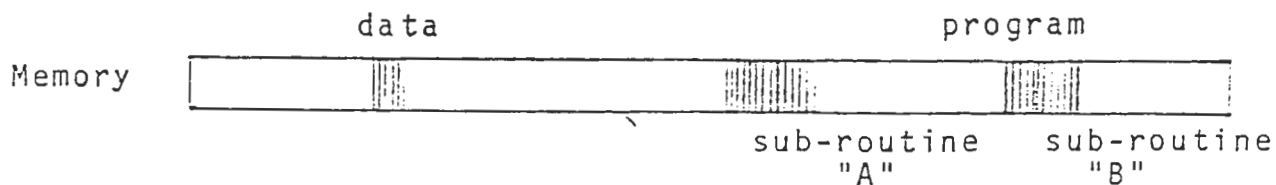

Sub-routines "A" and "B" consist of instructions for operations that are needed several times in the execution of the program. Every time sub-routine "A" is needed, the computer comes upon the instruction "Call sub-routine <first address in A> ." And off it goes. When it needs "B," the computer comes upon the instruction "Call sub-routine <first address in "B"> ."

This is where the stack pointer comes in. Say the program counter departs from the main-stream program and goes to sub-routine "A." The computer performs the sub-routine as required. Now it has to get back to the right place in the main program. The stack pointer records the address to which the program counter must return in order to resume the main-stream program. In the example we are discussing, this will be the address in the main-stream from which the program counter originally departed -- plus three.

Why plus three? Because if the program counter returned from sub-routine "A" to exactly the same point in the program from which it departed, it would once again come upon the instruction "Call first address in "A" ." So back it would go to the beginning of sub-routine "A". Finished, it would return to the same instruction -- and go back to "A" again -- and again -- till some merciful human pulled the plug. So when it return from the subroutine, it must begin at the instruction following the "CALL" (one-byte) and the two-byte address of the sub-routine.

Now, our example is still very simple. So far it just involves jumping to either "A" or "B" from the main-stream program, then

back. But often a program will involve calling a sub-routine, then calling from the midst of the sub-routine to another, and so forth. So the program counter may move from the main-stream program to "A," then before finishing "A" it may move to "B," then "C," etc. To return, it may have to go from "C" to "B," then to "A," then back to the main-stream program. The actual path a computer follows to go from question to answer can be very, very complicated.

That is why the stack pointer has a stack. The stack pointer keeps inserting into a portion of memory the addresses that the program counter has to return to as it finishes with sub-routines. The first address that goes into this "stack" is the address from which the program counter departed when it jumped to sub-routine "A," plus three. If it goes to "B" before it finishes with "A," then the next entry in the stack is the address in "A" to which the program counter must eventually return. The stack pointer keeps putting these addresses in, in the required order, till it is necessary to start returning.

To summarize, the computer stores into its memory both data items and program instructions, in the form of bytes. It takes data items from memory and puts them into the working registers, where they can be manipulated. Addresses, or pathways leading to data bytes and program bytes, are represented in the program counter, data pointer, and stack pointer registers. These addresses can themselves be stored into memory and recalled as required.

c. Instruction Set

At the heart of the POLY 88 is a small "chip," about the size of the nail of your little finger, called a central processing unit or CPU. This integrated circuit, the Intel 8080 A, incorporates many microscopically small solid-state electronic devices that enable the computer to perform its various operations. Basically, in fact, all processing is the job of the CPU, while the rest of the computer components provide input, output, storage, and access.

We will now take a look at all 72 kinds of operations or "instructions" the Intel 8080 CPU can perform. First we will consider some general concepts.

Some of the operations the CPU performs are familiar -- addition and subtraction, for instance. Others equally important, and in fact more fundamental, are "logical operations," in particular those called complementation, AND, OR, and XOR (exclusive OR).

COMPLEMENTATION

Addition and subtraction treat binary quantities as quantities -- as numbers built up of one or more digits, to be treated as wholes. Logical operations, on the other hand, treat the bits of binary values one at a time. One of them, complementation, simply changes every 0 to a 1 and every 1 to a 0. These two numbers are complementary:

```

10101000
01010111
    
```

One of the CPU's operations is "complement"--that is, the CPU can be told to complement any number, and will respond by changing every 0 to a 1 and every 1 to a 0.

TWOS COMPLEMENT

For simplicity of design, the central processor uses addition to subtract. It does this by converting a number to be subtracted into its "twos complement," which in effect reverses its sign, then adding it to the number to be subtracted from.

Let's say that the subtraction problem is:

```

  11011001
- 01001001
-----
    
```

The number to be subtracted is 01001001. To do this, we will instead add the twos complement of this number, which is in effect its negative counterpart (in a number of fixed length--here, eight bits). We begin by constructing its twos complement.

First we complement this number -- invert every bit. It becomes 10110110. That is the "ones complement," or just the complement of 01001001. Then we add 1 to give the twos complement.

$$\begin{array}{r} 10110110 \\ + 00000001 \\ \hline 10110111 \end{array}$$

We can test to see if this is really, in effect, the negative equivalent of the original number by adding it to the original number and seeing if the result is zero. In so doing, we will also see the point of considering only numbers of fixed length.

$$\begin{array}{r} 01001001 \\ + 10110111 \\ \hline 10000000 \end{array}$$

ninth bit
not considered
part of sum

one byte

The fact that we are considering numbers of fixed length means that the carry out of the most significant place is not considered part of the sum, so zero can result from the addition of two nonzero bytes.

Adding 10110111 to 11011001 yields:

$$\begin{array}{r} 11011001 \\ + 10110111 \\ \hline 10010000 \end{array}$$

Carry not
part of sum

result

Among binary number of a fixed length of eight bits, there are 256 different possible combinations. These 256 combinations can be considered to be the positive numbers from 0 through 255. Equally well, they can be considered the 256 values from -128 to +127. In this latter case, the binary expressions for the values from 0 to +127 would all be exactly the same as when only

positive numbers are being represented. Then converting all of these values to their twos complements yields the remaining binary values which can be considered their negative counterparts. Note that, in this case, all the positive numbers would begin with a 0 in the most significant place, and all the negative numbers would begin with a 1.

$$\begin{aligned} 00000001B &= 1 \\ 01111111B &= 127 \text{ (decimal)} \end{aligned}$$

$$\begin{aligned} 11111111B &= -1 \text{ (twos complement of 1)} \\ 10000001B &= -127 \text{ (twos complement of 127D)} \end{aligned}$$

Note that 0 (00000000B) and -128 (10000000B) are their own twos complements. All other values have their own unique but dissimilar twos complement.

The existence of these two sets of values, positive values starting in every case with a 0 and negative values starting in every case with a 1, means that the most significant bit can be considered not only part of the value but also the sign of the value. This is called "signed twos complement notation." The following discussion of computer operations or "instructions" must be understood in light of twos complement representation.

LOGICAL OPERATIONS

One logical operation, complementation, treats the bits of a single binary value. The other logical operations of the CPU compare the bits of one binary number with the bits of another. Let's take two binary numbers having just one bit each:

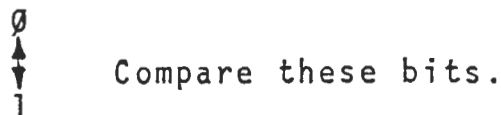

The comparison checks to see if the two bits conform to some "rule," and leaves a record to indicate whether or not they do conform. A rule might be: "The two bits are the same." If they are the same, we can leave a 1 as a record; if they are not the same, we can leave a \emptyset . Note that, in a comparison of two bits, the first bit can be either a \emptyset or a one, and the second bit can also be a \emptyset or a 1, so there are 2^2 or four possible cases:

| | | |
|---|---|---------------|
| $\emptyset \longleftrightarrow \emptyset$ | : | 1. |
| $1 \longleftrightarrow 1$ | : | 1. |
| $1 \longleftrightarrow \emptyset$ | : | \emptyset . |
| $\emptyset \longleftrightarrow 1$ | : | \emptyset . |

(Since the rule says nothing about the order of the bits, we can consider the last two cases identical.)

A different rule will produce different results for the same cases. Supposing the rule is "One or the other of the two digits is a 1." Now the four cases produce:

| | | |
|---|---|---------------|
| $\emptyset \longleftrightarrow \emptyset$ | : | \emptyset . |
| $1 \longleftrightarrow 1$ | : | 1. |
| $1 \longleftrightarrow \emptyset$ | : | 1. |
| $\emptyset \longleftrightarrow 1$ | : | 1. |

Another way of saying that two bits compare in conformance with a rule is that the comparison is true. Using false and true instead of \emptyset and 1 is very interesting, because it shows how fundamental these comparisons are to logic, and therefore why these comparisons are called logical functions.

In the second example above, the rule was that one or the other

of the two bits (or both) had to be 1. If at least one bit was 1, the result of the comparison was also 1. If neither was 1, the result of the comparison was \emptyset . Defining \emptyset as false and 1 as true, we can restate that rule thus: If one bit or the other is true, then the result is also true. For brevity:

If A is true OR B is true, then
C is true.

This rule provides a model for a certain kind of logical syllogism -- the kind in which a certain conclusion always follows if either one of two conditions is met. For instance:

If the batteries are dead, OR the bulb is burned out, the flashlight will not work.

Here, either one of the conditions if true is sufficient to make the conclusion true. There is, of course, another kind of relationship; in which both one condition AND the second must be true for the result to be true.

If you have enough money, AND if the store is open, you can buy what you want.

This AND relationship provides the model for the most famous syllogism of all: "All men are mortal; Socrates is a man; therefore Socrates is mortal." Stated like the previous example: "If all men are mortal, AND if Socrates is a man, then Socrates is mortal." Note that syllogisms need not assert the truth of any particular fact, but only offer a model to predict the "truth relationships" of possibilities. Another way of making the same syllogism would be:

All men mortal? True. AND Socrates a man? True: Socrates mortal?
True.

To summarize the AND relationship:

false AND false: false
 false AND true : false
 true AND false: false
 true AND true : true

Defining 0 as false and 1 as true, we can summarize the AND relationship in this "truth table":

| | | | |
|---|---|---|-----|
| | 0 | 1 | |
| 0 | 0 | 0 | AND |
| 1 | 0 | 1 | |

We have already seen the rule that if one OR the other (or both) of the two conditions being compared is true, then the result is true. Here is the OR truth table:

| | | | |
|---|---|---|----|
| | 0 | 1 | |
| 0 | 0 | 1 | OR |
| 1 | 1 | 1 | |

One other rule concerns us here: The XOR or "exclusive OR" rule, in which one or the other (but not both) conditions must be true for the result to be true.

For instance, suppose that Mr. Smith employs an equal number of female and male people:

If Smith hires one female, XOR if Smith hires one male, he will have an unequal number of female and male employees.

Here is the XOR truth table:

| | | | |
|---|---|---|-----|
| | 0 | 1 | |
| 0 | 0 | 1 | XOR |
| 1 | 1 | 0 | |

As we said before, the POLY 88 CPU compares the bits of two numbers by means of one of these rules in performing its logical operations. Here's how two numbers are compared in these ways:

$$\begin{array}{r} \text{result} \quad 10110010 \\ \quad \quad \quad 11011111 \\ \hline \quad \quad \quad 10010010 \end{array} \quad \text{AND}$$

The top number is compared bit by bit with the number below it, to see if the upper bit AND the lower bit are 1.

$$\begin{array}{r} 10110010 \\ 11011111 \\ \hline 11111111 \end{array} \quad \text{OR}$$

The top number is compared bit by bit with the number below it, to see if the upper bit OR the lower bit is 1.

$$\begin{array}{r} 10110010 \\ 11011111 \\ \hline 01101101 \end{array} \quad \text{XOR}$$

The top number is compared bit by bit with the number below it, to see if the upper bit XOR the lower bit is 1.

BRANCHING

Computers are valuable primarily because they can do repetitive tasks very rapidly. To be able to repeat the same task a required number of times, the computer must be able to decide whether it is to repeat a task or move on. The computer repeats a task

until some condition is satisfied, then moves on to something else. If it could not make such a decision, the computer would have to be told whether to repeat or move on -- the operator would have to make that decision, and the computer would be far less useful than it is.

This decision can be -- and is -- divided into two parts: a test and a branch. The test determines which of two conditions exists. The test may be of whether two values are equal, or of whether one value is at least as large as another; it may be of whether a particular single bit is 0 or 1, etc. These tests always involve at least one of the values currently stored in a CPU register.

The branch is the point at which the computer moves in one of two directions. Which way the computer goes depends on the result of a previous test. We need a way to record the results of the test for use in the branch. This the computer does by setting the value of a particular bit to 1 or resetting it to 0 to indicate which of two conditions was found to exist. These bits are called "flags."

These decisions, called conditional branches, always involve two instructions:

TEST. Which of two conditions exists? Set a particular flag to 1 or reset it to 0 depending on which condition exists.

BRANCH. Is a particular flag 0 or 1? Go on to one or another of two different instructions depending on the status of the flag.

Following a branch instruction, the computer always moves on either to the next instruction in sequence, or to an address stated in the branch instruction itself, where it will encounter another instruction.

In the POLY 88 there are five flags.

CARRY FLAG

When a number is added to the value in the accumulator, the result may include a carry out of the left-hand bit, the bit of highest significance. This carry "sets" the carry flag to 1.



accumulator

When an addition does not result in a carry out of the most significant accumulator bit, the carry flag is 0.

The carry flag can be set to 0 or 1 by other operations. For instance, the instructions RAR (rotate accumulator right) and RAL (rotate accumulator left) affect the carry flag. In RAR, the least significant bit in the accumulator moves into carry, the bit that was in carry goes into the most significant place in the accumulator, and all other accumulator bits move one place to the right.



RAL is the opposite of RAR.

The carry flag can be affected by logical operations as well as addition, subtraction, and rotation.

AUXILIARY CARRY FLAG

A carry out of the "third bit" (fourth place -- 2^3) sets the auxiliary carry flag:

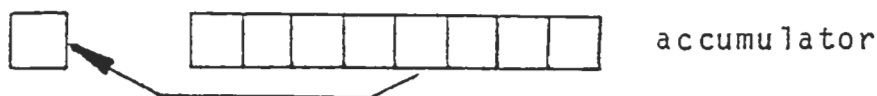

The auxiliary carry flag cannot be tested directly, and exists only to enable the DAA instruction for decimal conversion.

SIGN FLAG

The sign flag is set by certain instructions to duplicate the most significant bit of the value in the affected register.



Recall from our discussion of twos complement that the most significant bit in a register can be interpreted as the sign of the data quantity when the quantity is considered to be twos complement.

ZERO FLAG

The zero flag is set to 1 at the end of certain operations if the byte resulting from the operations is all zeroes; the zero bit is reset to 0 if the result is not zero.

A result that consists of eight zeroes plus a carry out of the seventh bit sets the zero flag to 1, and also sets the carry flag to 1.

PARITY FLAG

"Parity" refers to whether the number of 1s in a byte is even or odd. Byte parity is checked after certain operations. If the

number is even, parity is "even" and the parity flag is set to 1; if there is an odd number of 1s, parity is "odd" and the parity flag is reset to 0.

INSTRUCTIONS

Following is a complete list with discussion of all the operations built into the central processor of the POLY 88. The discussion divides the operations into groups of related instructions. Each operation is identified by a "mnemonic" which corresponds to an instruction in machine language ("opcode"). For a chart showing all assembly mnemonics and the associated opcodes, see appendix.

CARRY FLAG INSTRUCTIONS. Two instructions affect the carry flag alone:

CMC (complement carry). Complement the carry flag -- Set it to 0 if it is 1 or to 1 if it is 0.

STC (set carry). Set the carry bit to 1.

SINGLE REGISTER INSTRUCTIONS. These instructions affect the contents of one memory address or any one of the CPU registers -- one byte. If memory, the instruction affects the byte addressed by pair H.

INR (increment register or memory). Increment the affected register or memory byte by 1 -- add 1 to it.

DCR (decrement register or memory). Decrement register or memory byte by 1. This instruction is the opposite of INR -- it is identical to it except that it reduces the affected byte by 1. All flags may be affected.

CMA (complement accumulator). Complement the byte in the accumulator -- change every 1 to 0 and 0 to 1. No flags are affected.

DAA (decimal adjust accumulator). Adjust the byte in the accumulator to form two groups of four bits, each representing one decimal digit. This instruction is rather complicated, treating as it does the awkward relationship between binary and decimal. It is used -- infrequently -- when a decimal output is desired. DAA adjusts the first four bits and second four bits of the accumulator byte separately. First, the less significant four bits of the accumulator byte are compared to 1001 to see if they are greater than nine. If they are (or if the auxiliary carry flag is set to 1), then the accumulator is incremented by six -- which reduces the value of the four bits to nine or less. Next, if the four more significant bits of the accumulator byte now represent a number greater than nine (or if the carry flag is set to 1), then these four bits are incremented by six, so that they will represent a value of nine or less. Note that either of these two adjustments may have produced a carry. A carry out of the four less significant bits sets the auxiliary carry flag to 1; otherwise, it is reset. A carry out of the accumulator byte sets the carry flag to 1; otherwise, it retains its previous value. All other flags may be affected.

NO-OPERATION INSTRUCTION:

One instruction results in no operation.

NOP (no operation). Move on to the next instruction in sequence. No flags are affected.

DATA TRANSFER INSTRUCTIONS:.....

These instructions transfer data between registers or between memory and registers.

MOV (move). Move one byte of data from an indicated register or memory to another individual register or memory. The data also remains in its original location.

Format example: MOV B,A. "Move the byte in A (accumulator) into register B." Note that the format states the affected register first. Data cannot be moved from one memory address to another in a single operation. Data moved out of memory is always taken from the location addressed by H & L. No flags are affected.

STAX (store accumulator). Store the contents of the accumulator into the memory location addressed by register pair B or pair D. No flags are affected.

LDAX (load accumulator). Store the contents of the memory location addressed by the indicated register pair (pair B or pair D) into the accumulator. No flags are affected.

REGISTER OR MEMORY TO ACCUMULATOR INSTRUCTIONS.

These instructions operate on the accumulator using a byte taken from a register or from memory. Memory is taken from the memory location addressed by the data pointer (H & L). Results are left in the accumulator.

ADD (add register or memory to accumulator). Add the byte in one register or in memory to the value in the accumulator. ADD A doubles the accumulator. All flags may be affected.

ADC (add register or memory and carry flag bit to accumulator). Add the byte from a specified location, plus the value of the carry flag, to the value in the accumulator. All flags may be affected.

SUB (subtract register or memory from accumulator). Subtract the byte in a specified register or memory location from the value in the accumulator. SUB A subtracts the accumulator from itself, leaving it (and the carry flag) at zero. All flags may be affected.

SBB (subtract register or memory and carry flag bit -- "borrow"-- from accumulator). Subtract the byte taken from a specified location, plus the value of the carry flag, from the accumulator. All flags may be affected.

ANA (AND register or memory with accumulator). AND the specified byte with the accumulator. ANA is often used to zero part of the accumulator. Carry, zero, sign, and parity flags may be affected.

XRA (XOR register or memory with accumulator). XOR the specified byte with the value in the accumulator. XRA A zeroes the accumulator. Then a MOV from A to a register zeroes that register. All flags may be affected.

ORA (OR register or memory with accumulator). OR the specified byte with the value in the accumulator. This instruction is often used to set part of the accumulator to 1s. Flags affected: carry flag is zeroed; zero, sign, and parity flags may be affected.

CMP (compare register or memory with accumulator). Compare the specified byte to the contents of the accumulator. In effect, this determines if the specified byte is smaller than, equal to, or larger than the accumulator byte. Flags: the zero flag is 1 if the quantities are equal, and 0 if they are unequal. The carry flag is 1 if the register or memory byte is larger than the accumulator byte, and 0 otherwise (but when the two compared values differ in sign, the sense of the carry flag is reversed). All other flags may also be affected.

ROTATE ACCUMULATOR INSTRUCTIONS.

These instructions rotate the contents of the accumulator -- move a bit from one end, and shift the other bits one place. Rotation can be to the left or to the right, and involves the carry flag bit (but no other).

RLC (rotate accumulator left and into carry). Move the most significant bit in the accumulator (left-hand bit) into the carry flag and into the least significant place in the accumulator. All other bits shift one place to the left.

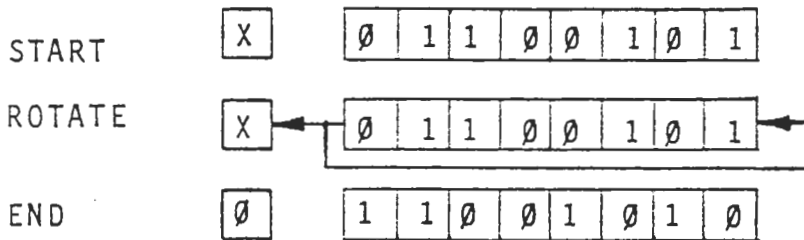

RRC (rotate accumulator right and into carry). Here, move the least significant bit from the accumulator into carry and into the most significant place; the opposite of the instruction above.

RAL (rotate accumulator left, through carry). Move the most significant accumulator bit into carry, and the carry flag bit into the least significant place; shift all other accumulator bits left.

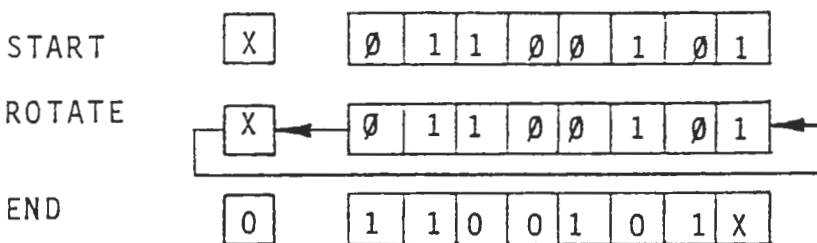

RAR (rotate accumulator right, through carry). Move the least significant bit to carry, and move carry into the most significant place; the opposite of the instruction above.

REGISTER PAIR INSTRUCTIONS.

These instructions operate on the register pairs.

PUSH (push data onto stack). Store the value in the specified register pair into the two bytes of memory addressed by the stack pointer. Such data is said to be "pushed" onto "the stack." The more significant byte goes into address SP-1, the less significant into address SP-2. Indicating PSW (processor status word) stores the current accumulator value at SP-1 and a byte incorporating all the flags in SP-2:

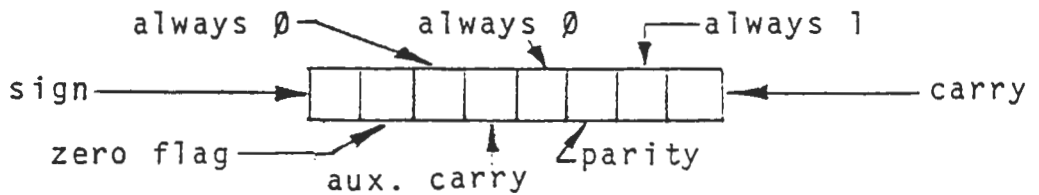

The stack pointer is left pointing to the address where the second byte has been stored. Flags are not affected.

POP (pop data off stack). Store data from the stack into the indicated register pair. The byte of data at SP is stored into the less significant register; the byte at SP+1 goes into the more significant register. If register pair PSW is indicated, the byte at SP goes into the accumulator, and the byte at SP+1 provides the bits of the flags. This instruction is the opposite of the one above.

DAD (double add). Add the two-byte value in the indicated register pair (B, D, or H) to the two-byte value in pair H, and leave the result in pair H. Flag affected: carry.

INX (increment extended register pair). Increment the value in a register pair by 1 -- add 1 to it. No flags are affected.

DCX (decrement extended register pair). The opposite of the above.

XCHG (exchange registers). Move the value in pair H to pair D and vice versa. No flags are affected.

XTHL (exchange H & L with stack). Exchange the value in L with the value in the memory location addressed by the stack pointer and exchange the value in H with the value in that memory address plus one (SP + 1). No flags are affected.

SPHL (load SP from H & L). Load the value in register pair H into the stack pointer register. That value is now the stack address pointed to by the stack pointer. No flags are affected.

IMMEDIATE INSTRUCTIONS.

These instructions operate on one or two bytes of data, included in the instruction itself. The data immediately follows the opcode (hence "immediate").

LXI (load extended immediate). Load the indicated register pair with the two bytes immediately following. The first byte goes into the lower-order register, the second into the higher-order register. No flags are affected.

MVI (move immediate). Move the following byte into the specified register or into the memory location addressed by the data pointer. This instruction resembles LXI except that it enters only one byte of data (and therefore can be used to load a memory location).

No flags are affected.

ADI (add immediate to accumulator). Add the following byte to the value in the accumulator, and leave the result in the accumulator. All flags may be affected.

ACI (add immediate, plus the carry bit, to accumulator). Add the following byte, plus the value of the carry flag bit, to the value in the accumulator, and leave the result in the

accumulator. All flags may be affected.

SUI (subtract immediate from accumulator). Subtract the following byte from the value in the accumulator, and leave the result in the accumulator. All flags may be affected. This instruction is the subtraction equivalent of ADI above.

SBI (subtract immediate, and "borrow," from accumulator).

Subtract the byte immediately following, and the value of the carry flag bit, from the value in the accumulator, and leave the result in the accumulator. This is the subtraction equivalent of ACI above. All flags may be affected.

ANI (AND immediate with accumulator.) AND the byte immediately following with the value in the accumulator, and leave the result in the accumulator. Carry, zero, sign, and parity flags may be affected.

XRI (XOR immediate with accumulator). XOR the byte immediately following with the value in the accumulator, and leave the result in the accumulator. The carry flag is set to 0. Zero, sign, and parity flags may also be affected.

ORI (OR immediate with accumulator). OR the byte immediately following with the value in the accumulator, and leave the result in the accumulator. The carry flag is set to 0. Zero, sign, and parity flags may also be affected.

CPI (compare immediate data with accumulators). Compare the following byte to the value in the accumulator. The zero flag is set to 1 if the two values are equal and 0 if they are unequal and 0 if they are unequal. The carry flag is set to 1 if the immediate data value is larger than the accumulator value, and set to 0 otherwise. (But if the two values differ in sign, the

sense of the carry flag is reversed.) All other flags may be affected.

DIRECT ADDRESSING INSTRUCTIONS.

These instructions involve the contents of memory addresses; the addresses are included as part of the instruction. The instruction states the address "backwards" -- first the less significant address byte, then the more significant. These instructions do not affect flags.

STA (store accumulator direct). Store the value in the accumulator into the memory location addressed in the instruction.

LDA (load accumulator direct). Load the contents of the memory location addressed in the instruction into the accumulator. No flags are affected. This instruction is the opposite of STA above.

SHLD (store H and L direct). Store the contents of register pair H into the memory location addressed in the instruction. No flags are affected.

LHLD (load accumulator direct). Load the contents of the memory location addressed by the instruction into the L register, and the contents of the next higher address into the H register. This is the opposite of SHLD above.

JUMP INSTRUCTIONS

These instructions cause the computer to "jump" to another part of a program rather than continue to perform instructions in sequence. None of these instructions affects flags.

PCHL (load program counter with H & L). Load the contents of register H into the more significant byte of the program counter, and the contents of register L into the less significant byte. The next instruction executed will be the one now addressed by the program counter. Note that this instruction does not itself contain an address. All other jump instructions do.

JMP (jump). Execute the instruction located at the address given in the instruction, and continue sequentially. This is called an "unconditional jump." All the following jump instructions are "conditional."

JC (jump if carry). Jump to the instruction addressed by this instruction if the carry flag is set to 1. If the carry flag is 0, move on to the next instruction in sequence.

JNC (jump if no carry). Jump to the instruction addressed by this instruction if the carry flag is set to 0. If the carry flag is 1, move on to the next instruction in sequence. This instruction is the opposite of the above.

JZ (jump if zero). Jump to the instruction addressed by this instruction if the zero flag is set to 1. If the zero flag is set to 0, move on to the next instruction in sequence. Compare to JC. Note that "if zero" means that the register in question is all zeroes, so that the zero flag is set to 1.

JNZ (jump if not zero). Jump to the instruction addressed by this instruction if the zero flag is set to 0. If the zero flag is set to 1, move on to the next instruction in sequence. This instruction is the opposite of JZ above. Compare to JNC.

JM (jump if minus). Jump to the instruction addressed by this instruction if the sign flag is set to 1 ("minus"). If the sign flag is set to 0, move on to the next instruction in sequence. Compare to JC and JZ above..

JP (jump if plus). Jump to the instruction addressed by this instruction if the sign flag is set to 0 ("plus.") If the sign

flag is set to 1, move on to the next instruction in sequence. This instruction is the opposite of JM above. Compare to JNC and JNZ.

JPE (jump if parity even). Jump to the instruction addressed by this instruction if the parity flag is set to 1 ("even parity"). If it is set to 0, move on to the next instruction in sequence. Compare to JC, JZ, and JM above.

JPO (jump if parity odd). Jump to the instruction addressed by this instruction if the parity flag is set to 0 ("parity odd"). If the parity flag is 1, move on to the next instruction in sequence. This instruction is the opposite of JPE above. Compare to JNC, JNZ, and JP above.

CALL SUBROUTINE INSTRUCTIONS

Like jump instructions, call instructions cause the computer to depart from sequential execution of instructions. Also like jump instructions, they usually are "conditional" -- they usually operate only if some condition is met. And as with jump instructions, execution of instructions continues in sequence starting with the instruction at the address called (stated in the call instruction). The two types of instructions also resemble one another in that the address included is stated "backwards" -- first the less significant address byte, then the more significant. Also, these instructions do not affect flags.

The two kinds of instructions differ in that a call instruction "pushes" an address onto "the stack" -- namely, the address of the instruction to which the computer will "return" when it has finished the subroutine. See Section A.3. for a discussion of the stack.

CALL. Go to the instruction addressed by this instruction, and begin sequential execution there. This is an "unconditional call,"

and corresponds to an unconditional jump. All other call instructions are conditional, and correspond to the conditional jump instructions, each triggered by the state of one of the flags.

CC (call if carry). Go to the instruction addressed by this instruction if the carry flag is set to 1. If the carry flag is 0, move on to the next instruction in sequence.

CNC (call if no carry). Go to the instruction addressed in this instruction if the carry flag is set to 0. If the carry flag is 1, move on to the next instruction in sequence. This instruction is the opposite of CC above.

CZ (call if zero). Go to the instruction addressed by this instruction if the zero flag is set to 1. If the zero flag is 0, move on to the next instruction in sequence. Compare to CC.

CNZ (call if not zero). Go to the instruction addressed by this instruction if the zero flag is set to 0. If the zero flag is 1, move on to the next instruction in sequence. This instruction is the opposite of CZ above. Compare to CNC.

CM (call if minus). Go to the instruction addressed by this instruction if the sign flag is set to 1 ("minus"). If the sign flag is 0, move on to the next instruction in sequence. Compare to CC and CZ above.

CP (call if plus). Go to the instruction addressed by this instruction if the sign flag is set to 0 ("plus"). If the sign flag is 1, move on to the next instruction. This instruction is the opposite of CM above. Compare to CNC and CNZ above.

CPE (call if parity even). Go to the instruction addressed by this instruction if the parity flag is set to 1 ("even parity"). If the parity flag is 0, move on to the next instruction in

sequence. Compare to CC, CZ, and CM above.

CPO (call if parity odd). Go to the instruction addressed in this instruction if the parity flag is set to 0. If the parity flag is 1, move on to the next instruction. This instruction is the reverse of CPE above. Compare to CNC, CNZ, and CP above.

RETURN FROM SUBROUTINE INSTRUCTIONS.

These instructions get the computer back from subroutines to the instruction following the call instruction that caused it to depart. Specifically, they "pop" an address previously "pushed" onto "the stack" off of the stack and into the program counter, causing the computer to next execute the instruction located at that address. Execution then continues sequentially from there. Each return instruction is associated with a previous call instruction, i.e. the program counter always returns eventually to the point in a program that it previously departed from (to an instruction following a call instruction). Therefore the number of returns executed is always equal to the number of calls executed (unless the machine halts).

Since these instructions always "pop" addresses in the order opposite that in which they were "pushed," they can be said always to operate on the "next available address" in the stack, so that the address need not be stated in the instruction.

Like "jump" and call instructions, all but one of the return instructions are conditional upon the state of one of the flags. Flags are not affected by return instructions.

RET (return). Return to the most recently pushed address. This is an "unconditional return."

RC (return if carry). Return to the next address on the stack if the carry flag is 0. If the carry flag is 1, move on to the

next instruction in sequence.

RNC (return if no carry). Return to the next address on the stack if the carry flag is 0. If the carry flag is 1, move on to the next instruction in sequence. This instruction is the opposite of RC above.

RZ (return if zero). Return to the next address on the stack if the zero flag is 1. If the zero flag is 0, move on to the next instruction in sequence. Compare to RC above.

RNZ (return if not zero). Return to the next address on the stack if the zero flag is 0. If the zero flag is 1, move on to the next instruction in sequence. This instruction is the opposite of RZ above. Compare to RNC above.

RM (return if minus). Return to the next address on the stack if the sign flag is 1 ("minus"). If the sign flag is 0, move on to the next instruction in sequence. Compare to RC, RZ above.

RP (return if plus). Return to the next address on the stack if the sign flag is 0 ("plus"). If the sign flag is 1, move on to the next instruction in sequence. This instruction is the opposite of the instruction above. Compare to RNC, RNZ above.

RPE (return if parity even). Return to the next address on the stack if the parity flag is 1 ("even parity"). If the parity flag is 0, move on to the next instruction in sequence. Compare to RC, RZ, RM above.

RPO (return if parity odd). Return to the next address on the stack if the parity flag is 0 ("odd parity"). If the parity flag is 1, move on to the next instruction in sequence. This instruction is the opposite of RPE above. Compare to RNC, RNZ, RP above.

RESTART INSTRUCTION.

One special instruction, RST, resembles the call instructions in that it pushes a return address onto the stack and sends the computer off to another location. The address of the instruction following the RST instruction sequentially is pushed onto the stack, so that the computer will eventually return to its point of departure. Note that the RST instruction pushes the address of the instruction following RST -- otherwise the computer would return to the RST instruction itself and be trapped in an endless loop.

RST sends the computer (i.e. the program counter) off to one of eight pre-determined memory locations, each the first of a sequence of eight bytes, making up the first sixty-four bytes of memory.

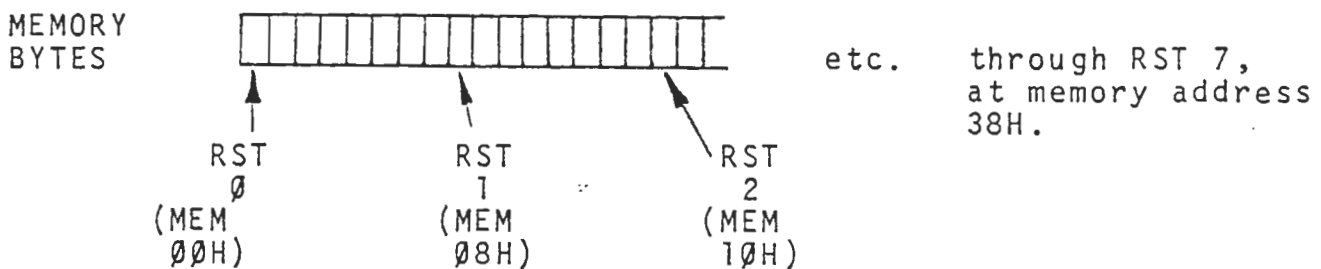

Actually, the eight bytes associated with each RST can be reached by means of other kinds of instructions -- jump and call instructions -- and need not comprise individual routines. In the POLY 88, all sixty-four of these bytes are used in the monitor (discussed later).

The CPU executes an RST at one of two times. An RST instruction may be written into a program, in which case the instruction is in effect a "call" instruction in shorter form -- one byte instead of three. More usually, the CPU executes an RST when the running of a program is interrupted "from the outside". For instance, loading onto tape is a very slow process for the POLY 88, which

can output data much faster than the tape recorder can properly record it. So the computer outputs data to the tape on an interrupt basis -- it occupies itself with other tasks until the output port electronics indicate that it is time to output another data item to the tape. This forces a restart, which puts a book marker into the program so the computer will be able to get back to its point of departure, and sends the program counter off to a predetermined location to begin execution of a brief routine that causes the computer to output a data item to the tape.

INTERRUPT FLIP-FLOP INSTRUCTIONS.

Sometimes it is important not to permit interruptions of a program. For that reason, interrupts can be disabled--input or output electronics can be prevented from forcing a restart. Whether or not interrupts are disabled depends upon the state of a single flip-flop, called the interrupt flip-flop. When the flip-flop is set to 1, input or output electronics can force a restart until the interrupt flip-flop is reset to 0, from which time interrupts are disabled till the flip-flop is once again set to 1. No flags are affected.

EI (enable interrupt). Set the interrupt flip-flop to 1.

DI (disable interrupt). Reset the interrupt flip-flop to 0.

INPUT/OUTPUT INSTRUCTIONS.

These instructions cause the computer to input data from or output data to a device external to the computer -- like a keyboard. To be precise, the instruction causes the CPU to open an input or output port, which is assumed to provide a connection with some device. No flags are affected.

IN (input). Load one byte from the designated input port into the accumulator.

OUT (output). Send the byte in the accumulator out to the designated output port.

HALT INSTRUCTION.

This instruction brings computer operations to a stop. It first increments the program counter -- adds 1 to it -- so that the computer will resume with the next instruction. No flags are affected.

HLT (halt). Increment the program counter, then stop.



SYSTEM PHILOSOPHY

The POLY-88 system represents a departure from the usual microcomputer system organization in that it contains, in its minimal configuration, several sophisticated I/O devices. These devices - a keyboard, a memory mapped video display, and a universal serial port - are at fixed addresses and are accessed and controlled in identical ways on every POLY-88. The result of this standardization is that the power of the elementary machine can be increased manyfold by the use of dedicated read only memories (ROMs) resident in the CPU as hardware. The ROM can assume that the special dedicated devices exist and can use them. Other systems have no way to know where the devices are located or even if they exist. The ROM in the POLY-88 CPU is called the monitor ROM, and is supplied with every POLY-88 system sold. It contains bootstrapping functions, front panel simulator functions, I/O device drivers for the self-contained devices, utility programs, and initialization routines that configure the system when power is supplied or the system is reset externally.

The ROM also provides another extremely important function: it sets up conventions for the logical expansion of compatible software systems that are well engineered from the ground-up. Unlike the owners of large computers, many microcomputer owners intend to develop their own software systems. The monitor ROM allows these systems to share resources such as I/O handlers, supervisors or special purpose subsystems, but most importantly, it allows users to share their programs. The standardization of I/O handling means Polymorphic Systems can publish software which will run on any POLY-88 immediately, without modification of sections of the binary program to cope with the various I/O methods used on each system.

The standardization does not, however, limit the use of the POLY-88 with other types of I/O devices such as TTY's, serial CRT's, paper tape reader/punches etc., because the ROM allows the standard devices to be re-allocated once the system is up and running. Any type of I/O device can be substituted for the standard devices by loading a simple driver routine for that device and installing its address in one of the monitor's "wormholes".* The wormholes are used to communicate between any user program and a standard I/O device of any type. Thus, once the driver program is written for the special device to be used, it will work for any program that communicates through the wormholes, and it will work on any POLY-88. The wormholes and system standardization are dealt with in a later section.

Another advantage of the dedicated I/O devices on the POLY-88 system is reliability. Specifically, the dedicated memory mapped video display allows the ROM to generate a simulated front panel which replaces the usual array of switches and light emitting diodes. The hardware front panel used on most minicomputers and many microcomputers is a rather expensive and complex device. It was intended, in minicomputer systems, to be used only in emergencies or when "bring-up" (bootstrapping) the system. Microcomputers, however, since they are frequently used for program debugging and are bootstrapped very frequently, have a tendency to wear out front panel hardware quickly. Furthermore, the hardware switches and lights have no access to the all-important CPU registers in microcomputers as they do in minicomputers. The front panel switches on most microcomputers

* The term "wormhole" has been used to describe a hypothetical astronomical situation where a black hole connects to the "other side" of the universe. When this happens, information can pass through the wormhole, in only one direction, much as "assumptions" pass down the monitor's wormholes.

can be used for little else than examining and loading memory contents in binary and starting program execution at a certain address. Some microcomputers use serial output devices with ROM based monitors for program debugging. These systems have extremely limited I/O speed, and therefore result in a tedious interaction between man and machine that the POLY-88 eliminates by putting all important information on the screen at all times.

The front panel display of the POLY-88 shows all of the CPU registers, the "workspace" of the CPU, and a memory "window". The "workspace" is the areas of memory pointed to by the double registers, including the program counter and stack pointer. The workspace display shows, therefore, the program area, stack area, and data areas pointed to by HL, DE and BC. The memory "window" is an 8 X 8 block of memory that is displayed, with addresses, on the bottom of the screen. It can be used to view a selected area of memory or to point to data areas being modified. The philosophy behind the front panel display is that it is best to use the computer's high output capability to effectively answer all the programmer/debugger's questions about the machine rather than require him to ask.

Another application of the "answer-the-question-before-it-is-asked" philosophy is in the POLY-88 bootstrap tape loader. The resident ROM contains a complete audio cassette tape loader which reads absolute binary programs in a sophisticated format called POLYFORMAT. The files in this format are broken into short blocks, each with a name and number recorded with it. These names and numbers are displayed on the dedicated video display whenever tape is being read. They give the operator an indication of what file he is reading, where along the length of the file he is, and whether or not the tape is even being read properly. The names and record numbers effectively make the data on the cassette visible, so that files can be separated from each other and located.

The POLYFORMAT has other advantages also. Its block structure allows the tape to be stopped in the event of an error and restarted before the erroneous block. Some recording formats require a file be read entirely without errors, or the whole loading must be restarted. The names on the records allow the computer to identify needed data on the tape such as relatively complex constructs like subroutines in a library that must be linked in a relocatable linking loader. The names also allow files to be packed closely together, without time-wasting leaders. POLYFORMAT includes definitions of several types of blocks (or records) such as: absolute binary (for programs), data (for text etc.), end (stops load), auto-execute (jumps into given address), and comment (displays a message for operator). The comment record is another example of the visibility philosophy. By placing comment records at the beginning and end of a file, the tape is made even more visible.

USING THE ABSOLUTE TAPE LOADER

The tape loader mode of the monitor may be entered at any time by resetting the CPU (either by depressing the front panel reset button or by applying power to the system). When tape mode is entered, the system video display is cleared and a small block appears in the upper left corner of the display. The small block is the cursor symbol used by the display driver program "DSPLY" which is resident in the monitor ROM with the loader. In order to load a POLY FORMAT absolute binary tape, the loader needs to know which encoding scheme to use and the name on the desired file. The encoding scheme can be indicated by typing either a "B" or a "P" on the system console keyboard. These stand for BYTE standard, the encoding scheme used in PolyMorphic published software, and POLY-PHASE, PolyMorphic's special very high speed encoding scheme. The loader transmits all necessary configuration information to the 8251 USART and the 5307 programmable baud rate generator on the CPU card

4.0 POLYFORMAT TAPE LOADER
FLOWCHART

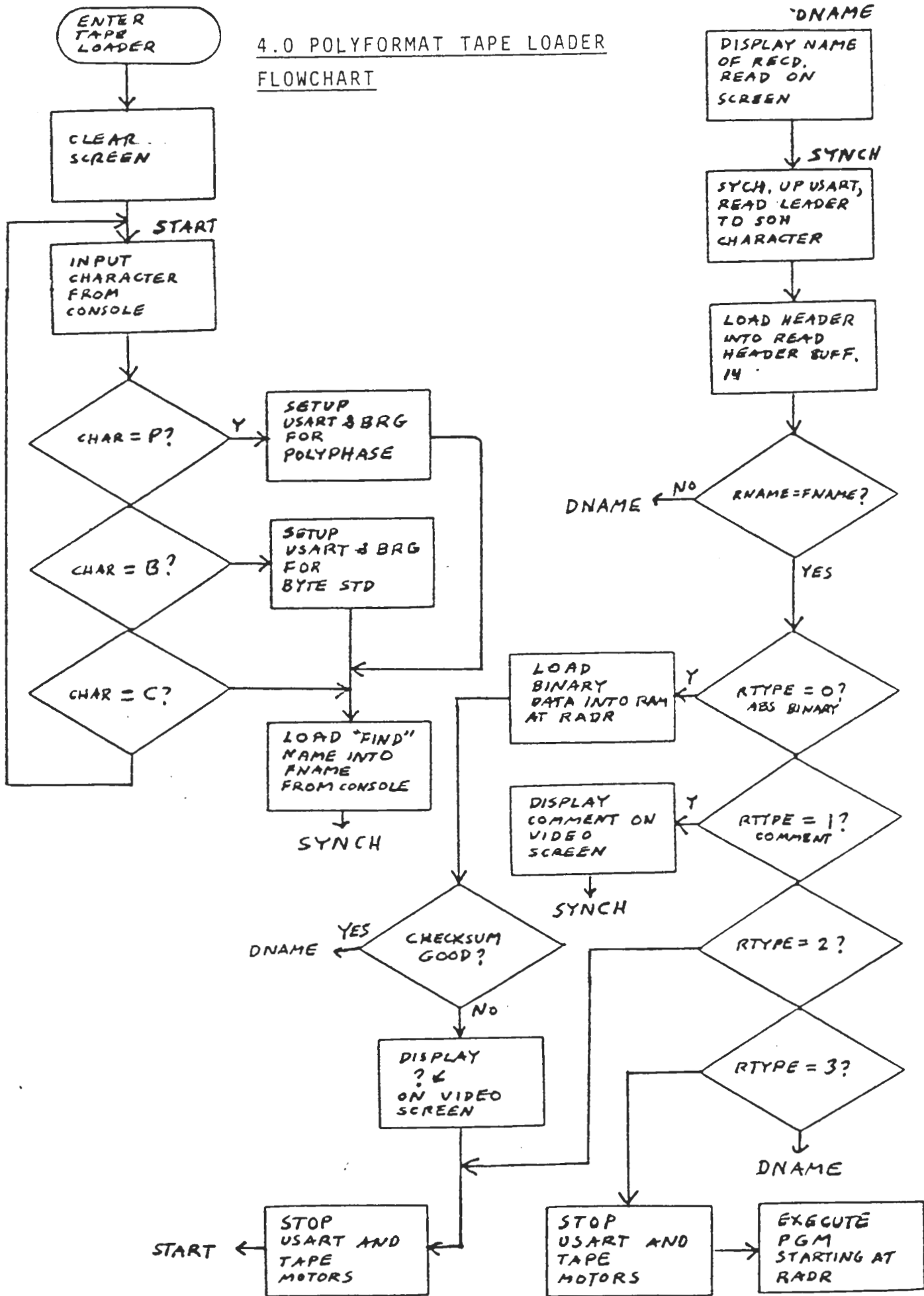

according to the encoding specification. It selects the zero designated mini-card, which should be the audio cassette interface mini-card being used for the load.

When this is done, the cursor moves down to the next line and the loader expects a 1 to 8 character file name to be entered followed by a carriage return. The cassette motor control line is turned on, and the tape is read, comparing the record names found with the name of the desired file. As records are discovered with the correct name, they are accepted. Reading continues until an END or AUTO-EXECUTE type record is encountered. (See section on tape format). If an END record is found, the cassette motor control line is turned off and the loader waits for another encoding specification (B or P followed by file name) or a "continue" command (just a "C" is typed-the old* EXECUTE type record is found, the cassette motor is turned off and the loaded program is executed by jumping to the address indicated in the AUTO-EXECUTE record.

Each record encountered, whether it is accepted or not, is acknowledged by having its name listed, followed by its record number, on the system console display. Thus if it is desired to simply examine the contents of a certain cassette tape, the tape loader can be told to search for an impossible name, such as no name at all. It will continue indefinitely, searching for the nonexistent name on a record, each time showing the name and hexadecimal record number of each record it finds. The record number is recorded in the RCD# field of the record.

Occasionally, while a file is being loaded, a COMMENT type record will be encountered and the message it contains will be displayed on the system display. All files should have a COMMENT record at the beginning for documentary purposes, and it is the appearance of this COMMENT message on the system video display that indicates the loader has recognized the desired file and will load it. COMMENT records are very useful,

*name is used).

as they can indicate such things as the portion of a large program that has loaded (the message serves as a flag some distance down the tape), or that a program has finished loading and is executing (an AUTO-EXECUTE followed the COMMENT).

All mass storage systems must cope with errors in some way, and magnetic tape is far from an exception. A very long program has a relatively high probability of loading incorrectly simply due to noise and other factors which create "soft" or read-only errors. If the lost data can be re-read, the soft error is unlikely to occur again, and the loading can continue. The POLY-FORMAT allows an erroneous record to be re-read without starting at the beginning of the file. The record structure of the POLY-FORMAT is such that each record is completely self-consistent. This means that if the cassette tape is rewound beyond the erroneous record and the loader and recorder are restarted, the loader will find the first complete record (if it is restarted in the middle of a record) and will reload records up through the record that was lost. This process may be repeated until a difficult record loads properly - a very time consuming proposition if considered with a file structure which requires restarting of the load at the beginning of the file. An error is indicated to the operator by a question mark on the video screen and stopping of the cassette motor. If the motor control is not being used (some recorders have motor voltages and polarities inconsistent with the audio cassette motor control drivers) then the tape will continue to play after the loader has stopped at the error. In this case, it may be necessary to rewind the tape some distance, and it will be helpful to check the record numbers to find the original spot. A depression of a C key on the keyboard will resume reading of the tape. If the motor control is being used, it will be impossible to rewind the tape until the motor control is again

turned on, and again, this can be done by simply depressing the C key on the keyboard. The name and format of the file being loaded is retained and need not be re-entered.

FRONT PANEL MODE

Instead of a hardware front panel, the POLY-88 uses a program which drives a simulated front panel display onto the system video terminal. The display, shown in appendix A, is present whenever the monitor is in the front panel mode, and is updated each time a command is executed, or the registers are modified in any way. The display is thus always a reflection of the contents of the registers and memory at any instant, just as if it were harwired into the CPU and the memory address and data busses. Visible in the display are:

- *contents of CPU registers: program counter (PC), stack pointer (SP); accumulator (A) and general purpose registers.
- *contents of memory areas pointed to by general purpose registers: program area, stack area, and the areas pointed to by BC, DE, and HL.
- *a moveable memory window which shows 64 contiguous locations and their addresses.
- *the status of the carry, sign and zero flags decoded into an easy to read form.

The front panel display driver program is complemented by a command interpreter program. In most cases, a single keystroke on the system console keyboard will allow the operator to:

- *interrupt a running user program to bring up the front panel.
- *single-step, run with breakpoints, or return to full speed execution of the user program.
- *move the memory window to a given location.
- *enter single bytes or long strings of bytes in hexadecimal into memory with instant verification of entered data and easy backup for error correction.

*trace byte-reversed address pointers in memory by moving the memory window to the given address.

*move the memory window to point at the program, stack or data areas currently being used by the user program.

The commands in Appendix B are primitives and should be used in combination to provide a powerful interactive system for manipulating memory data and debugging machine language programs. There is, for example, no command for setting the contents of any given general register. Instead, there is a command for pointing the memory modify window at the save area on the system stack where a given register was stored. This allows the contents of the register to be modified using the rest of the commands, such as the Jumbo (J) command, which allows entry of a full address in its normal byte order instead of the byte-reversed order of 8080 addresses. Another example might be using the I (indirect) command after pointing the window at the register save area on the stack. This will point the window at the memory area that the register points at.

In other words, if the register was the program counter, a sequence of "SPI" would leave the window displaying the program area. The program area could then be modified using the full power of the front panel commands.

In order to fully introduce each command and its possible combinations with others, the following text will take the reader step-by-step through the procedure of loading a simple program, correcting entry mistakes, checking its logic using the I command and the X (single-step) command, and finally, running it.

USING THE FRONT PANEL MODE

Suppose we wish to construct a simple program in an available location in RAM. The demonstration we will use is a video display test which loads each location of VTI memory with the low-order address byte of each location. This has the effect of

displaying all possible characters and graphics patterns on the screen in a cyclic group of 256 characters. The display is thus repeated four times vertically.

The program looks like this in symbolic assembly language:

```
LOOP:    LXI      H,0F800H    ;start at top of system screen
         MOV      M,L        ;put out each location's low addr byte
         INX      H          ;next location
         MOV      A,H        ;get high addr byte for comparison
         CPI      0FCH       ;is it off the screen yet?
         JNZ      LOOP       ;no - keep going
HLTAGN:  HLT                ;yes - OK, were done, stop.
         JMP      HLTAGN     ;sometimes interrupts break a HLT, so
                               ;go back to the HLT when they do.
```

In hexadecimal machine code:

```
21 00 F8 75 23 7C FE FC C2 83 0C 76 C3 8B 0C
```

assuming that we want to load it at C80H, which is a free space in the system RAM. The problem now is to correctly load this hex into the RAM at that address and then send the CPU off executing it.

Turn on the POLY-88, and push the front panel reset button. The machine should have a CPU card with 4.0 monitor installed as per appendix A, and a video terminal interface card with its address switches at 0F800H, also as per appendix A. The screen should show only the small cursor block in the upper left corner. This is the prompt character (actually no prompt char. per se')*for the tape loader system. Since we want to use the front panel mode, push the control Z (hold down CTL before and while pushing Z). Instantly, the front panel display should appear on the screen. Appendix C shows an example of the front panel display with an explanation of the various data areas in it. For now, the part that interests us is the memory modify window at the bottom. The window is a 64 byte section of memory which shows, in hex, the locations before and after the "current" window position. The byte actually at the current window position is indicated by a right-arrow at the left
* but only a cursor symbol.

center of the block. The address of this byte and the leftmost byte in each row is displayed at the far left of the screen, also in hex:

Now, to enter the test program into the RAM, we first point the window at the desired address:

```
LC80(ret)
```

where "(ret)" means carriage return (CR on some keyboards, RET on others). The display should now show 0C80 in the address next to the arrow. To enter the bytes of our program, we can simply type the hex for each instruction followed by a space. When hex is being entered, the termination character for each byte is interpreted as a valid command. In this case, the space indicates that the window pointer is to be incremented, hence each byte goes into a succeeding location. The program entry looks like this:

```
21(space)00(space)F8(space).....76(space)C3(space)8B(space)  
0C(space) where the "(space)" means, of course, a blank space  
from the space bar.
```

Suppose an error had been made while entering data into memory. The window may be moved back one location with the backspace command, control H. The erroneous byte may be reentered, and after the usual space, the rest of the program bytes may be entered. If the error is detected before a termination character is typed, it is only necessary to continue typing in the hex for the correct code until the last two hex characters shown at the bottom of the screen are correct. The hex input routine used by the command interpreter shifts hex nybbles into a two byte register from the bottom, so when it returns to the calling program on receipt of the termination character, it leaves only the last four nybbles in the

double register. In the case of hex input to the window location, only the bottom two nybbles are actually used by the program. Any previous hex digits are ignored. The use of the last hex characters typed in is built into all the other commands which expect a hexadecimal input of some kind.

One of the commands which expects a hex input is the J command. J stands for Jumbo, a mnemonic which indicates a double word is to be entered at the current window location. The J command is followed by up to four hex nybbles or characters and a carriage return, thus:

```
JF800(RET)
```

The contents of the two locations at and following the window are modified to contain the "byte-reversed" double word that was entered. Actually, as mentioned above, only the four last characters typed in for hex are used, so if an error is made on entry, just keep typing until all four of the last characters are perfect. Since the register that the bytes are shifted into is started out with all zero contents, a small hex number need not be typed in with leading zeroes (unless, of course, it is being re-typed after an error). The way to enter an address of 0C80, then, is to type the J followed by C80 followed by a carriage return; JC80(ret). One important fact about the J command is that it does not move the window pointer. The reason for this is to allow the use of the I command immediately after a J. Sometimes this combination can be useful.

The I command is the "indirect" operator. It takes the two bytes at and following the window location and puts them into the window pointer. It "jumps" to the address currently shown in the memory at the window pointer. This is a very useful function for tracing programs that do JMP's or CALL's by placing the window pointer over the address of the JMP or CALL and then typing I. It is also immediately after a "J" as a check

of the address entered. If the address is correct, the window will show the data that are supposed to be pointed to.

It should be pointed out that the I and J commands work with double words in memory that are stored in what is known as "byte-reversed" format. The 8080 puts the high order byte of an address stored in memory into the high order register of a pair when POP or LHLD type instructions are executed. PUSH and SHLD instructions operate similarly. Addresses in JMP and CALL instructions also follow this rule. Although it seems logical to arrange addresses this way, it is normal to enter data into memory incrementing addresses between bytes entered. This, unfortunately, means that addresses are typed in low order byte first. Addresses are also displayed backwards in the normal representation of data in memory: addresses increasing to the right. The seemingly backwards storage of addresses has come to be called "byte-reversed".

Now that the program has been entered correctly, we would like to run the program. The first thing to do is to set up the program counter to point at the first instruction of the program. To do this we will use one of the S commands: SP, which will point the window at the area on the system stack where the program counter is stored. Now, of course, the actual program counter could not be stored on the stack, because the program which we are running that displays the front panel and interprets our commands is moving the PC up and down in the monitor. The program counter we will modify is the one that will be restored into the "real" program counter when we want to execute the program. In other words, as far as we are concerned, the actual program counter is stored right there in memory, along with the values of all the other registers. Since the stack may have any value in it when we preseed control Z, the locations actually used to store the register values are unknown. The monitor however, keeps track of these locations

and will point us at any one we want if we use the S type of command.

So, to set up the program counter, we point the window at the proper place on the stack with an SP command, and then do a J:

```
SPJC80(ret)
```

The front panel display at the top of the screen should now show the 0C80 we just entered in the PC register. The area to the right of the PC double word shows the memory pointed to by the PC, which is the program area. It should show part of the program we have loaded. The arrow at the bottom of the front panel display points upwards at the actual locations that all the register pairs point to. The 21 hex that was the first opcode of our program should be visible above this arrow in the field next to the PC.

The memory window should also show the new PC value, except it will be backwards because of the "byte-reversed" address format. The window should show 80 followed by an 0C. Now, to check this value, let's see if the PC actually points at the program. Press I and the window should show the first instruction again: the 21H. For one last check before we run the program, type a (ret) and the window will scroll up one row (8 bytes). We could move backwards one row by typing line feed (LF). This gets us closer to the address in the JNZ instruction that we want to test. Space down to the locations following the JNZ (following the C2) and press I. The window should point at the address we called "LOOP" in the symbolic assembly program. The instruction at this address was a MOV M,L, which has hex opcode 7C. The 7C should be in the memory window after the I command is typed.

If this last test works, we are ready to step the program

through one cycle of its loop to see what happens. The program counter is still set up to 0C80, so press the single-step command key, X. The program counter will advance to 0C83 and the HL register pair will be loaded with F800, the data from the second two bytes in the LXI H instruction. On the next single-step, the first byte will be transmitted to the video screen, but since the front panel display is replaced on the screen after the byte the instruction transfers, we do not see anything happen. The next instruction increments HL to F801. Next, A gets the contents of H, then it is compared with FC hex in the CPI 0FCH instruction (FE FC). Finally, since F8 does not equal FC, and the zero flag is not set, the JNZ instruction goes back to 0C83 to continue the loop.

The program seems to work when single stepping, so the final test is to execute it at full machine speed. This can be done by pressing G. The entire screen should fill with the test pattern of consecutive ASCII characters and graphics patterns, in a cyclic replication four times down the screen. The single-stepping lost the first character in the upper left corner of the screen, though.

When the test pattern is verified, the front panel mode may be re-entered as it may be at any time by typing the control-Z. The front panel will appear, showing the program counter just as it was, halted at the end of the program on the 76 (HLT) instruction. The HL pair should have the last screen address used: FC00H.

4.0 UTILITY PROGRAMS

In addition to the directly operator-apparent features of the 4.0 monitor, there are also some software-apparent features which make I/O handling and other difficult or routine operations easy in machine language. Program patching is easy on the 4.0 monitor because the most common patching area for programs being moved from system to system is in the I/O section, and the 4.0 monitor contains patch routines for direct substitution into most programs. These include routines for transmitting characters from the accumulator to the console display from the keyboard to the accumulator, and from the USART port to the accumulator. Several hexadecimal conversion routines are included which will handle nybble, byte and doubleword conversions from the keyboard. Other utility functions include lower to upper case folding of characters input from the keyboard (lower case characters are converted to upper case before passing on to user), screen manipulations such as clear, tab, space and carriage return, and USART setup programs for Polyphase, Byte Standard or user defined USART mode.

The following discussion will be found useful to beginning programmers who wish to use the utility routines to simplify their programming. Advanced users will want to study the section on software conventions and methodology in order to make their complex programs more general, flexible and compatible with both PolyMorphics published software and other user's software. The utility programs in the 4.0 monitor, although designed to be universally available to all users of POLY-88 systems, may occupy different address areas in later versions of the 4.0 (4.1 etc.). This would make programs written using the utility programs obsolete, and would require adjustment of the addresses in all programs that were to be transferred from one version to the next. To avoid this mass adjustment of addresses in user code, PolyMorphics will not publish any version of the 4.0 monitor with the utility routines relocated unless it is absolutely-necessary to do so. However, the possibility does

exist, so it is wise for programmers who intend to use the utility programs to be aware that this may happen. In any case, the utility routines are intended only to allow users to construct small software systems without the need to generate all the standard utility functions themselves.

The vital utility functions - the I/O functions - are made available to all levels of programming without reservation. The standard character transmission operations are made available through an ingenious device known as the "wormhole vector", which puts the I/O routines at absolutely standard positions in the CPU resident system RAM memory. Thus, no matter what version of monitor is being used, or even whether the monitor has been replaced by a disk operating system or time-sharing system, the wormholes in the vector will remain fixed and programs using them for I/O need not be changed. It is possible, then, for anyone to write programs which will last through many cycles of monitor or supervisor redesign by simply using the wormholes for I/O rather than any fixed-address I/O subroutines.

The concept of standardizing the addresses of various important pieces of information has been extended in 4.0 to include many things besides the addresses of the character I/O handlers. The storage areas for such widely accessible variables as the present video screen starting, ending and cursor addresses are defined by the 4.0 in an absolute, fixed manner, so that any program can modify or examine them with confidence in their locations. The definition of all the standard locations and methods of use of the variables in the system RAM are what give the POLY-88 its software flexibility (an interesting apparent contradiction: the absolute rigidity results in increased flexibility). The techniques for using the wormholes and other "system variables" (see glossary for definition of "system variables" and other terminology used here) are described in detail in later sections. It is the intention of this section,



however, to describe the use of the utility functions by programmers who would rather see their systems work than to generate a masterpiece of programming generality and portability.

First, let us look at the basic I/O functions. Almost all programs need some sort of communication with the keyboard and system video display. The first two wormholes are defined for this purpose. Wormhole zero (WH0, pronounced whoo) is the console input wormhole, while wormhole one (WH1, pronounced whee) is the console output wormhole. Notice that these wormholes are defined by their logical rather than their physical function. Either of them may be changed to operate with any actual physical console input or output device desired, but as far as the programmer is concerned, all they do is communicate with the computer operator through some sort of character-oriented device. The total effort that must be expended to talk to the operator is thus, to do a CALL to the appropriate wormhole. The character will be taken from the accumulator or placed in the accumulator by the subroutine that the wormhole "contains" (checkout how the wormholes actually work if you want to, but for now, pretend each one contains a complete subroutine in its four bytes). All the wormholes work the same way, by transferring one character at a time from the accumulator the addresses of all the wormholes are shown below.

| <u>Wormhole</u> | <u>Address</u> | <u>Logical device accessed (example)</u> |
|-----------------|----------------|--|
| WH0 | 0C20 | console input (generally a VTI keyboard) |
| WH1 | 0C24 | console output (generally a VTI screen) |
| WH2 | 0C28 | system input (binary from a mag.tape) |

| | | |
|-----|------|--|
| WH3 | 0C2C | system output (binary to a mag tape) |
| WH4 | 0C30 | aux..syst. input (secondary mag or paper tape) |
| WH5 | 0C34 | aux. syst. output (secondary tape) |
| WH6 | 0C38 | text input ("saved" pgm listing from tape) |
| WH7 | 0C3C | text output (printer or tape for listings) |
| WH8 | 0C40 | undefined input |
| WH9 | 0C44 | undefined output |

The first three wormholes are loaded by the monitor with the proper data to make them act as subroutines when the system is powered up or when the front panel reset button is pushed. The subroutines in the monitor are "installed" automatically in WH0, WH1 and WH2, but the other wormholes, since they require very complex I/O handlers, must be installed later, with I/O routines in RAM. The actual routines that the monitor installs are: the DSPLY program - for driving a PolyMorphics VTI-64 or 32 video display, KI - for getting characters from the keyboard port of the VTI board, and USRTI - for getting characters from the 8251 USART on the CPU. As described later, these default allocations may be changed easily. Let us illustrate the use of the wormholes with a program which echoes the characters typed on the VTI keyboard port onto the VTI display:

```
NEXTCH:  CALL WHO           ;get a character from console device
          CALL WH1          ;put on console display
          JMP  NEXTCH       ;go back for more
```

Notice that even this simple loop allows complete control of the video display through the DSPLY routine which recognizes many of the standard control codes.

DSPLY, KI and USRTI

More specifically, the codes that DSPLY recognizes are:

| <u>ASCII code (hex)</u> | <u>keypress</u> | <u>function</u> |
|-------------------------|-----------------|---|
| DEL 7F | rubout | moves cursor back, deleting char. |
| CR 0D | return | skips a line and puts cursor at left side of screen. "car. ret." |
| FF 0C | CTL/L | clears screen, leaving cursor at "home" - upper left. "form feed". |
| VT 0B | CTL/K | moves cursor to "home" position, in upper left corner. "vertical tab". |
| HT 09 | CTL/I | skips cursor to next horizontal position evenly divisible by eight. "tab" function. |

DSPLY also does a little rearranging of the character set given to it. If the character is a control code, as are several of the above, it is not printed on the screen. However, if it is a control code but has a high bit 7 (the top bit) then it will print as a greek character, but will not work as a control character. It is thus impossible to use the graphics capability of the VTI card by transmitting characters to the screen through DSPLY. Any graphics character comes out as a regular ASCII character, as if bit 7 were low. Note that DSPLY corrects for the backwards polarity of bit 7 as the VTI card expects it. Normally, a high bit 7 will display graphics, and a low bit 7, ASCII, when bytes are transferred directly to the VTI as if it were memory. The DSPLY program will take either polarity in bit 7, and will always generate characters rather than blocks. The map of the DSPLY input expectations looks like this:

Mapping of DSPLY expected
input codes.

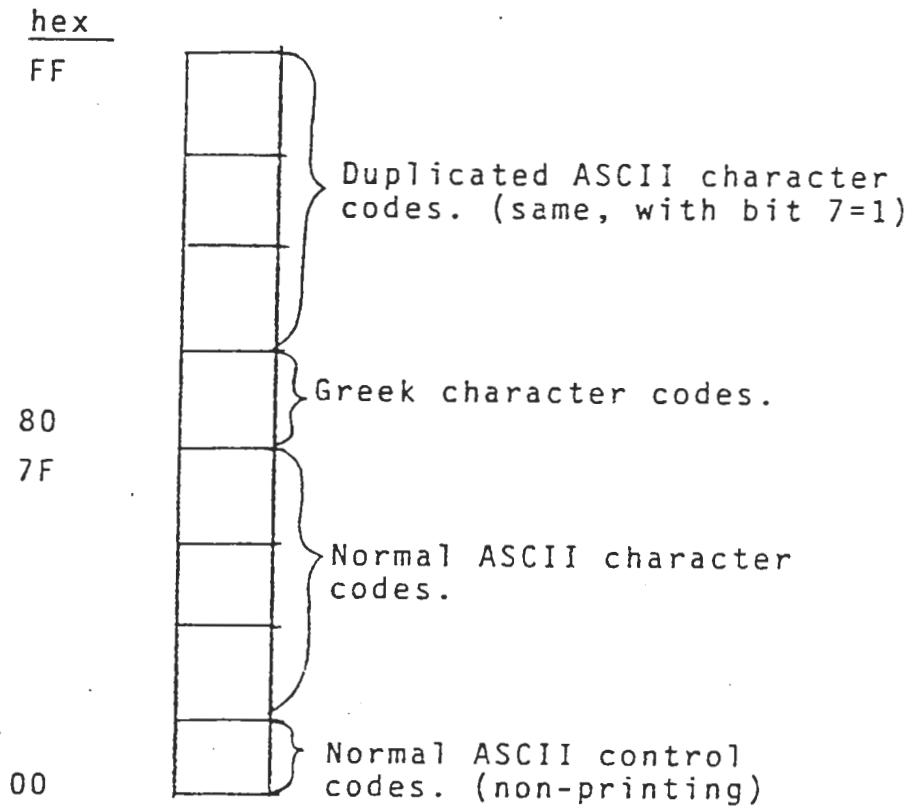

The other two default wormhole subroutines operate in a more elementary manner. Neither the KI nor USRTI wormhole subroutines map their character codes in any way. KI gets 8 bit characters from the VTI keyboard without zeroing bit 7. It is possible using KI to load binary data or special function codes from an auxiliary keyboard from the VTI keyboard port. Normal ASCII characters are expected to have zeroes in bit 7, so, if bit 7 of the keyboard is not grounded, then it should be zeroed by the software. Bit 7 here means, as usual, the highest bit, not the next to highest. USRTI operates exactly as KI except that it fetches bytes from the USART.

To test the USART and a cassette tape system, the following direct echo loop can be loaded into a free spot in RAM:

```
LOOP:      CALL  WH2      ;get a byte from USART
           CALL  WH1      ;display its ASCII representation on scrn
           JMP   LOOP      ;go back for more
```

Before this program will work, the USART must be configured to read from the tape. To do this, reset the system with the front panel button, and proceed as if a tape were being loaded. Put in a dummy name and a carriage return. Then bring up the front panel with a CTL/Z, and run the loop. When the cassette is played into the USART through an audio-cassette interface, the characters on the tape will appear on the screen. Many of the characters will be control codes and will clear the screen or return the cursor, but some of the patterns on the tape will be discernible, such as the string of lower case f's that represent the leader of hexadecimal E6's on a POLYFORMAT record.

APPENDIX A. INSTALLING 4.0

A number of hardware changes are necessary to convert the P-88 to 4.0 monitor compatibility. After installing the 4.0 monitor ROM (read only memory) in the right-most ROM socket on the CPU card, the following points of possible incompatibility should be checked and corrected as needed:

1. The system video screen, although it may be moved once the system is running, is initialized to run at F800 hex. In order to change the address on the video card, configure the address selection switch as shown below. The movement of the video address allows greater expansion of contiguous program memory.

OLD SWITCHES

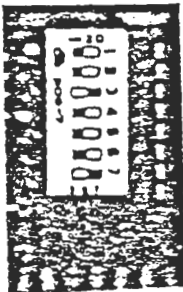

NEW SWITCHES

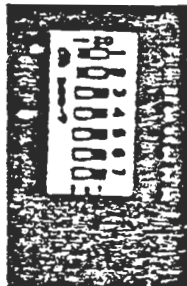

2. A short trace labelled "K" on the back of the CPU card is normally cut for the earlier monitors since they do not use interrupts from the USART, and this trace connects the USART interrupt to VI3 (vector interrupt three). This trace should be reinstalled if it has been cut by soldering a short piece of bare wire into the two pads on either end of the trace as shown in Fig. A.2.

Figure A.2. "K" TRACE REINSTALLATION

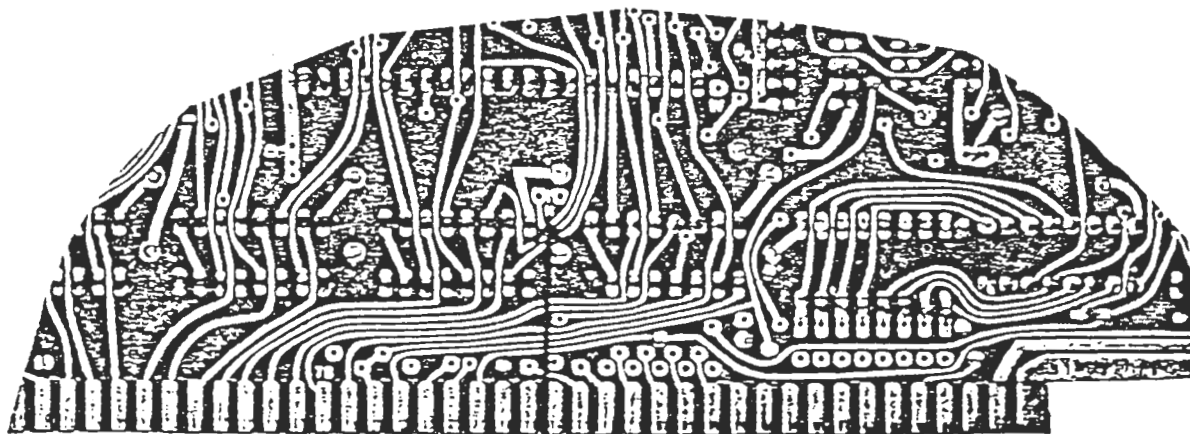

"K" trace

Bottom edge of back of CPU card shown.

3. The 4.0 monitor uses the 60 Hz real time clock interrupt which is normally not connected for the earlier monitors. To connect the clock, run an insulated 2" jumper wire on the back of the CPU card from the "A" pad to interrupt pad 1. The "A" pad is on the right center of the CPU card

Figure A3. RTC JUMPER

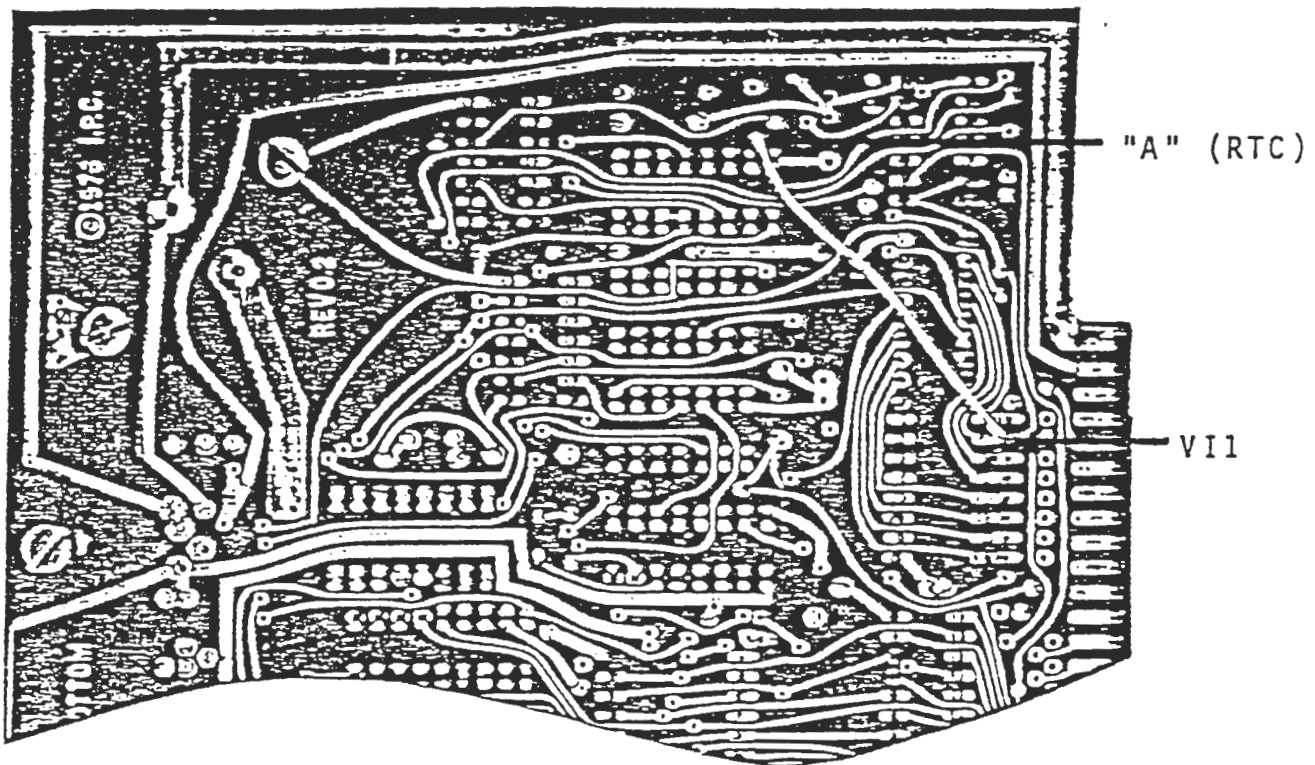

(looking at the back), however, the "A" is on the front of the card, next to a 74LS109. Again on the back of the card, vector interrupt 1 can be found in a group of eight pads arranged in a horizontal line at the bottom right. Interrupt 1 is second from the right in the upper series of eight.



5. Earlier monitors had keyboard driver routines which zeroed the high order (bit 7) bit of the data coming from the keyboard. The 4.0 monitor leaves this bit unchanged when data is obtained from the keyboard via the keyboard driver routine. This is so the high order bit may be used for inputting binary directly through the keyboard or for increasing the number of valid key codes on the keyboard to include special functions. An example of this might be the use of the keyboard driver routine in a text editing system where a special cursor control keypad transmits a high bit 7, and the normal keyboard transmits the normal zero bit 7.

The net effect of this change is that all keyboards must transmit a zero bit 7. To do this, make sure that this bit is grounded on the keyboard itself, or ground the "B" pad on the VTI board. This pad connects to bit 7 of the input to the 8212 keyboard data latch. It is near the strobe-polarity jumper pads in the upper right corner (looking frontwise at board). Version 1.0 and later video cards will all omit the "B" pad, because their keyboards are expected to supply a zero bit 7.

APPENDIX B. MONITOR COMMANDS

The following list comprises the set of primitive operators or commands available in the 4.0 monitor in the front panel mode. Front panel mode may be entered at any time by striking the control Z key on the system console keyboard. Further commands on the system console keyboard have effects which are immediately reflected in the front panel display. When front panel mode is to be exited, the interrupted program may be restarted transparently, since the entire status of the CPU is saved on the current system stack upon entry to the monitor.

| <u>Key or key sequence</u> | <u>Effect</u> |
|----------------------------|--|
| control Z | Interrupt currently executing program. Front panel mode is entered. Status of CPU (PC,SP,regs.,flags) is saved on the system stack. |
| X | Execute the next instruction of the interrupted program and return to front panel mode to display results. |
| G | Go to the next instruction of the interrupted program and do not return. |
| Lxx..xx(CR) | Look at address xx..xx with the memory modify display. The variable-length address (up to four last hex digits accepted) is placed into the memory modify display pointer. |
| space | Move the memory modify display pointer forward one and redisplay everything. |
| BX (control H) | Move the memory modify display pointer back one and redisplay everything. |
| CR (carriage ret.) | Move the pointer forward 8 positions. This has the effect of scrolling the display up one line. |

Key or key sequenceEffect

LF (line feed)

Move the pointer back 8 positions. This has the effect of scrolling the display down one line.

xx xx(any command)

The last two hex characters before the command are entered into the location pointed to by the memory modify pointer. The command is then executed.

Jxx xx(CR)

Jumbo data word (double-word) is entered in byte-reversed format at and following the memory modify pointer. The last four hex characters before the carriage return are used.

I

Indirect display. The two bytes at and following the memory modify pointer are placed into it in reverse order, so that if they represent the address in a JMP instruction, the pointer will be moved to that address.

SP (Program Counter)
SH (HL)
SD (DE)
SB (BC)
SA (Accumulator/flags)

Stack modify. The memory modify pointer is moved to that address on the stack where the indicated register pair was stored on program interrupt. If the location at the memory modify pointer is modified, the register display will show the contents of the appropriate register as having changed, and when the G command is executed, program execution will continue with the new value. To enter a double-word, the J command may be used. A single byte may be inserted in one register of a pair by simply entering it for the lower register and by spacing once over the lower register to enter it into the upper register. Data at the address pointed to by a register pair may be modified by using the I command to move the memory modify pointer to the appropriate area of memory.

Key or key sequenceEffect

U (or other illegal
command)

Update the display. This can be used to watch dynamically changing events such as the real time clock counter being incremented in system memory, or an I/O buffer filling.

T

Tape system is entered. This is the same tape system entered on power up or reset from the front panel reset button, except that the system constants that are initialized by either of these latter entry methods are left intact. These include the video screen address, console wormholes and interrupt service routine addresses for the USART, keyboard and RTC.

APPENDIX C. FRONT PANEL DISPLAY

Shown on system video screen

Explanation of display

```

PC 008C 0C 0C 7E B7 C2 8B FE 8C
SP OFFA FF 8C 00 FB 7C 2F 31 A0
HL 0C0C 49 48 D5 10 08 56 C6 DA
DE 0C51 21 00 88 A7 BA DC OF 1F
BC 0000 A0 19 70 31 00 10 06 FF
AF FF86 CNZ      ↑

```

```

PC=008C hex   (PC)=B7 hex
SP=OFFA      (SP)=FB
H=0C   L=0C  (HL)=10
D=0C   E=51  (DE)=A7
B=00   C=00  (BC)=31
A=FF
flag byte=86

```

```

1FE3   FF FF FF FF FF FF FF FF
1FEB   FF FF FF FF FF FF FF FF
1FF3   FF FF FF FF FF FF FF FF
1FFB   FF FF FF FF FF 01 CA CD
2003 → 00 AA FE 3A 40 21 CE 8F
200B   76 C2 3C 03 2A 27 0C 3A
2013   26 4F 3A 29 2A 44 0C C9
201B   B9 83 B2 16 F0 C8 33 BA

```

Carry, sign and zero flags are shown as all high ("CNZ") for explanatory purposes only, as this is an impossible condition and does not correspond to the flag-byte shown. A low flag is displayed as a blank, eg. " " means C=S=Z=0.

Memory window is displaying data around 2003 hex. If data is entered it will replace the 00 to the right of the arrow. Addresses increase from top to bottom and left to right. Location 2003 contains 00, 2004 contains AA etc.

The display shown above appears on the POLY-88 system console whenever the monitor is in the front panel mode. It is updated each time any command is executed, so it always reflects the contents of the memory and registers accurately.

The top of the screen shows the simulated front panel itself, and the bottom shows the memory window. To the right of each register pair is a display of the locations on either side of the address in the register pair. The up-arrow near the middle of the screen points to the actual location that the register pair points to. This is the location that would be modified or read if the associated register pair is used as a pointer (LDAX B, LDAX D, or MOV A,M type of instructions). Since the A register and the F (flag) byte are never used as concatenated bytes in an address, they do not have a memory

APPENDIX D. POLYFORMAT DEFINITION

The next page shows five examples of POLYFORMAT records, one of each of the currently defined types. Each record has the same basic structure as shown below:

```

/ SYNC /SH/ NAME /RECD#/LN/ADDR /TP/CS/
E6 E6 E6 E6 E6 01 a a a a a a a r r l b b t c

```

Data

```

/ DATA /CS/
d d d d d d d d d d c

```

Each record consists of a HEADER followed by a possible DATA field. The fields in the header above have the following meanings:

| <u>field designator</u> | <u>purpose/description of field</u> | <u>field name</u> |
|-------------------------|-------------------------------------|-------------------|
| a | eight character record name | NAME |
| r | record number (0 to 65536) | RECD# |
| l | length of data 1 to 256 bytes | LN |
| b | bias address or absolute addr. | ADDR |
| t | one of five record types | TP |
| c | checksum modulo 256 neg.sum | CS |
| d | data bytes binary 8 bits | DATA |
| E6 | hexadecimal E6 sync chars. | SYNC |
| 01 | ASCII "start of header", SOH | SH |

All records begin with the SINC characters (exactly 16 of them) followed by an ASCII SOH character. NAME and RECD# are on all types of record, but record types without data have undefined LN fields. The ADDR field is defined for absolute binary types and auto-execute, in which cases it indicates loading or branching

address respectively. Both RECD# and ADDR are in the standard 8080 byte-reversed format, so that they work with LHLD and SHLD instructions. In other words, the upper byte in memory contains the most significant byte of the double word. The type field has the following meanings:

| <u>TP (type) field</u> | <u>Record type indicated</u> |
|------------------------|--|
| 00H | ABSOLUTE BINARY. Used for program storage where data must be reloaded into the same place it was copied from originally. The address of the area is contained in the ADDR field. Data is copied starting at this address for the number of bytes given in the LN field. |
| 01H | COMMENT. The data in the data field is echoed to the system video display as a message to the operator. The checksum on the data may be ignored. |
| 02H | END. This terminates a file. Any physical device capable of being turned off is stopped, if it is the device supplying the data. LN, ADDR fields are undefined. No data follows the header. |
| 03H | AUTO-EXECUTE. The address in the ADDR field is jumped to. LN is undefined and no data follows the header. |
| 04H | DATA. Information in the DATA field is loaded into a buffer somewhere and used by a program. Data in this record has no address associated with it as object code programs do, hence the ADDR field is undefined. Data is 8 bits/no parity as is the ABS. format and might be ASCII text (bit 7=0) or relocatable object code etc..Length of data part of record is given in LN. |

The length field specifies from 1 to 256 bytes in the data field, but it is given the following meanings:

| <u>LN (length) field</u> | <u>Actual data block length (bytes)</u> |
|--------------------------|---|
| 1 to 255 | 1 to 255 |
| 0 | 256 |

This is so that the value of the length field corresponds with the actual number of bytes transferred, but also so that the records may be an even $\frac{1}{2}$ K block maximum. The seemingly special case of zero length (0 LN) field for a 256 byte data block is actually natural, since it represents the overflow condition (100H with the 1 dropped). It is easy to write program loops which work with this definition with no special logic to detect the 256 byte case.

Checksums are applied to both the header and the data block separately. The checksum is the negative sum of the bytes preceding it. When it is added to the preceding bytes by a loader, the result should be zero. A valid header must have a correct checksum, or it will be ignored. If a data block following a valid header has a bad checksum, a checksum error is generated and loading of the file stops until the erroneous record can be re-read correctly. Record types without data blocks do not need a second checksum following the header checksum. Header checksums do not include the SYNC characters or the SOH character.

Records on a magnetic tape are separated by an inter-record-gap or IRG of sufficient length that the tape may be stopped between records and restarted without loss of the next record. This is to allow controlled loading and storing of data to match the processing speed of a program. Records may be stored in immediately successive positions on a tape for the ABSOLUTE type record if it is not desired to read the data back slowly under program control. In this case, data can, and must be loaded back into RAM directly, at full speed.

APPENDIX G. GLOSSARY OF TERMS

- awareness** the condition of knowing in a given program that a certain system variable can and should be changed to a certain value without dangerous effects. An assembler, for example, should change no system variables - it is completely "unaware". This way, an "aware" program, called a supervisor, can run the assembler with the system RAM configured any way desired. The assembler could be used to communicate with any physical device that the supervisor desires, merely by letting the supervisor put the address of the physical device's driver routine into the appropriate wormhole.
- filter program** A program which can be installed in a wormhole by putting its address in that wormhole, and which performs some intermediate processing on I/O information before passing it on to its intended destination. An example is a pager for the listing generated by an assembler. The pager would be installed in a wormhole by a supervisor, and then the assembler would be called. The assembler would proceed unaware that the pager was counting lines and leaving spaces on each page for a page number that it generates also. The pager would pass the paged text listing on down to the physical device driver routine that was originally in the wormhole. Filter programs are also "unaware", as are user programs, since they do not know what physical device they are filtering. They depend on a supervisor to install them.
- ISR or Interrupt Service Routine** A program which executes each time a specific interrupt of the 7 possible interrupts - occurs. It usually communicates with a physical device and moves data between the device and a buffer area in RAM which is shared by the ISR and the wormhole program. which will transfer the data on to the user. The ISR also zeroes a flag byte, also in a shared (thus standardized) location. The wormhole program simply waits for this flag to be zeroed, and when it is, it knows that the data has been placed in the associated

CASSETTE TAPE FORMAT CRITERIA

Characteristics of the medium

1. fixed speed of character transfer
2. operator cannot visually identify position of tape to find leaders or identify files
3. cassettes are long enough for many files
4. no position control is available other than start/stop without operator intervention. The operator, however does not know what is coming from tape, and cannot perform positioning functions accurately, so he is of limited value.

Format criteria

1. Transfer speed regulatable over long term for program controlled acceptance of data input or output.
2. Read error recovery--operator assistance acceptable on error detection, but it must be possible to skip already read data. This makes direct loading into memory for binary object code tapes faster since an error does not mean the entire tape must be reread. Also makes buffered transfers recoverable because previous data may not be available.
3. Files identifiable by the machine so that tape libraries are possible and files may be packed closely together.
4. Contents of tape should be made visible to operator so he can scan a tape and find a file or a blank space or so he will know what portion of a file has loaded etc...
5. Multiple file types should be available for special kinds of data such as absolute binary object code, which should be loaded directly into memory, documentation or "comment" files, which should be displayed for the operator, ASCII or binary data which is to be operated on by a program of some kind and therefore should be transferred through a buffer.
6. Synchronous or asynchronous byte format should be usable with no change in the file format
7. Any transmission speed should be usable
8. Format should work on a teletype or floppy disk as well as cassette tape.
9. High efficiency in information packing for fast data rate.

APPENDIX E. MEMORY MAP

Total address space allocation.

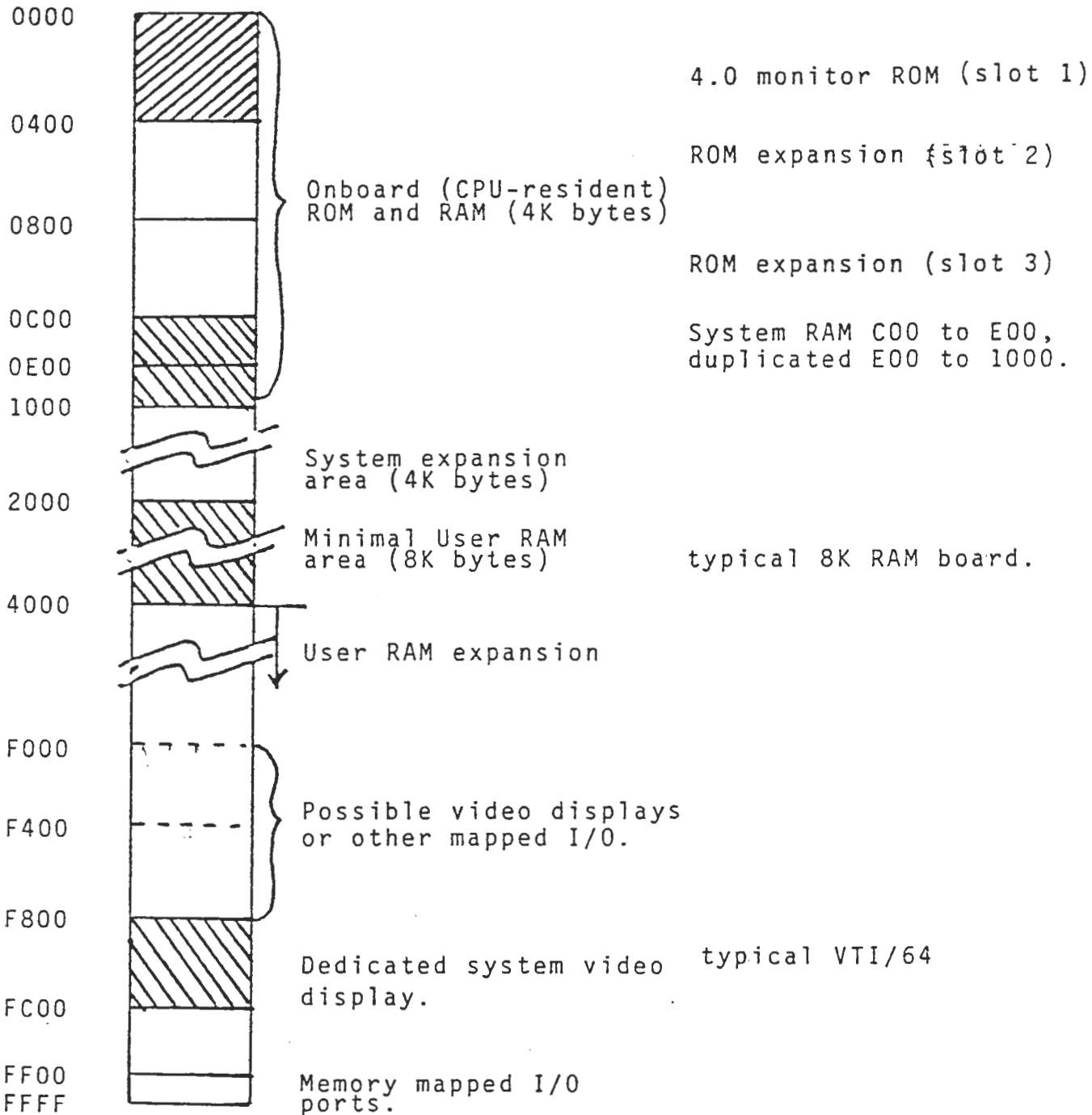

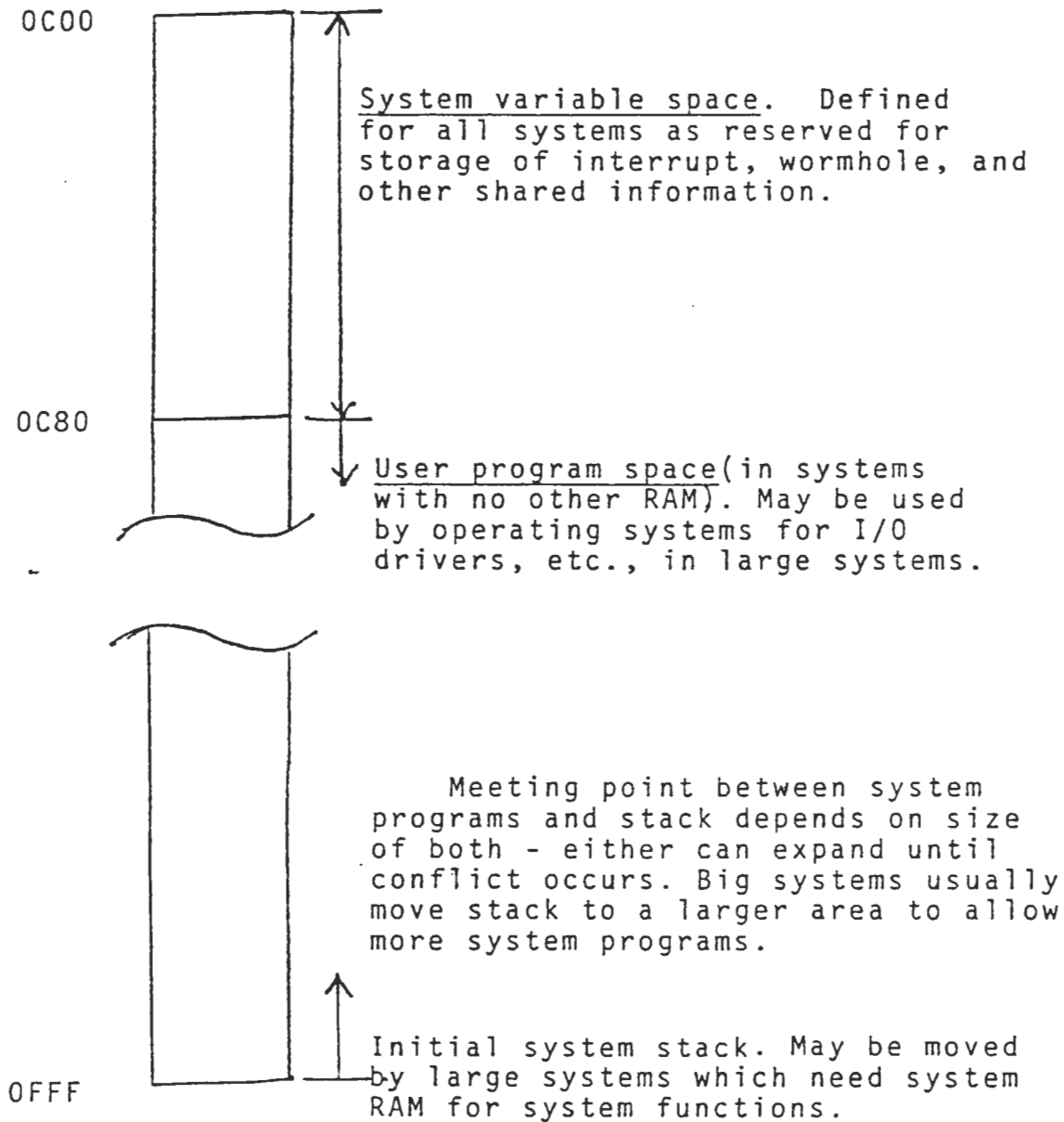
CPU resident system RAM.

System variables in System RAM.

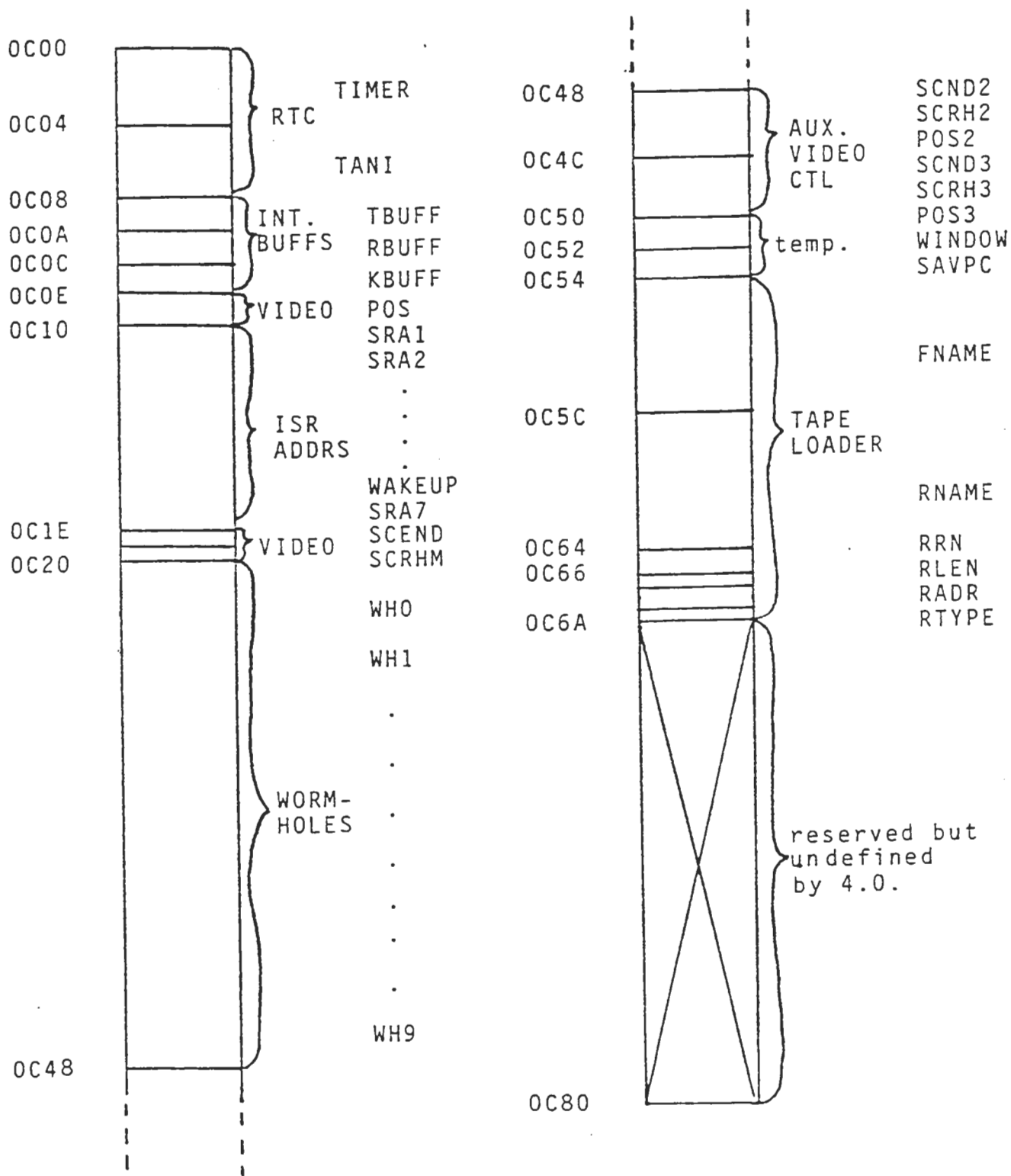

buffer. When the wormhole program is done, it de-activates the flag by putting a non-zero value in it. Interrupts occur at random times, so they must save the contents of all CPU registers and restore them when done.

link program

A part of a supervisor program which connects a filter program to the physical devices that the filter program replaced. It is installed in the appropriate wormhole by the supervisor program before the user program is executed. When the user program calls the filtered wormhole, the link program is executed. The link program restores the wormhole to its original contents and calls the filter program. The filter program executes, transferring filtered data to and from the original source/sink. When it returns, the link program restores its own address into the wormhole and returns into the user program. When the user program is finished, it returns back into the supervisor program which restores the original contents of the wormhole which had the link program address. It is evident (with thought) that a supervisor program may act as a link program for a supervisor above it, and that a link program is a simple-minded supervisor program.

logical device

An imaginary I/O device which behaves in a known way for a program which communicates with it. For example, the unknown device which communicates with the computer operator is called the logical console device. It can be used by an program without regard to what physical device is actually being used for communications with the operator (video display, TTY, graphics CRT, etc....). This means that the logical devices must be standardized: methods of access must be uniform, and the conceptual function of each device must be uniform. Standardization is achieved in the POLY-88 by such means as the use of wormholes and the declaration of conventions for allocation of system variables in the CPU resident RAM memory.

- physical device An actual piece of hardware capable of performing input or output or both, via some standard method or format. It is used to describe the difference between the data sources/sinks that an executing program is "aware" of (see glossary definition of "awareness") and the data sources/sinks that are actually being used. Programs are normally concerned with "logical devices" (e.g. "logical tape reader" or "logical console key board"), whereas the system and the computer operator are concerned with the actual physical device that data is flowing to (e.g. audio cassette or paper tape reader).
- supervisor program Any program which changes the contents of any wormhole or other system variable in the CPU resident RAM is acting as a supervisor to all programs which use the system in the new context (see dictionary definition of context). The supervisor is responsible for saving the old contents of the system RAM that it changes, and for restoring it when its job is done. It executes a CALL to the "user" program it is supposed to run. When the user program is finished, it will return and the supervisor can restore the system RAM. Supervisor generally discover how to change the system RAM by talking to the operator through the system console.
- system variables Any of the shared storage areas in the CPU resident RAM memory from C00H to C80H. System variables are used to "configure" the system because they control the connections of physical to logical devices through the wormholes, the address of current system video display and system keyboard, the addresses of auxiliary video displays, the addresses of the interrupt service routines for each interrupt, and the status of the real time clock.
- user program A completely unaware program. It is designed to perform some processing function and so should be maximally flexible in its I/O. For this reason, it does not change any system variable, but assumes that any system variables that it references have been set up properly by a supervisor before hand. When it is done, it returns with a RET instruction and the supervisor that called it restores the system variables it changed or runs another user program

- wormholes One of 10 areas in the CPU resident RAM memory that contain CALL followed by RET instructions. The address of the CALL is the address of a routine which can fetch or transmit a single byte from/to a physical device. Each wormhole is defined to be the access port for a given logical device such as the console input, console output or binary input or output etc.. The wormholes start at 0C20H and go up, each taking 4 bytes. Each can be called and will transmit/fetch the character in A. See Appendix H for details.
- wormhole programs A program called by a wormhole which is supposed to communicate with a logical device such as the logical console input device. In an interrupt driven system, it usually wastes time waiting for a flag in a known RAM location to indicate that data is available or can be transmitted to the physical device currently connected. When the flag is activated, the transfer takes place and the wormhole program returns to the user via the wormhole. The wormhole program thus guarantees that exactly one byte will be transmitted before it returns to the user. No registers other than the accumulator may be affected.

APPENDIX I

ASCII CONTROL CHARACTER USAGE

| HEX | ASCII | CTL KEY | USE |
|-----|-------|------------|--|
| 00 | NUL | @ | USED TO DETECT BREAK CONDITION |
| 01 | SOH | A | |
| 02 | STX | B | |
| 03 | ETX | C | |
| 04 | EOT | D | |
| 05 | ENQ | E | |
| 06 | ACK | F | |
| 07 | BEL | G | |
| 08 | BS | H | BACKSPACE |
| 09 | HT | I | HORIZONTAL TAB |
| 0A | LF | J | LINE FEED (NOT RECOGNIZED BY CRT DRIV.) |
| 0B | VT | K | VERTICAL TAB - MOVES CURSOR TO HOME POS. |
| 0C | FF | L | FORM FEED - CLEAR SCREEN ON CRT |
| 0D | CR | M | CARRIAGE RETURN - NEWLINE ON CRT |
| 0E | SO | N | |
| 0F | SI | O | |
| 10 | DLE | P | |
| 11 | DC1 | Q | |
| 12 | DC2 | R | |
| 13 | DC3 | S | |
| 14 | DC4 | T | |
| 15 | NAK | U | |
| 16 | SYN | V | SYNC CHARACTER - IGNORE EXCEPT AS BCC |
| 17 | ETB | W | |
| 18 | CAN | X | CANCEL LINE |
| 19 | EM | Y | KEYBOARD INTERRUPT |
| 1A | SUB | Z | SAVE CPU STATE & GO TO MONITOR |
| 1B | ESC | [| HALT EXECUTION & RETURN TO INTERPRETER |
| 1C | FS | \ | |
| 1D | GS |] | |
| 1E | RS | ↑(^) | |
| 1F | US | →(-) | |
| >F | DEL | RB | RUBOUT - DELETE LAST CHARACTER AND BACKSPACE |

APPENDIX J. VECTOR INTERRUPT SYSTEM

Interrupts on 4.0 vector through the locations from zero through 38 hex as they do in any 8080 system, however these locations in the monitor ROM contain instructions which push all general registers and jump to an address stored in the corresponding element in the SRA table (Service Routine Address table). The SRA table is in System RAM, so can be changed by a user supervisor program which wants to install its own Interrupt Service Routine (ISR) into any of the vectors. The chart below shows the history of the vectoring for each of the monitor versions. 4.0 fixes permanently the address of the SRA table at C10. Note that there is no SRA6, but instead an address known as the "wakeup" address, which is the jump address for RTC timeout. The RTC acts like a piece of hardware which increments the negative count in TIMER (four bytes at C00) until it reaches zero, when the routine at the WAKEUP address is jumped to.

| VECTORED INTERRUPT | EQUIVALENT RESTART INSTRUCTION | INTERRUPT VECTOR ADDRESS ASSIGNED BY MONIIOR VERSION | | |
|------------------------|--------------------------------------|--|------|--------------|
| | | 2.0 | 2.2 | 4.0 |
| VI0 sing.step. | RST 7 | N.A. | N.A. | C1C (SRA7) |
| VI1 RTC | RST 6 | 1030 | 0FFC | C1A (wakeup) |
| VI2 KBD | RST 5 | N.A. | N.A. | C18 (SRA5) |
| VI3 USART | RST 4 | 1020 | 0FF9 | C16 (SRA4) |
| VI4 | RST 3 | 1018 | 0FF6 | C14 (SRA3) |
| VI5 | RST 2 | 1010 | 0FF3 | C12 (SRA2) |
| VI6 | RST 1 | 1008 | 0FF0 | C10 (SRA1) |
| VI7 (same as RESET) | RST 0 | Used to initialize the system | | |

The service routine should use the original flag byte and single byte buffer that KSR (Keyboard Service Routine) used for the VTI keyboard port. If it does not, the address in the console input wormhole should be changed to point to a routine which can communicate with the proper flag and buffer. The flag and buffer used by KSR is called KBUFF and is located at COC, with the flag byte at that address, followed by the buffer. The flag indicates data is valid in the buffer when it is zero.

If it were desired to connect multiple keyboards to the system, this could be done either by using more interrupt vectors, assigning a separate service routine to each, or it could be done by doing "polled" I/O to determine which keyboard interrupted through a shared interrupt. Polling requires an interrupt service routine which can talk separately to each keyboard port to find the one that interrupted, and then service only that one. It puts the data obtained into a buffer corresponding to the interrupting keyboard and activates (zeroes) the corresponding flag. In a time sharing system, the operating system would swap addresses into and out of the console input wormhole (WHO) each time a user's program was restarted. Each user's wormhole would effectively contain a special routine which would communicate only with the buffer corresponding to his keyboard.

The monitor provides a routine which reads from the USART, and which uses another buffer of the same configuration as the keyboard buffer. It is called RBUFF and is located at COA in system RAM. When a higher-level program installs routines which can both read and write through the USART, they should use the buffers and flags defined in system RAM, just as the keyboard service routine did with the keyboard buffer. This way, all wormhole programs which wait for the flags to go to

zero will work no matter what interrupt service routine actually changed the flag. The ISR may be handling more than one device on the particular interrupt that it is installed in, and may be placing the characters it obtains into a long buffer (longer than the single byte buffer used to talk to the wormhole programs), but in any case, if the same flag and byte-buffer are used, no incompatibilities between ISR and wormhole program will result.

The key board flag is particularly important, since many large applications programs may test it to determine whether a key has been pressed. If different ISR's use different flags, then these applications programs will not work.

On the subject of standards, the interrupts service routines all use a standardized register save sequence, which consists of pushing PSW (accum and flags), then B, D, and H. All interrupts are forced to use the sequence because it is done automatically in the ROM before the ISR is jumped to. For the convenience of the ISRs, a section of code in the monitor called IORET can be used to restore all the registers in the same sequence, and to enable interrupts before returning to the interrupting program. A simple jump into the start of IORET will do the rest. In the monitor, the USART ISR, called USRTSR falls through into IORET to avoid the need to jump.

There are only seven vector interrupts because the location that V17 would interrupt through is the same address as RESET uses, specifically, address 0000. V17 would have the same effect as resetting the CPU, which of course initializes the system and brings up the tape loader mode.

Several of the other VI's have been dedicated also. They are allocated by 4.0 for the single step interrupt, the system keyboard and the 8251 USART (in addition to the RTC interrupt mentioned above).

The single step interrupt is generated by a few flip-flops on the CPU which count two instructions after they are activated and then interrupt. This allows the single stepping feature on the POLY-88 which is so useful in program debugging. The monitor pops the values of the registers from their save area on the system stack, leaving the address to be stepped, activates the single-step hardware, and does a return. The RET instruction is counted by the hardware as one instruction, then the single instruction in the user program that gets executed is counted as another before the interrupt is generated. The interrupt is vectored to SAVE - an address in the monitor - by SRA7, which is initialized to contain this address. SAVE then pushes all the registers back down the stack and returns to the front panel mode for further operator commands. 4.0 leaves the vector address of VIO changeable through SRA7 in order to use the single-stepping feature in more advanced program debugging systems.

The sytem keyboard interrupt is initially set up for a VTI keyboard port, but by changing the address in SRA5, any other interrupt serviced physical device service routine may be installed.

Appendix A

Graphics Capability & Graphics Character Set

1.0 Graphics

The PolyMorphic Systems Video Terminal Interface includes full graphics display.

When a screen location is part of a graphics display, it is subdivided into six parts, thus:

| | |
|---|---|
| 5 | 2 |
| 4 | 1 |
| 3 | 0 |

Each of the six "cells" of the screen location correspond to one bit in the byte stored in the screen location. The "zero bit" corresponds to cell 0, etc.:

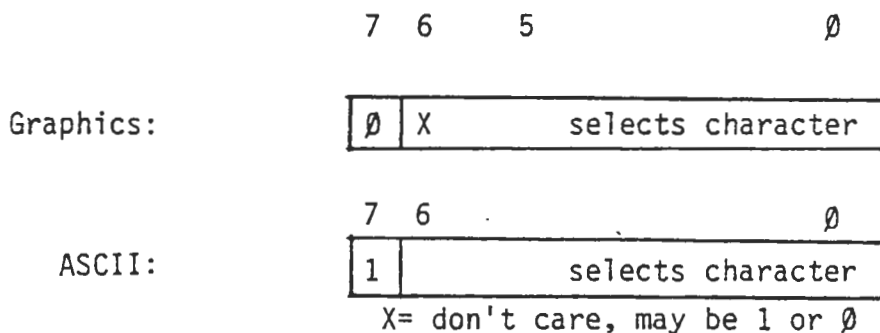

0 is "on" or "bright," 1 "off" or "dark." Thus, storing 01101010B (6AH) at a screen location produced this graphic at that location:



(Note: The graphics display utilizes the entire screen location, including the border area, which is kept dark to provide space around other characters.)

Graphics Character Set

Graphic (white bright, black dark)

100

ex

decimal

00
0



08
8



10
16



18
24



01
1



09
9



11
17



19
25



02
2



0A
10



12
18



1A
26



03
3



0B
11



13
19



1B
27



04
4



0C
12



14
20



1C
28



05
5



0D
13



15
21



1D
29



06
6



0E
14



16
22



1E
30



07
7



0F
15



17
23



1F
31



lix

Con't

20
32



28
40



30
48



38
56



21
33



29
41



31
49



39
57



22
34



2A
42



32
50



2A
58



23
35



2B
43



33
51



3B
59



24
36



2C
44



34
52



3C
60



25
37



2D
45



35
53



3D
61



26
38



2E
46



36
54



3E
62



27
39



2F
47



37
55



3F
63



POLY 88 RESIDENT MONITOR VERSION 4.0 11/22/76
COPYRIGHT 1976 INTERACTIVE PRODUCTS CORPORATION
4.0S PAGE 01

```
;
;FINAL VERSION 4.0 MONITOR NOV 22,1976
;
;COPYRIGHT 1976 BY
;POLYMORPHIC SYSTEMS
;A DIVISION OF
;INTERACTIVE PRODUCTS CORPORATION
;737 S. KELLOGG AVE.
;GOLETA, CA 93017
;
;***** 4.0 MONITOR *****
;
;WRITTEN BY          D.L.FAIMAN
;                   D.W.SALLUME
;                   R.L.DERAN
;
;POLY-88 RESIDENT MONITOR ROM VERSION 4.0.  RUNS FROM 00
;TO 3FFH IN FIRST CPU ROM SOCKET.  FRONT PANEL RESET OR
;THRU ZERO GETS A "POLY-FORMAT" ABSOLUTE TAPE LOADER
;WHICH WILL RUN THE CPU RESIDENT USART TO READ BYTE-STAN
;('B') OR "POLY-PHASE" ('P') AUDIO CASSETTE TAPES.
;CONTROL-Z AT ANY TIME ON SYSTEM KBD BRINGS UP FRONT PAN
;DISPLAY WITH MEMORY MODIFY WINDOW IN HEX.  COMMANDS THE
;ALLOW MEMORY,REGISTER MODIFICATION AND SINGLE-STEP/EXEC
;OF INTERRUPTED PGM.
;
;UTILITY PGMS AVAILABLE FOR USER ARE:
;DSPLY  PUTS CHAR ON SYSTEM VIDEO SCR.  RECOGNIZES
;        ALL STANDARD CTL CHARS AND SCROLLS TEXT UP.
;        ACCESSIBLE BY CALL TO WORMHOLE 1 (WH1) AT 0C24H.
;KI     GETS CHAR FROM SYSTEM CONSOLE KBD.
;        ACCESSIBLE BY CALL TO WORMHOLE ZERO (WH0) AT 0C2
;USRTI  GETS CHAR FROM USART BACKGROUND LOAD
;        TYPE ROUTINE.
;HEXO   PUTS OUT LOW NIBBLE OF A IN HEX THRU WH1
;BYTE   PUTS OUT A IN HEX THRU WH1.
;DEOUT  PUTS OUT D,E IN HEX THRU WH1.
;HEXC   GETS A HEX NUMBER UP TO 2 BYTES LONG IN H,L FROM
;        WH0, ECHOING ON WH1.  NON-HEX CHARACTER
;        TERMINATES INPUT.  THE TERM. CHAR IS LEFT IN A.
;MOVE   TRANSFERS #BYTES IN BC FROM ADDR IN HL TO ADDR I
;        TERMINATES WITH HL=HL+BC,DE=DE+BC,BC=0.
;IORET  A SECTION OF CODE THAT TERMINATES AN
;        INTERRUPT SERVICE ROUTINE BY RESTORING
;        ALL REGS IN STANDARD ORDER, EI, RET.
;TIME   EXECUTES 60 TIMES A SECOND AUTOMATICALLY, INCREM
;        ING FOUR BYTE LOCATION CALLED TIMER.  IF TIMER=0
;        ALL REGS SAVED AND ROUTINE AT ADDR IN LOCATION
;        WAKEUP IS JUMPED TO.  THIS ROUTINE MAY TERMINATE
```

```

;          BY USING IORET.
;
;*****SYSTEM RAM ALLOCATION*****
;
;DEDICATED LOCATIONS.
;
0C00          ORG          0C00H      ;BEGIN OF ONBD RAM
0C00          TIMER:    DS          4      ;INCREMENTED BY 60HZ CLOCK.
;LOW BYTE=LEAST SIGNIFICANT.
0C04          TANI:     DS          4      ;TIME AT NEXT INT. USED BY
0C08          TBUFF:    DS          2      ;USART TRANSMIT BUFFER
;FLAG AND ONE BYTE BUFFER.
;USED BY EXTERNAL DUMPERS.
0C0A          RBUFF:    DS          2      ;USART RECEIVE BUFFER FLAG
;AND ONE BYTE BUFFER.
;USED BY MONITOR TAPE LOADER.
0C0C          KBUFF:    DS          2      ;KBD BUFF-FULL FLAG AND BUFFER
0C0E          POS:      DS          2      ;CURSOR POSITION FOR DSPLY
;INTERRUPT SERVICE ROUTINE ADDRESS TABLE.
0C10          SRA1:     DS          2      ;VI7
0C12          SRA2:     DS          2      ;VI6
0C14          SRA3:     DS          2      ;VI5
0C16          SRA4:     DS          2      ;VI4: USART INT.,FIRST INITED SR
0C18          SRA5:     DS          2      ;VI3: KBD INT.
0C1A          WAKEUP:   DS          2      ;ADDRESS JUMPED TO WHEN CLOCK TI
;OUT IS IN THIS LOC. IT FUNCTION
;EXACTLY LIKE AN SRA, BUT IS ACT
;JUMPED TO BY THE CLOCK SOFTWARE
;EFFECTIVELY SIMULATES A HARDWAR
0C1C          SRA7:     DS          2      ;SINGLE-STEP INTERRUPT. NORMALLY
;AT ITS INITED ADDR WHICH BRINGS
;UP FRONT PANEL DISPLAY. IT CAN
;CHANGED FOR EXTRNAL PGMS TO USE
;DEBUGGING OR FANCY PGMING.
;VIDEO SCREEN ADDRESS PARAMETERS USED IN DSPLY.
;INITED TO F800H,FCH, BUT MAY BE CHANGED AFTER
;SYSTEM START UP.
0C1E          SCEND:    DS          1      ;SCREEN END FOR DSPLY.
0C1F          SCRHM:    DS          1      ;SCREEN HOME FOR DISPLAY
;WORMHOLE VECTOR. THIS TABLE IS FULL OF CALL-RETURN PAIR
;WHICH CALL SYSTEM I/O PROGRAMS. THEY MAY BE CHANGED AFT
;INITIALIZATION TO CALL ANY PHYSICAL DEVICE DRIVER IT IS
;DESIRED TO INSTALL. THIS IS NORMALLY DONE WITH LINK PR
;AS DESCRIBED IN MANUALS. THE FIRST TWO WORMHOLES ARE I
;TO THE SYSTEM CONSOLE KBD AND SYSTEM VIDEO DISPLAY.
;ALL USER I/O SHOULD BE DONE THRU THE WH'S TO INSURE
;COMPATIBILITY WITH ANY SUPERVISOR SYSTEM AND TO ALLOW
;DYNAMIC REASSIGNMENT OF I/O FOR A FIXED USER OBJECT PGM
0C20          WH0:      DS          4      ;CONSOLE IN: INITED TO CALL SYS.
0C24          WH1:      DS          4      ;CONSOLE OUT: INITED TO CALL DSP
0C28          WH2:      DS          4      ;SYSIN: USED EXTRNLY BY TAPE OR
;INPUT DRIVERS. A CALL GETS BYTE
FFEA          INITLEN EQU          SRA4-$ ;LENGTH OF INITIALIZED MEMORY
0C2C          WH3:      DS          4      ;SYSOT: USED BY TAPE OR DISK OUT

```

```

                                ;DRIVERS. A CALL OUTPUTS BYTE IN
0C30      WH4:      DS          4      ;SYSIN2: SECONDARY SYSTEM INPUT.
0C34      WH5:      DS          4      ;SYSOT2: SECONDARY SYSTEM OUTPUT
0C38      WH6:      DS          4      ;READ: TEXT TYPE INPUT USED
                                ;BY EXTRNL TAPE,DISK,KBD DRIVERS
0C3C      WH7:      DS          4      ;LIST: TEXT TYPE OUTPUT TO LINE
                                ;PRINTERS OR TEXT FILES ETC.
0C40      WH8:      DS          4      ;AUX WH: IN
0C44      WH9:      DS          4      ;AUX WH: OUT
                                ;VCB BLOCKS TO BE TEMPORARILY SWAPPED FOR SCRHM,SCEND AN
                                ;IN ORDER TO USE DSPLY ON OTHER THAN SYSTEM VIDEO DISPLA
                                ;A LINK PGM DOES SWAPPING, AND IS CALLED FROM WH1 IN-
                                ;STEAD OF DSPLY. IT THEN CALLS DSPLY, AND RESTORES
                                ;CONTENTS OF SCRHM,SCEND AND POS BEFORE RET..
                                VCB2:      ;SECONDARY VDO SCRNM CONTEXT
0C48      SCND2:    DS          1
0C49      SCRHM2:   DS          1
0C4A      POS2:     DS          2
                                VCB3:      ;TERTIARY VDO SCRNM CTX.
0C4C      SCND3:    DS          1
0C4D      SCRHM3:   DS          1
0C4E      POS3:     DS          2
                                ;
                                ;TEMPORARY LOCATIONS USED BY FRONT PANEL MODE.
                                ;
0C50      WINDOW:  DS          2      ;MEM. MODIFY WINDOW POINTER.
0C52      SAVPC:   DS          2      ;USED BY S.S.WHEN STACK UNAVAILA
                                ;
                                ;TEMPORARY LOCATIONS USED BY TAPE LOADER.
                                ;
0C54      FNAME:   DS          8      ;"FIND" NAME FOR TAPE LOADER.
0C5C      RNAME:   DS          8      ;READ RECD NAME -FOUND ON TAPE.
0C64      RRN:     DS          2      ;READ RECD NUMBER.
0C66      RLEN:    DS          1      ;READ RECD LENGTH.
0C67      RADR:    DS          2      ;READ RECD ADDR (BIAS).
0C69      RTYPE:   DS          1      ;READ RECD TYPE.
                                ;FREE ONBOARD RAM ONWARDS.
                                ;
                                ;***MONITOR PROGRAM***
                                ;
                                ;VECTOR INTERRUPT LOCATIONS
0000      ORG      0
0000 310010  RESET:  LXI      SP,STACK ;FRNT PANEL RST OR POWER UP GET
0003 C30002  JMP      RST1   ;RST1 INITS SYST RAM,ENDS IN TAP
                                ;
                                ;THESE TWO INSTRUCTIONS CAN BE CALLED TO GET THE
                                ;ADDRESS OF THE CALLING PROGRAM INTO H,L. THIS
                                ;IS NECESSARY IN WRITING SELF RELOCATING CODE.
                                ;
0006 E1      POP      H
0007 E9      PCHL
0008 F5      VI6:    PUSH     PSW      ;STANDARD REGISTER PUSH SEQUENCE
0009 C5      PUSH     B
000A D5      PUSH     D

```

```

000B E5          PUSH      H
000C 2A100C      LHL D    SRA1    ;GET SERVICE ROUTINE ADDRESS
000F E9          PCHL
0010 F5          VI5:    PUSH     PSW    ;GO EXECUTE IT. IT WILL RTRN THR
0011 C5          PUSH     B      ;SAME AS ABOVE
0012 D5          PUSH     D
0013 E5          PUSH     H
0014 2A120C      LHL D    SRA2
0017 E9          PCHL
0018 F5          VI4:    PUSH     PSW
0019 C5          PUSH     B
001A D5          PUSH     D
001B E5          PUSH     H
001C 2A140C      LHL D    SRA3
001F E9          PCHL
0020 F5          VI3:    PUSH     PSW
0021 C5          PUSH     B
0022 D5          PUSH     D
0023 E5          PUSH     H
0024 2A160C      LHL D    SRA4
0027 E9          PCHL
0028 F5          VI2:    PUSH     PSW
0029 C5          PUSH     B
002A D5          PUSH     D
002B E5          PUSH     H
002C 2A180C      LHL D    SRA5
002F E9          PCHL
0030 F5          CLOCK:  PUSH     PSW    ;THE CLOCK INT ALWAYS GOES TO TH
0031 C5          PUSH     B      ;TIMER COUNTER ROUTINE.
0032 D5          PUSH     D
0033 E5          PUSH     H
0034 C34000      JMP      TIME
0037 00          DB      0
0038 F5          SS:    PUSH     PSW
0039 C5          PUSH     B
003A D5          PUSH     D
003B E5          PUSH     H
003C 2A1C0C      LHL D    SRA7
003F E9          PCHL
0040 D308        TIME:    OUT     8      ;ENABLE INT FOR NEXT 60HZ CYCLE
0042 21000C      LXI     H,TIMER ;COUNTER LOCATION
0045 3E04        MVI     A,4     ;4 BYTES TO INCR
0047 34          TIME2:  INR     M      ;INC ONE LOC.
0048 C26400      JNZ     IORET  ;DONE,STANDARD RETURN
004B 23          INX     H
004C 3D          DCR     A
004D C24700      JNZ     TIME2
0050 2A1A0C      LHL D    WAKEUP ;CNTR IS ZERO,SO INITIATE WAKEU
0053 E9          PCHL    ;GO TO THE WAKEUP TASK
;USART INTERRUPT SERVICE ROUTINE FOR INPUT
;ITS ADDRESS IS INITED INTO SRA4.
0054 DB01        USRTSR: IN     1
0056 E602        ANI     2
0058 CA6400      JZ      IORET

```



```

005B DB00          IN      0
005D 210A0C       LXI     H,RBUFF
;
;THIS CODE IS SHARED BY ANY SERVICE ROUTINE
;WHICH HAS FOUND A CHARACTER. HL SHOULD HAVE THE
;BUFFER ADDRESS, FLAG FIRST-THEN ONE BYTE BUFF.
;ONLY USED BY INPUT ISR'S.
;
0060 3600       IOPUT:  MVI     M,0      ;ZERO THE FLAG: WE GOT THE CHAR
0062 23         INX     H              ;MOVE UP TO DATA BUFFER
0063 77         MOV     M,A          ;PUT CHAR IN DATA BUFF
;FALL THRU TO IORET
0064 E1         IORET:  POP     H              ;THIS CODE SECTION CAN BE JUMPED
;FOR STANDARD SEQ.REG.POPS AND E
;AS FOR ANY INTERRUPT SERVICE RT
0065 D1         POP     D
0066 C1         POP     B
0067 F1         POP     PSW
0068 FB         EI
0069 C9         RET
;WORMHOLE END OF KBD CHAR FETCH RTNS.
;WHEN CALLED BY WH0,WAITS FOR VALID DATA FLG IN KBUFF,
;THEN RETURNS CHAR FROM KBUFF+1 IN A.
006A E5         KI:     PUSH    H          ;WE CAN ONLY WRECK A, SO SAVE H
006B 210C0C       LXI     H,KBUFF
006E 7E         KI1:   MOV     A,M          ;GET FLAG
006F B7         ORA     A              ;IS IT ZERO?
0070 C26E00       JNZ     KI1          ;NO,TRY AGAIN
0073 35         DCR     M
0074 23         INX     H
0075 7E         MOV     A,M
0076 E1         POP     H
0077 C9         RET
0078 E5         USRTI:  PUSH    H
0079 210A0C       LXI     H,RBUFF
007C C36E00       JMP     KI1
;
;***** VIDEO DISPLAY DRIVER *****
;
;DSPLY IS THE FAMOUS "TELETYPE SIMULATOR" WHICH
;DRIVES A POLYMORPHICS VTI AND SCROLLS TEXT WHEN
;THE SCRNM FILLS. IT RECOGNIZES ALL IMPORTANT CONTROL
;CHARACTERS AND USES THE SCRHM,SCEND, AND POS LOCATIONS
;IN SYSTEM RAM WHICH ARE INITIALIZED TO GIVE A SCREEN
;AT 0F800H TO 0FBFFH ON POWER-UP OR FPRST. AT
;THE SAME TIME, ITS OWN ADDRESS IS PUT IN WH1 FOR THE
;DEFAULT SYSTEM CONSOLE DISPLAY DRIVER.
;
007F F5         DSPLY:  PUSH    PSW        ;A WH PGM MUST SAVE ALL REGS
0080 C5         PUSH    B
0081 D5         PUSH    D
0082 E5         PUSH    H
0083 2A0E0C       LHLD   POS
0018          CTLX    EQU     18H        ;ASCII "CAN" CLEARS CUR. LINE

```

```

0086 FE18          CPI      CTLX
0088 CAD000       JZ       CLINE
008B 11B900      LXI      D,SCRL ;ALL DSPLY CHARACTER
008E D5          PUSH     D      ;HANDLING SUBROUTINES EXCEPT
                                ;CLINE RETURN TO SCRL TO CHECK
                                ;SCRN OVERFLOW AND SCROLL
                                ;IF NECESSARY.
008F 367F          MVI      M,07FH ;BLANK THE CURSOR SO WE
                                ;WON'T HAVE TO LATER.
                                ;USE A GRAPHICS BLANK
                                ;INSTEAD OF A SPACE.
007F              RB      EQU      7FH ;ASCII "DEL" OR RUBOUT
                                ;BACKSPACE AND DELETE CHAR.
0091 FE7F          CPI      RB
0093 CAE400       JZ       RBR
0096 FE20          CPI      20H ;IF CHAR IS ABOVE 20H, PRINT IT
0098 D2B400      JNC      NORM ;ELSE IT'S NOT A NORMAL CHAR,
                                ;SO TEST IT FOR VALID CTL CODE
000D              CR      EQU      0DH ;CARRIAGE RETURN. MOVES DOWN
                                ;A LINE, LEFT-ZEROES CURSOR.
009B D60D          SUI      CR
009D CAE600       JZ       CRR
000C              FF      EQU      0CH ;FORM FEED. CLEARS SCRNL, HOMES
                                ;CURSOR.
00A0 3C           INR      A
00A1 CAEF00       JZ       FFR
000B              VT      EQU      0BH ;VERTICAL TAB. JUST HOMES CURSOR
00A4 3C           INR      A
00A5 CAF900       JZ       VTR
0009              TAB     EQU      09H ;TAB. MOVES CURSOR RIGHT TO
                                ;NEXT EVEN/8 POSITION.
00A8 3C           INR      A
00A9 3C           INR      A
00AA C0           RNZ      ;IF NOT A TAB, RETURN
00AB 7D           MOV      A,L ;BACK UP CURSOR TO EVEN/8
00AC E6F8         ANI      0F8H
00AE 6F           MOV      L,A
00AF 010800      LXI      B,8 ;MOV UP 8 POSITIONS
00B2 09           DAD      B
00B3 C9           RET
00B4 F680         NORM:   ORI      80H ;WE HAVE A PRINTING CHAR, SO MAP
                                ;IT INTO CHAR AREA OF VTI SPACE.
00B6 77           MOV      M,A ;PUT IT IN REFRESH MEM.
00B7 23           INX      H ;MOVE UP A POSITION.
00B8 C9           RET      ;GO TO SCRL.
;
;SCRL SCROLLS TEXT UP THE SCRNL IF NECESSARY,
;THEN FALLS INTO CURP, WHICH RESTORES THE CURSOR
;AND RETURNS TO USER THRU IORET.
;
00B9 3A1E0C      SCRL:   LDA      SCEND
00BC BC          CMP      H
00BD C2DC00      JNZ      CURP
00C0 2A1E0C      LHL D   SCEND

```

```

00C3 7C          MOV      A,H
00C4 95          SUB      L
00C5 54          MOV      D,H
00C6 2E40        MVI      L,40H
00C8 1E00        MVI      E,0
00CA 4D          MOV      C,L
00CB 47          MOV      B,A
00CC CD0001      CALL     MOVE
00CF 2B          DCX      H

;
;CLINE CLEARS THE CURRENT LINE
;
00D0 3E3F        CLINE:  MVI      A,3FH
00D2 57          MOV      D,A
00D3 B5          ORA      L
00D4 6F          MOV      L,A
00D5 367F        WIPE:   MVI      M,7FH
00D7 2B          DCX      H
00D8 15          DCR      D
00D9 C2D500      JNZ     WIPE
00DC 36FF        CURP:   MVI      M,0FFH
00DE 220E0C      SHLD    POS
00E1 C36400      JMP     IORET
00E4 2B          RBR:   DCX      H          ;RUBOUT ROUTINE
00E5 C9          RET
00E6 014000      CRR:   LXI      B,64      ;CARRIAGE RETURN RTN.
00E9 7D          MOV      A,L
00EA E6C0        ANI     0C0H
00EC 6F          MOV      L,A
00ED 09          DAD     B
00EE C9          RET
00EF CDF900      FFR:   CALL     VTR      ;FORM FEED ROUTINE
00F2 367F        FF1:   MVI      M,7FH
00F4 23          INX     H
00F5 BC          CMP     H
00F6 C2F200      JNZ     FF1
00F9 2A1E0C      VTR:   LHLD    SCEND    ;VERTICAL TAB RTN.
00FC 7D          MOV      A,L
00FD 2E00        MVI     L,0
00FF C9          RET

;
;MOVE MOVES -BC BYTES FROM THE AREA STARTING AT
;(HL) TO THE AREA STARTING AT (DE)
;
0100 7E          MOVE:  MOV      A,M
0101 12          STAX   D
0102 13          INX     D
0103 23          INX     H
0104 0C          INR     C
0105 C20001      JNZ     MOVE
0108 04          INR     B
0109 C20001      JNZ     MOVE
010C C9          RET

```

;

```
;KEYBOARD INTERRUPT SERVICE ROUTINE FOR SYSTEM CONSOLE
;KEYBOARD AT 0F8H. ITS ADDRESS IS INITED INTO SRA5.
;IT WATCHES FOR CTL/Z. IF IT FINDS ONE, IT FALLS
;THRU INTO SAVE, THUS ENTERING FRONT PANEL MODE.
;KBD ADDR IS FIXED BY SCREEN ADDR, WHICH IS 0F800H
;SINCE A POLYMORPHIC VTI USES SAME DECODER FOR KBD
;AS FOR VIDEO REFRESH MEMORY.
```

```
010D DBF8
010F 210C0C
001A
0112 FE1A
0114 C26000
```

```
KSR: IN 0F8H
LXI H,KBUFF
CTLZ EQU 01AH
CPI CTLZ
JNZ IOPUT
```

```
;***** FRONT PANEL MODE *****
```

```
;SAVE IS THE ENTRY POINT INTO FRONT PANEL.
;MODE IF REGISTERS HAVE BEEN ALREADY PUSHED IN
;STANDARD SEQUENCE. IT PUSHES PC AND SP
;ON TOP OF REGISTERS FOR DISP TO USE.
```

```
0117 210A00
011A 39
011B E5
011C 2B
011D 56
011E 2B
011F 5E
0120 D5
```

```
SAVE: LXI H,10
DAD SP
PUSH H
DCX H
MOV D,M
DCX H
MOV E,M
PUSH D
```

```
;WARM IS THE ENTRY POINT TO FRONT PANEL MODE
;IF PC AND SP HAVE ALREADY BEEN PUSHED DOWN
;ON TOP OF REGISTERS IN STANDARD SEQUENCE
```

```
0121 CD9203
0124 FB
0125 CDF900
0128 015101
012B 09
012C 369C
012E 017501
```

```
WARM: CALL CLEAR
EI
CALL VTR ;SET HL TO BEGINNING OF SCREEN
LXI B,337 ;OFFSET FROM SCRHM FOR UPARROW
DAD B
MVI M,9CH ;VTI CODE FOR UPARROW
LXI B,175H ;OFFSET FROM UPARROW FOR
;RIGHT ARROW
```

```
0131 09
0132 369A
```

```
DAD B
MVI M,9AH ;VTI CODE FOR RIGHT ARROW
```

```
;DISP IS THE ENTRY POINT TO FRONT PANEL MODE IF
;THE SCREEN ALREADY SHOWS A FRONT PANEL DISPLAY.
;IT DOES NOT CLEAR THE SCREEN, SO WILL NOT
;BLINK WHEN SCREEN IS UPDATED.
```

```
0134 3E18
0136 CD7F00
0139 3E0B
013B CD7F00
```

```
DISP: MVI A,CTLX ;ERASE LAST COMMAND ON SCRNM
CALL DSPLY
MVI A,0BH
CALL DSPLY
```

| | | | |
|---------------|--------|------|------------------|
| 013E 3E06 | | MVI | A,6 |
| 0140 210000 | | LXI | H,0 |
| 0143 39 | | DAD | SP |
| 0144 016D01 | | LXI | B,MSG |
| 0147 F5 | | PUSH | PSW |
| 0148 37 | DISP1: | STC | |
| 0149 CD7C01 | | CALL | FLDSY |
| 014C CD7C01 | | CALL | FLDSY |
| 014F CD9703 | | CALL | BLK |
| 0152 5E | | MOV | E,M |
| 0153 23 | | INX | H |
| 0154 56 | | MOV | D,M |
| 0155 23 | | INX | H |
| 0156 CDD103 | | CALL | DECUT |
| 0159 F1 | | POP | PSW |
| 015A 3D | | DCR | A |
| 015B CA8701 | | JZ | FLAGS |
| 015E F5 | | PUSH | PSW |
| 015F C5 | | PUSH | B |
| 0160 EB | | XCHG | |
| 0161 01FDFE | | LXI | B,-3 |
| 0164 09 | | DAD | B |
| 0165 EB | | XCHG | |
| 0166 CD7F03 | | CALL | HEX08 |
| 0169 C1 | | POP | B |
| 016A C34801 | | JMP | DISP1 |
| 016D 50435350 | MSG: | DB | 'PCSPHLDEBCAFMZ' |
| 0171 484C4445 | | | |
| 0175 42434146 | | | |
| 0179 434D5A | | | |

;
 ;FIELD DISPLAY PUTS OUT CHAR IN ADDR IN B IFF CY SET.
 ;IFF CY ZERO, PUT BLANK TO VDO DISPLAY.
 ;IN EITHER CASE, B IS INCREMENTED.

| | | | |
|-------------|--------|------|--------|
| 017C F5 | FLDSY: | PUSH | PSW |
| 017D D49703 | | CNC | BLK |
| 0180 0A | | LDAX | B |
| 0181 DC7F00 | | CC | DSPLY |
| 0184 F1 | | POP | PSW |
| 0185 03 | | INX | B |
| 0186 C9 | | RET | |
| 0187 CD9C03 | FLAGS: | CALL | TABBER |
| 018A 7B | | MOV | A,E |
| 018B 0F | | RRC | |
| 018C CD7C01 | | CALL | FLDSY |
| 018F 07 | | RLC | |
| 0190 07 | | RLC | |
| 0191 CD7C01 | | CALL | FLDSY |
| 0194 07 | | RLC | |
| 0195 CD7C01 | | CALL | FLDSY |

;
 ;MMOD PLACES THE MEMORY MODIFY DISPLAY
 ;ON THE SCREEN WINDOW POINT TO THE BYTE

;TO BE MODIFIED

```

;
MMOD:  CALL    CROUT
0198  CD8D03  CALL    CROUT
019B  CD8D03  CALL    CROUT
019E  2A500C  LHL    WINDOW
01A1  01E0FF  LXI    B,-32
01A4  09      DAD    B
01A5  0E08   MVI    C,8
01A7  EB     XCHG
01A8  CDD103  MMOD1: CALL    DEOUT
01AB  CD9C03  CALL    TABBER
01AE  3E7F   MVI    A,7FH
01B0  CD7F00  CALL    DSPLY
01B3  CD7F03  CALL    HEXO8
01B6  0D     DCR    C
01B7  C2A801  JNZ    MMOD1

```

```

;
;COMD CALLS HEXC TO GET HEX NUMBERS TO BE ENTERED INTO M
;THEN EVALUATES THE NON-HEX TERMINATING CHARACTER TO SEE
;IT IS A COMMAND
;

```

```

01BA  CDAA03  COMD:  CALL    HEXC
01BD  79      MOV    A,C
01BE  B7      ORA    A
01BF  C45302  CNZ    STORE
01C2  78      MOV    A,B
01C3  213401  LXI    H,DISP
01C6  E5     PUSH   H
01C7  21E801  LXI    H,MTBL
01CA  CDD801  CALL   LOOKUP
01CD  1600    MVI    D,0
01CF  D23E02  JNC    ADDIT
01D2  CDD801  CALL   LOOKUP
01D5  D8      RC
01D6  210002  LXI    H,RTN
01D9  19      DAD    D
01DA  E9     PCHL

```

```

;
;LOOKUP COMPARES THE ACCUMULATOR
;AGAINST THE ENTRY IN A TABLE
;POINTED TO BY HL AND RETURNS WITH
;THE BYTE FOLLOWING IT IN E.
;CARRY FLAG SET IF NO MATCH
;TABLE MUST END IN 0FFH, EACH ENTRY IS 2 BYTES
;

```

```

01DB  BE     LOOKUP: CMP    M
01DC  23     INX    H
01DD  5E     MOV    E,M
01DE  C8     RZ
01DF  23     INX    H
01E0  5E     MOV    E,M
01E1  1C     INR    E
01E2  C2DB01  JNZ    LOOKUP
01E5  23     INX    H

```

01E6 37
 01E7 C9

STC
 RET

;
 ;MTBL IS THE TABLE OF COMMANDS FOR
 ;MEMORY MODIFY
 ;

| | | | | |
|---------|-------|----|------------|--------------------------------|
| 01E8 20 | MTBL: | DB | ' ' | ;SPACE MOVE POINTER FORWARD |
| 01E9 11 | | DB | 17 | |
| 01EA 08 | | DB | 8 | ;BACKSPACE MOVES BACKWARDS ONE |
| 01EB 0F | | DB | 15 | |
| 01EC 0D | | DB | 13 | ;RETURN MOVES FWD 8 BYTES |
| 01ED 18 | | DB | 24 | |
| 01EE 0A | | DB | 10 | ;LINE FEED MOVES BACK 8 BYTES |
| 01EF 08 | | DB | 8 | |
| 01F0 FF | | DB | -1 | ;END OF 1ST HALF TABLE |
| 01F1 47 | | DB | 'G' | ;GO |
| 01F2 6C | | DB | G-RTN | |
| 01F3 53 | | DB | 'S' | ;SET REGISTER |
| 01F4 7C | | DB | SETR-RTN | |
| 01F5 58 | | DB | 'X' | ;EXECUTE (SINGLE STEP) |
| 01F6 59 | | DB | X-RTN | |
| 01F7 49 | | DB | 'I' | ;INDIRECT |
| 01F8 49 | | DB | IND-RTN | |
| 01F9 54 | | DB | 'T' | ;TAPE LOADER |
| 01FA 14 | | DB | TAPE-RTN | |
| 01FB 4C | | DB | 'L' | ;LOAD MEMORY POINTER |
| 01FC 37 | | DB | LOD-RTN | |
| 01FD 4A | | DB | 'J' | ;JUMBO - LOAD 2 BYTES |
| 01FE 2C | | DB | DOUBLE-RTN | |
| 01FF FF | | DB | -1 | |

;
 ;RST1 IS THE INITIALIZATION ROUTINE
 ;IT SETS UP THE WORMHOLES USED IN THE
 ;MONITOR, THEN CHECKS FOR A SECOND ROM
 ;AND CALLS IT IF IT IS THERE
 ;

| | | | | |
|-------------|-------|------|-----------|---------------------------------|
| 0200 | RTN | EQU | \$ | ;ALL ROUTINES REFERENCE TO HERE |
| 0200 11160C | RST1: | LXI | D,SRA4 | |
| 0203 21EA03 | | LXI | H,INITER | |
| 0206 01EAFB | | LXI | B,INITLEN | |
| 0209 CD0001 | | CALL | MOVE | ;INIT WORMHOLES |
| 020C 3A0004 | | LDA | 400H | ;GET 1ST BYTE OF 2ND ROM |
| 020F 3C | | INR | A | ;IF IT WAS NOT 0FFH |
| 0210 C40004 | | CNZ | 400H | ;CALL IT |
| 0213 FB | | EI | | ;TURN ON INTERRUPTS |

;
 ;TAPE IS THE BOOTSTRAP LOADER ROUTINE
 ;IT EXPECTS TO GET A B,P, OR C OR IT WILL
 ;WAIT FOR ONE
 ;

| | | | | |
|-------------|--------|------|-------|-------------------------------|
| 0214 CD9203 | TAPE: | CALL | CLEAR | |
| 0217 CDA103 | START: | CALL | LCFLD | ;GET A CASE-FOLDED B OR P |
| 021A 4F | | MOV | C,A | ;SAVE THE B OR P FOR ECHOING. |
| 021B FE50 | | CPI | 'P' | ;POLYPHASE |

```

021D CABA02      JZ      POLY
0220 D642       SUI      'B'      ;BYTE STANDARD
0222 CAC702      JZ      BITE
0225 3D         DCR      A
0226 CAF302      JZ      HEAD      ;CONTINUE
0229 C31702      JMP      START      ;NOT A B OR C OR P : TRY AGAIN

```

```

;
;
;
;DOUBLE GETS A HEX NUMBER FROM THE CONSOLE
;AND LOADS IT INTO THE NEXT 2 BYTES IN MEMORY
;(OR A REGISTER) LOW ORDER BYTE FIRST
;J<HEX #>(CR)

```

```

022C CDAA03      DOUBLE:  CALL      HEXC
022F EB         XCHG
0230 2A500C      LHL      WINDOW
0233 73         MOV      M,E
0234 23         INX      H
0235 72         MOV      M,D
0236 C9         RET

```

```

;
;LOD LOADS WINDOW WITH THE NUMBER
;FOLLOWING THE L COMMAND
;L<HEX NUMBER>(CR)

```

```

0237 CDAA03      LOD:      CALL      HEXC
023A 22500C      SVW:      SHLD     WINDOW
023D C9         RET

```

```

;
;ADDIT MOVES THE MEMORY POINTER (WNDOW)
;BY FORWARD OR BACKWARDS BY
;THE VALUE IN E (D=0)
;E IS OFFSET BY 16

```

```

023E 2A500C      ADDIT:  LHL      WINDOW
0241 01F0FF      LXI      B,-16
0244 09         DAD      B
0245 19         DAD      D
0246 C33A02      JMP      SVW

```

```

;
;IND LOADS THE NEXT 2 BYTES IN MEMORY
;INTO WINDOW

```

```

0249 2A500C      IND:      LHL      WINDOW
024C 5E         MOV      E,M
024D 23         INX      H
024E 56         MOV      D,M
024F EB         XCHG
0250 C33A02      JMP      SVW

```

```

;
;STORE STORES THE BYTE IN L (ENTERED
;FROM CONSOLE) INTO MEMORY

```



```

0253 7D      STORE:  MOV      A,L
0254 2A500C  LHL D   WINDOW
0257 77      MOV      M,A
0258 C9      RET

;
;X EXECUTES ONE INSTRUCTION POINTED TO
;BY SAVPC AND RETURNS TO RST7
;
X:  0259 E1      POP      H          ;2 DUMMY POPS
    025A E1      POP      H          ;GET PC
    025B 22520C  SHLD   SAVPC      ;SAVE IT
    025E E1      POP      H
    025F E1      POP      H          ;GET REGISTERS
    0260 D1      POP      D
    0261 C1      POP      B
    0262 F1      POP      PSW
    0263 E3      XTHL   ;RESTORE PC
    0264 2A520C  LHL D   SAVPC
    0267 E3      XTHL
    0268 FB      EI
    0269 D30C   OUT     12          ;ENABLE SINGLE STEP LOGIC
    026B C9      RET              ;GO TO USER PGM.

;
;G ACTS THE SAME AS X BUT DOES NOT
;ENABLE SINGLE STEP LOGIC, AND
;THEREFORE DOES NOT RETURN
;TYPING CTL-Z WILL RETURN FROM THE
;PROGRAM BEING EXECUTED AND SAVE
;ALL REGISTERS
;IF A RST7 IS ENCOUNTERED THIS WILL
;ALSO HAPPEN
;
G:  026C E1      POP      H
    026D E1      POP      H
    026E 22520C  SHLD   SAVPC
    0271 E1      POP      H
    0272 E1      POP      H
    0273 D1      POP      D
    0274 C1      POP      B
    0275 F1      POP      M
    0276 E3      XTHL
    0277 2A520C  LHL D   SAVPC
    027A E3      XTHL
    027B C9      RET

;
;SETR POINTS TO ONE OF THE 8080 REGISTERS
;AS SAVED IN MEMORY
;MAY BE USED WITH JUMBO COMMAND TO
;SET A REGISTER PAIR, OR WITH OTHER
;COMMANDS TO SET INDIVIDUAL REGISTERS
;S<P/H/D/B/A>
;
027C CDA103   SETR:  CALL   LCFLD  ;GET REGISTER DESIGNATION
027F 218F02   LXI    H,RTAB ;AND LOOK UP POSITION
  
```

```

0282 CDD801      CALL    LOOKUP
0285 D8          RC          ;RETURN IF NOT VALID REGISTER
0286 210200     LXI      H,2
0289 54          MOV      D,H      ;SET D-0
028A 39          DAD      SP      ;ADD 2 TO STACK POINTER (FOR CAL
028B 19          DAD      D        ;ADD REG. POSITION
028C C33A02     JMP      SVW      ;PUT IN WINDOW

```

```

;
;RTAB IS A TABLE OF THE 8080 REGISTERS
;AND THEIR RELATIVE POSITIONS AS
;STORED ON THE STACK
;

```

```

028F 50      RTAB:  DB      'P'
0290 00      DB      0
0291 48      DB      'H'
0292 04      DB      4
0293 44      DB      'D'
0294 06      DB      6
0295 42      DB      'B'
0296 08      DB      8
0297 41      DB      'A'
0298 0A      DB      10
0299 FF      DB      -1

```

```

;
;GET IS USED BY THE LOADER TO GET
;C BYTES AND STORE THEM AT HL TO HL+C-1
;

```

```

029A AF      GET:   XRA      A
029B 47      MOV      B,A
029C CDA502  GET1:  CALL    TI
029F 77      MOV      M,A      ;PUT BYTE IN MEMORY
02A0 23      INX      H        ;INCREMENT POINTER
02A1 0D      DCR      C
02A2 C29C02  JNZ      GET1

```

```

;
;TI GETS A CHARACTER FROM WH2
;AND KEEPS A CHECKSUM IN B
;D IS USED AS A TEMPORARY
;

```

```

02A5 CD280C  TI:    CALL    WH2
02A8 57      MOV      D,A
02A9 80      ADD      B
02AA 47      MOV      B,A
02AB 7A      MOV      A,D
02AC C9      RET

```

```

;
;SETUP PUTS IMMEDIATE BYTES INTO BAUD RATE GEN.,
;AND THEN USART CTL PORT. THE TERM CHAR IS 00H,
;WHICH IS ALSO XMTED TO USART, LEAVING IT IDLING.
;WHEN DONE, JUMPS TO LOC. AFTER
;IMMED BYTES.
;

```

```

02AD E1      SETUP: POP      H          ;GET ADDR FOLLOWING CALL TO SETU
02AE 7E      MOV      A,M        ;GET DATA FOR BRG

```

```

02AF D304          OUT      4          ;PUT IN BRG
02B1 23          SET1:  INX      H          ;NEXT BYTE
02B2 7E          MOV      A,M
02B3 D301          OUT      1          ; USART PORT
02B5 B7          ORA      A          ;WAS THAT 00H?
02B6 C2B102       JNZ      SET1        ;NO,NEXT BYTE
02B9 E9          PCHL                     ;JUMP TO THE 00H, EXEC. IT AS A
                                           ;CONTINUE

```

```

;
;POLY AND BITE CONTAIN SETUP
;INFORMATION FOR POLYPHASE OR BYTE
;OPERATION OF THE USART
;

```

```

02BA CDAD02       POLY:  CALL     SETUP    ;THE NEXT BYTES GOTO BRG AND USA
02BD 05          DB      005H        ;TO BRG: SELECT DEV 0, 2400 BAUD
02BE AA          DB      0AAH        ;FAKE SYNCH CHAR IF USART EXPECT
02BF 40          DB      040H        ;INTERN. RESET. GETS USART TO MO
02C0 0C          DB      00CH        ;MODE CODE FOR SYNCHRONOUS, 8 BI

```

```

;NO PARITY, INTERN. SYNC, 2 SYNC
02C1 E6          DB      0E6H        ;FIRST SYNC CHAR. TO SRCH FOR
02C2 E6          DB      0E6H        ;2ND SYNC CHAR.
02C3 00          DB      000H        ;LEAVE COMMAND AT 00H (IDLE), RT

```

```

02C4 C3CF02       JMP      NAMER
02C7 CDAD02       BITE:  CALL     SETUP
02CA 06          DB      006H        ;TO BRG: SEL. DEV. 0, 300 BAUD
02CB AA          DB      0AAH        ;FAKE SYNCH CHAR IF USART EXPECT
02CC 40          DB      040H        ;INT. RST. GETS US TO MODE LEVEL
02CD CE          DB      0CEH        ;MODE: ASYNCH., 8 BITS, NO PARIT

```

```

;2 STOP BITS, 16X CLOCK SCALING
02CE 00          DB      000H        ;FOR NOW COMMAND IS IDLE
02CF 21540C       NAMER: LXI     H,FNAME
02D2 79          MOV      A,C          ;ECHO THE B OR P
02D3 CD240C       CALL     WH1
02D6 CD8D03       CALL     CROUT        ;OUTPUT CR
02D9 0E09        MVI     C,9

```

```

;
;NAM0 GETS THE NAME OF THE FILE
;TO BE LOADED FROM THE CONSOLE
;

```

```

02DB CD200C       NAM0:  CALL     WH0
02DE CD240C       CALL     WH1          ;ECHO CHAR.
02E1 FE0D        CPI     13
02E3 CAEC02       JZ      NAM          ;DONE IF CR
02E6 77          MOV      M,A          ;STORE IN MEMORY
02E7 23          INX     H
02E8 0D          DCR     C
02E9 C2DB02       JNZ     NAM0         ;DONE IF 9 CHARACTERS
02EC 3620        NAM:  MVI     M,20H    ;FILL OUT WITH BLANKS
02EE 23          INX     H
02EF 0D          DCR     C
02F0 F2EC02       JP      NAM

```

```

;
;HEAD SEARCHES FOR A RECORD HEADER
;AND STORES IT AT RNAME

```

```

;COMP THEN COMPARES THE NAME AGAINST
;THE NAME IT IS SEARCHING FOR
;GETS NEXT HEADER IF NOT MATCH
;AFTER DISPLAYING NAME AND RECORD NUMBER
;IF CHECKSUM ERROR GOES TO ERROR
;

```

```

02F3 214203 HEAD: LXI H,DNAME
02F6 E5 PUSH H ;ANYTHING RETURNING AFTER HERE
;WILL DISPLAY THE RECD NAME AND
02F7 3E96 HEAD6: MVI A,096H ;START USART READING, ENTER SEAR
;IF SYNCHRONOUS, AND START MOTOR
;TO USART CTL PORT
02F9 D301 OUT 1
02FB CD280C CALL WH2
02FE FEE6 HEAD7: CPI 0E6H ;SYNC CHAR.
0300 C2F702 JNZ HEAD6 ;RESYNC USART
0303 CD280C CALL WH2
0306 FE01 CPI 001H ;SOH CHAR.
0308 C2FE02 JNZ HEAD7
030B 215C0C LXI H,RNAME
030E 0E0E MVI C,14
0310 CD9A02 CALL GET ;GET HEADER
0313 C27003 JNZ ERROR
0316 215C0C LXI H,RNAME ;COMPARE NAMES
0319 11540C LXI D,FNAME
031C 0E08 MVI C,8
031E 1A COMP: LDAX D
031F BE CMP M
0320 C0 RNZ ;NOT MATCH
0321 13 INX D
0322 23 INX H
0323 0D DCR C
0324 C21E03 JNZ COMP ;FALL THRU IF MATCH
0327 2A670C LHLD RADR ;GET LOAD ADDRESS AND
032A 3A660C LDA RLEN ;LENGTH IN PREPARATION FOR LOADI
032D 4F MOV C,A
032E 3A690C LDA RTYPE ;CHECK RECORD TYPE
0331 B7 ORA A
0332 CA6C03 JZ GETD ;DATA, LOAD INTO RAM
0335 3D DCR A
0336 CA5F03 JZ COMNT ;COMMENT, DISPLAY IT
0339 3D DCR A
033A CA7503 JZ STOP ;END OF FILE, STOP TAPE
033D 3D DCR A
033E C0 RNZ ;NOT TYPES 0-3, TRY AGAIN
033F D301 OUT 1 ;STOP TAPE
0341 E9 PCHL ;AUTO-EXECUTE, GO TO PGM.
;

```

```

;WERE DONE LOOKING AT OR READING A RECD, SO DISPLAY
;NAME AND RECD# OF LAST SEEN RECD.
;

```

```

0342 015C0C DNAME: LXI B,RNAME
0345 1608 MVI D,8
0347 37 DNAM2: STC
0348 CD7C01 CALL FLDSY

```

```

034B 15          DCR      D
034C C24703     JNZ      DNAM2
034F CD9703     CALL     BLK
0352 2A640C     LHL D   RRRN      ;DISPLAY R/N
0355 EB         XCHG
0356 CDD103     CALL     DEOUT
0359 CD8D03     CALL     CROUT
035C C3F302     JMP      HEAD

;
;COMNT DISPLAYS COMMENTS ON THE SCREEN
;
035F CD280C     COMNT:   CALL     WH2      ;ECHO TAPE ON CRT FOR A COMMENT
0362 CD7F00     CALL     DSPLY
0365 0D         DCR      C
0366 C25F03     JNZ      COMNT
0369 C3F702     JMP      HEAD6

;
;GETD GETS DATA AND RETURNS IF CS2 IS GOOD
;OTHERWISE IT STOPS THE TAPE
;AND PRINTS A "?"
;
036C CD9A02     GETD:   CALL     GET
036F C8         RZ
0370 3E3F     ERROR:  MVI      A,'?'
0372 CD7F00     CALL     DSPLY
0375 CD8D03     STOP:   CALL     CROUT
0378 AF         XRA      A
0379 D301     OUT     1      ;OUTPUT NUL TO STOP USART
037B E1         POP     H      ;CLEAN UP STACK
037C C31702     JMP     START

;
;***** UTILITY SUBROUTINES *****
;
;THESE SUBROUTINES MAY BE USED EXTERNALLY, SO WE WANT
;THEM IN KNOWN LOCATIONS.
;
;HEX08 OUTPUTS 8 BYTES FROM THE ADDRESS POINTED
;TO BY D,E LEAVING D,E POINTING TO THE NEXT
;LOCATION IN MEMORY. IT PUTS THE BYTES OUT
;IN HEX WITH A SPACE BETWEEN THEM AND A
;CARRAGE RETURN AT THE END OF THE LINE.
;
;D2 IS THE ACTUAL LOOP WHICH HEX08 USES
;IT PUTS OUT THE NUMBER OF BYTES IN B
;INCRMENTS D AND THEN PUTS OUT A
;CARRAGE RETURN.
;
037F 0608     HEX08:  MVI      B,8
0381 CD9703     D2:    CALL     BLK
0384 1A         LDAX   D
0385 CDD603     CALL     BYTE
0388 13         INX    D
0389 05         DCR    B
038A C28103     JNZ    D2

```

```

;
;CROUT, CLEAR, BLK, AND TABBER
;OUTPUT A CARRIAGE RETURN, FORM FEED, BLANK,
;OR HORIZONTAL TAB TO THE CRT DRIVER, RESPECTIVELY
;

```

```

038D 3E0D CROUT: MVI A,CR ;PUT CAR RETRN ON CONSLE DSPLY
038F C37F00 JMP DSPLY
0392 3E0C CLEAR: MVI A,12 ;CTL-L (FORM FEED)
0394 C37F00 JMP DSPLY
0397 3E20 BLK: MVI A,' ' ;SPACE
0399 C37F00 JMP DSPLY
039C 3E09 TABBER: MVI A,9 ;CTL-I TAB
039E C37F00 JMP DSPLY

```

```

;
;LCFLD (LOWER CASE FOLD). GETS A CHAR FROM WH0.
;IF AN LC CHAR WAS FOLDED, CY=0,ELSE CY=1.
;WATCH RUBOUTS! THEY'RE FOLDED TO 5FH FROM NORMAL 7FH.
;

```

```

03A1 CD200C LCFLD: CALL WH0 ;GET CHAR
03A4 FE60 CPI 060H ;IF UPPER CASE,FORGET IT
03A6 D8 RC ;UC LETTERS ARE LESS THAN 60H
03A7 D620 SUI 020H ;FOLD THIS LOWER CASE LETTER ON
03A9 C9 RET

```

```

;
;HEXC INPUTS VARIABLE LENGTH HEX FROM WH0, ECHOING ON DS
;TERM CHAR IS ANY NON-HEX CHAR, AND IT IS RETURNED IN B.
;DIGIT COUNT RETURNED IN C.
;

```

```

03AA 210000 HEXC: LXI H,0 ;ZERO CONVERSION BUFFER
03AD 4D MOV C,L
03AE CDA103 NXNYB: CALL LCFLD ;GET A CASE-FOLDED CHAR FROM WH0
03B1 47 MOV B,A ;SAVE THIS CHAR SO IT CAN BE USE
;IT WAS THE TERM CHAR.
03B2 FE30 CPI '0' ;RETURN IF LESS THAN ASCII 0
03B4 D8 RC
03B5 CD240C CALL WH1 ;ECHO EACH CHAR. VALID OR NOT
03B8 D630 SUI '0' ;CHANGE ASCII INTO BINARY 0-15
03BA FE0A CPI 10
03BC DAC703 JC NXNB1
03BF D607 SUI 7
03C1 FE0A CPI 10
03C3 D8 RC ;RETURN IF NOT HEX
03C4 FE10 CPI 16
03C6 D0 RNC ;RETURN IF NOT HEX
03C7 0C NXNB1: INR C ;COUNT # OF HEX CHARACTERS
03C8 29 DAD H ;SHIFT HL
03C9 29 DAD H ;OVER
03CA 29 DAD H ;FOR NEXT
03CB 29 DAD H ;DIGIT
03CC B5 ORA L ;OR IN NEW DIGIT
03CD 6F MOV L,A
03CE C3AE03 JMP NXNYB

```

```

;
;DEOUT OUTPUTS DE TO THE SCREEN

```

```

;AS 4 HEX DIGITS
;
03D1 7A      DEOUT:  MOV      A,D
03D2 CDD603      CALL    BYTE
03D5 7B      MOV      A,E
;
;BYTE OUTPUTS THE ACCUMULATOR
;AS 2 HEX DIGITS TO THE SCREEN
;
03D6 F5      BYTE:   PUSH    PSW
03D7 0F      RRC
03D8 0F      RRC
03D9 0F      RRC
03DA 0F      RRC
03DB CDDF03      CALL    HEXO
03DE F1      POP     PSW
;
;HEXO OUTPUTS 1 HEX DIGIT TO
;THE SCREEN - THE UPPER HALF
;OF A IS MASKED WITH ZEROS
;
03DF E60F      HEXO:   ANI     15
03E1 C690      ADI     90H
03E3 27      DAA
03E4 CE40      ACI     40H
03E6 27      DAA
03E7 C37F00      JMP     DSPLY ;OUTPUT HEX DIGIT AND USE RETURN
;
;***** INITIALIZATION PARAMETERS *****
;THE FOLLOWING INFORMATIO IS USED ON FPRST OR POC
;TO SETUP THE STARTING SYSTEM CONTEXT.
;
1000      STACK  EQU     01000H ; USED IN AN LXI,SP
;
;THE FOLLOWING BLOCK IS COPIED DIRECTLY OVER
;SYSTEM RAM STARTING AT SRA4.
;
03EA 5400      INITER:  DW     USRTSR ;VI3 USART INTERUPT
03EC 0D01      DW     KSR   ;VI2: THE STANDARD KBD INT
03EE 6400      DW     IORET  ;WAKEUP: NOTHING FOR NOW
03F0 1701      DW     SAVE  ;VI0: SINGLE STEP INT GOES BACK
03F2 FC      DB     0FCH  ;VIDEO SCRN ENDS AT FC00H-1
03F3 F8      DB     0F8H  ;VIDEO SCRN HOME AT F800H
03F4 CD6A00      CALL    KI    ;WORMHOLE 0: INIT TO KBD AT F8H
03F7 C9      RET     ;STANDARD PART OF ANY WORMHOLE
03F8 CD7F00      CALL    DSPLY ;WORMHOLE 1: INIT TO VIDEO DSPL
03FB C9      RET
03FC CD7800      CALL    USRTI ;WORMHOLE 2: INIT TO USART AT 0
03FF C9      RET
0000      END

```

SYMBOLS SORTED BY NAME

| | | | | | | | | | |
|-------|------|-------|------|-------|------|-------|------|-------|------|
| ADDIT | 023E | BITE | 02C7 | BLK | 0397 | BYTE | 03D6 | CLEAR | 0392 |
| CLINE | 00D0 | CLOCK | 0030 | COMD | 01BA | COMNT | 035F | COMP | 031E |
| CR | 000D | CROUT | 038D | CRR | 00E6 | CTLX | 0018 | CTLZ | 001A |
| CURP | 00DC | D2 | 0381 | DEOUT | 03D1 | DISP | 0134 | DISP1 | 0148 |
| DNAM2 | 0347 | DNAME | 0342 | DOUBL | 022C | DSPLY | 007F | ERROR | 0370 |
| FF | 000C | FF1 | 00F2 | FFR | 00EF | FLAGS | 0187 | FLDSY | 017C |
| FNAME | 0C54 | G | 026C | GET | 029A | GET1 | 029C | GETD | 036C |
| HEAD | 02F3 | HEAD6 | 02F7 | HEAD7 | 02FE | HEXC | 03AA | HEXO | 03DF |
| HEX08 | 037F | IND | 0249 | INITE | 03EA | INITL | FFEA | IOPUT | 0060 |
| IORET | 0064 | KBUFF | 0C0C | KI | 006A | KI1 | 006E | KSR | 010D |
| LCFLD | 03A1 | LOD | 0237 | LOOKU | 01DB | MMOD | 0198 | MMOD1 | 01A8 |
| MOVE | 0100 | MSG | 016D | MTBL | 01E8 | NAM | 02EC | NAM0 | 02DB |
| NAMER | 02CF | NORM | 00B4 | NXNB1 | 03C7 | NXNYB | 03AE | PCLY | 02BA |
| POS | 0C0E | POS2 | 0C4A | POS3 | 0C4E | RADR | 0C67 | RB | 007F |
| RBR | 00E4 | RBUFF | 0C0A | RESET | 0000 | RLEN | 0C66 | RNAME | 0C5C |
| RRN | 0C64 | RST1 | 0200 | RTAB | 028F | RTN | 0200 | RTYPE | 0C69 |
| SAVE | 0117 | SAVPC | 0C52 | SCEND | 0C1E | SCND2 | 0C48 | SCND3 | 0C4C |
| SCRH2 | 0C49 | SCRH3 | 0C4D | SCRHM | 0C1F | SCRL | 00B9 | SET1 | 02B1 |
| SETR | 027C | SETUP | 02AD | SRA1 | 0C10 | SRA2 | 0C12 | SRA3 | 0C14 |
| SRA4 | 0C16 | SRA5 | 0C18 | SRA7 | 0C1C | SS | 0038 | STACK | 1000 |
| START | 0217 | STOP | 0375 | STORE | 0253 | SVW | 023A | TAB | 0009 |
| TABBE | 039C | TANI | 0C04 | TAPE | 0214 | TBUFF | 0C08 | TI | 02A5 |
| TIME | 0040 | TIME2 | 0047 | TIMER | 0C00 | USRTI | 0078 | USRTS | 0054 |
| VCB2 | 0C48 | VCB3 | 0C4C | VI2 | 0028 | VI3 | 0020 | VI4 | 0018 |
| VI5 | 0010 | VI6 | 0008 | VT | 000B | VTR | 00F9 | WAKEU | 0C1A |
| WARM | 0121 | WH0 | 0C20 | WH1 | 0C24 | WH2 | 0C28 | WH3 | 0C2C |
| WH4 | 0C30 | WH5 | 0C34 | WH6 | 0C38 | WH7 | 0C3C | WH8 | 0C40 |
| WH9 | 0C44 | WINDO | 0C50 | WIPE | 00D5 | X | 0259 | | |

SYMBOLS SORTED BY VALUE

| | | | | | | | | | |
|-------|------|-------|------|-------|------|-------|------|-------|------|
| RESET | 0000 | VI6 | 0008 | TAB | 0009 | VT | 000B | FF | 000C |
| CR | 000D | VI5 | 0010 | CTLX | 0018 | VI4 | 0018 | CTLZ | 001A |
| VI3 | 0020 | VI2 | 0028 | CLOCK | 0030 | SS | 0038 | TIME | 0040 |
| TIME2 | 0047 | USRTS | 0054 | IOPUT | 0060 | IORET | 0064 | KI | 006A |
| KI1 | 006E | USRTI | 0078 | DSPLY | 007F | RB | 007F | NORM | 00B4 |
| SCRL | 00B9 | CLINE | 00D0 | WIPE | 00D5 | CURP | 00DC | RBR | 00E4 |
| CRR | 00E6 | FFR | 00EF | FF1 | 00F2 | VTR | 00F9 | MOVE | 0100 |
| KSR | 010D | SAVE | 0117 | WARM | 0121 | DISP | 0134 | DISP1 | 0148 |
| MSG | 016D | FLDSY | 017C | FLAGS | 0187 | MMOD | 0198 | MMOD1 | 01A8 |
| COMD | 01BA | LOOKU | 01DB | MTBL | 01E8 | RST1 | 0200 | RTN | 0200 |
| TAPE | 0214 | START | 0217 | DOUBL | 022C | LOD | 0237 | SVW | 023A |
| ADDIT | 023E | IND | 0249 | STORE | 0253 | X | 0259 | G | 026C |
| SETR | 027C | RTAB | 028F | GET | 029A | GET1 | 029C | TI | 02A5 |
| SETUP | 02AD | SET1 | 02B1 | POLY | 02BA | BITE | 02C7 | NAMER | 02CF |
| NAM0 | 02DB | NAM | 02EC | HEAD | 02F3 | HEAD6 | 02F7 | HEAD7 | 02FE |

| | | | | | | | | | |
|-------|------|-------|------|-------|------|-------|------|-------|------|
| COMP | 031E | DNAME | 0342 | DNAM2 | 0347 | COMNT | 035F | GETD | 036C |
| ERROR | 0370 | STOP | 0375 | HEX08 | 037F | D2 | 0381 | CROUT | 038D |
| CLEAR | 0392 | BLK | 0397 | TABBE | 039C | LCFLD | 03A1 | HEXC | 03AA |
| NXNYB | 03AE | NXNB1 | 03C7 | DEOUT | 03D1 | BYTE | 03D6 | HEX0 | 03DF |
| INITE | 03EA | TIMER | 0C00 | TANI | 0C04 | TBUFF | 0C08 | RBUFF | 0C0A |
| KBUFF | 0C0C | POS | 0C0E | SRA1 | 0C10 | SRA2 | 0C12 | SRA3 | 0C14 |
| SRA4 | 0C16 | SRA5 | 0C18 | WAKEU | 0C1A | SRA7 | 0C1C | SCEND | 0C1E |
| SCRHM | 0C1F | WH0 | 0C20 | WH1 | 0C24 | WH2 | 0C28 | WH3 | 0C2C |
| WH4 | 0C30 | WH5 | 0C34 | WH6 | 0C38 | WH7 | 0C3C | WH8 | 0C40 |
| WH9 | 0C44 | SCND2 | 0C48 | VCB2 | 0C48 | SCRH2 | 0C49 | POS2 | 0C4A |
| SCND3 | 0C4C | VCB3 | 0C4C | SCRH3 | 0C4D | POS3 | 0C4E | WINDO | 0C50 |
| SAVPC | 0C52 | FNAME | 0C54 | RNAME | 0C5C | RRN | 0C64 | RLEN | 0C66 |
| RADR | 0C67 | RTYPE | 0C69 | STACK | 1000 | INITL | FFEA | | |

THATS ALL, FOLKS!



***** SMALL DUMPER FOR 4.0 ONBOARD RAM *****

SMD IS A SIMPLE ABSOLUTE DUMPER WHICH RUNS ENTIRELY WITHIN THE ONBOARD MONITOR RAM FROM C6AH TO D9CH. ITS STARTING ADDRESS IS C6A HEX. WHEN RUN, IT CLEARS THE SCREEN AND EXPECTS AN ENCODING SPECIFICATION AND FILENAME JUST AS THE 4.0 RESIDENT LOADER. AFTER THESE ARE INPUT, THE STARTING AND ENDING HEX ADDRESSES ARE INPUT AS SHOWN IN THE FOLLOWING EXAMPLE WHERE THE SMD IS USED TO COPY ITSELF:

(SCREEN CLEARED, CURSOR IN UPPER LEFT)

B
SMD

C6A,D9D (D9D USED FOR SAFETY)
C6A
D6A
D6A (THIS LAST IS AN ENDRECORD)

(SCREEN CLEARS AGAIN, READY FOR ANOTHER DUMP)

BEFORE DATA IS DUMPED, THE CASSETTE RECORDER SHOULD BE SETUP WITH THE PROPER PLUG IN THE MICROPHONE JACK. THE BYTE/BIPHASE CASSETTE CARD HAS TWO PLUGS FOR WRITING - ONE FOR BYTE AND ONE FOR BIPHASE. THE READ PLUG (LABELLED USUALLY "EAR" OR "SPKR") SHOULD NOT BE PLUGGED IN. SOME CASSETTES DO ODD THINGS WHEN BOTH THE MIC AND EXTERNAL SPKR JACKS ARE PLUGGED IN. ALSO MAKE SURE THAT ENOUGH TAPE RUNS BEFORE TYPING THE FINAL CARRIAGE RETURN ON THE END ADDRESS SPECIFICATION SO THAT NON-RECORDABLE LEADER GETS A CHANCE TO PASS BY BEFORE DUMPING STARTS.

THE ONBOARD DUMPER WAS HAND OPTIMIZED TO FIT INSIDE THE FREE SPACE ON SYSTEM RAM, BUT THE SYSTEM STACK ALSO RESIDES THERE. THIS MEANS THAT THE STACK MAY OVERRUN THE DUMPER, ERASING PART OF IT. IF THE DUMPER HAS BEEN IN RAM WHILE BASIC HAS BEEN RUN, FOR EXAMPLE, THE STACK HAS PROBABLY SQUASHED IT AT SOME TIME. IF THERE IS DOUBT, CHECK THE BYTE AT D99H. IT SHOULD BE A C9 (RETURN INSTRUCTION). IF IT IS NOT, OR YOU JUST WANT TO MAKE SURE, RELOAD THE DUMPER JUST BEFORE USING IT.

WHEN THE DUMPER IS DUMPING, EACH RECORD WILL BE DISPLAYED AS A HEX NUMBER ON THE SCREEN. THE HEX NUMBER REPRESENTS

THE ADDRESS OF THE DATA BEING DUMPED ON EACH RECORD.
THAT ADDRESS IS PUT ON THE HEADER OF THE RECORD SO
THE 4.0 RESIDENT LOADER WILL KNOW WHERE TO PUT IT
WHEN IT IS READ BACK IN.

THE LAST RECORD IS AN "END" TYPE RECORD.
IT IS PUT ON AUTOMATICALLY. IT WILL DISPLAY AS A RECORD
WITH DUMP ADDRESS EQUAL TO THE ADDRESS OF THE RECORD
BEFORE IT. OPTIMIZATION OF THE DUMPER'S CODE REQUIRES
SOME STRANGENESSES SUCH AS THIS, BUT IN ANY CASE, THE
LAST RECORD (DUMP FINISHED) WILL BE SIGNALLED BY THE
SCREEN CLEARING. THIS PUTS THE DUMPER BACK IN ITS
INITIAL MODE, JUST AS IF IT HAD BEEN RESTARTED AT C6AH.
MORE DATA MAY BE DUMPED IF DESIRED.

; ***** ONBOARD DUMPER FOR 4.0 *****

```
;
;      THIS IS A POLYFORMAT DUMPER FOR ABSOLUTE
;DATA WHICH RUNS FROM C6A TO D9F (OR SO), START ADDRESS
;C6AH.  WHEN RUN, IT ACTS LIKE 4.0 MONITOR TAPE LOAD IN
;THE WAY IT ACCEPTS ENCODING SPECIFICATION (B OR P) AND
;FILE NAME.  THEN IT EXPECTS TWO HEX NUMBERS FOR
;START AND END DUMP ADDRESSES.  EACH RECORD DUMPED SHOWS
;ADDRESS USED IN HEX ON SCREEN.  WHEN DONE, IT PUTS OUT
;AN "END" TYPE RECORD AND CLEARS SCREEN, READY.
;FOR ANOTHER DUMP.
;
;ORIGINAL 2.2 DUMPER SYSTEM WRITTEN BY DAVID FAIMAN
;REWRITTEN, DOCUMENTED AND CONVERTED TO ONBOARD FOR 4.0
;BY R.L.DERAN
;
```

```
;
;
0C20      WH0      EQU      0C20H
0C24      WH1      EQU      0C24H
0C16      SRA4     EQU      0C16H
02AD      SETUP   EQU      02ADH
03AA      HEXC     EQU      03AAH
03D1      DEOUT   EQU      03D1H
0C5A      EQU      0C5CH-2
0C5A      LENGTH: DS      2
0C5C      WNAME:  DS      8
0C64      WRN:    DS      2
0C66      WLEN:   DS      1
0C67      WADR:   DS      2
0C69      WTYPE:  DS      1
0C6A      21450D  START:  LXI      H,TISR
0C6D      22160C          SHLD     SRA4
0C70      3E0C      STAR2:  MVI      A,0CH      ;FORM FEED
0C72      CD240C          CALL     WH1        ;CLEAR SCREEN
0C75      CD200C          CALL     WH0
0C78      CD240C          CALL     WH1
0C7B      FE42          CPI      'B'
0C7D      CA920C          JZ       BITE
0C80      FE50          CPI      'P'
0C82      C2700C          JNZ     STAR2
0C85      CDAD02  POLY:   CALL     SETUP
0C88      05          DB      005H
0C89      AA          DB      0AAH
0C8A      40          DB      040H
0C8B      0C          DB      00CH
0C8C      E6          DB      0E6H
0C8D      E6          DB      0E6H
0C8E      00          DB      000H
0C8F      C39A0C          JMP      NAMER
0C92      CDAD02  BITE:   CALL     SETUP
0C95      06          DB      006H
0C96      AA          DB      0AAH
```

```

0C97 40          DB      040H
0C98 CE          DB      0CEH
0C99 00          DB      000H

;
;      NAMEING ROUTINE
;
0C9A 210000      NAMER:  LXI      H,0
0C9D 22640C      SHLD     WRN
0CA0 0E08        MVI      C,8      ;BLANK NAME FIELD
0CA2 21630C      LXI      H,WNAME+7
0CA5 3620        NAM:     MVI      M,020H
0CA7 2B          DCX      H      ;BACKUP H TO WNAME
0CA8 0D          DCR      C
0CA9 C2A50C      JNZ      NAM
0CAC 23          INX      H
0CAD 0E08        MVI      C,8
0CAF CD180D      CALL     CRLF
0CB2 CD200C      NAM0:    CALL     WH0
0CB5 CD240C      CALL     WH1
0CB8 FE0D        CPI      00DH    ;CR
0CBA CAC30C      JZ       DUMPC
0CBD 77          MOV      M,A
0CBE 23          INX      H
0CBF 0D          DCR      C
0CC0 C2B20C      JNZ      NAM0
0CC3 AF          DUMPC:   XRA      A
0CC4 32690C      STA      WTYPE
0CC7 CD180D      CALL     CRLF
0CCA CDAA03      SIZE:    CALL     HEXC
0CCD 22670C      SHLD     WADR
0CD0 78          MOV      A,B
0CD1 CD240C      CALL     WH1
0CD4 EB          XCHG
0CD5 CDAA03      CALL     HEXC
0CD8 CD180D      CALL     CRLF
0CDB 7D          MOV      A,L
0CDC 93          SUB      E
0CDD 6F          MOV      L,A
0CDE 7C          MOV      A,H
0CDF 9A          SBB     D
0CE0 67          MOV      H,A
0CE1 225A0C      SHLD     LENGTH
0CE4 CDF60C      CALL     DUMPR
0CE7 3E02        ENDC:   MVI      A,2
0CE9 32690C      STA      WTYPE
0CEC 3D          DCR      A
0CED 32660C      STA      WLEN
0CF0 CD540D      CALL     DUMP
0CF3 C36A0C      JMP      START

;
;      DUMP DATA RECORDS
;
0CF6 215B0C      DUMPR:  LXI      H,LENGTH+1
0CF9 7E          MOV      A,M
0CFA B7          ORA      A
0CFB CA100D      JZ       OVER
0CFE 35          DCR      M

```

```

0CFF AF          XRA      A
0D00 32660C      STA      WLEN
0D03 CD540D      CALL     DUMP
0D06 2A670C      LHL D   WADR
0D09 24          INR      H
0D0A 22670C      SHLD   WADR
0D0D C3F60C      JMP     DUMPR
0D10 2B          OVER:   DCX     H
0D11 7E          MOV     A,M
0D12 32660C      STA     WLEN
0D15 C3540D      JMP     DUMP
;
0D18 3E0D      CRLF:  MVI     A,0DH
0D1A CD240C      CALL   WH1
0D1D C9          RET
;
;          ROUTINE TO OUTPUT A RECORD
;
0D1E 0600      PUT:   MVI     B,0      ;CLEAR CHECKSUM
0D20 4F          MOV     C,A      ;PUT LENGTH OF RECORD IN C
0D21 7E          PUT0:  MOV     A,M
0D22 23          INX     H
0D23 F5          PUSH   PSW
0D24 80          ADD     B
0D25 47          MOV     B,A
0D26 F1          POP    PSW
0D27 CD340D      CALL   TO
0D2A 0D          DCR     C
0D2B C2210D      JNZ    PUT0
0D2E 78          MCV     A,B
0D2F 2F          CMA
0D30 3C          INR     A
0D31 C3340D      JMP     TO
;
;          TAPE OUTPUT ROUTINE
;
0C08          TBUFF  EQU     0C08H
0D34 E5          TO:   PUSH   H
0D35 21080C      LXI    H,TBUFF
0D38 F5          PUSH   PSW
0D39 7E          TOL:  MOV     A,M
0D3A B7          ORA    A
0D3B C2390D      JNZ    TOL
0D3E 23          INX     H
0D3F F1          POP    PSW
0D40 77          MOV     M,A
0D41 2B          DCX     H
0D42 34          INR     M
0D43 E1          POP    H
0D44 C9          RET
;
;          TISR IS A SIMPLE USART READER WHICH WILL
;          RE-TRANSMIT THE CHARACTER IN TBUFF IF IT HAS NOT
;          BEEN REPLACED BY THE WORMHOLE ROUTINE. IT
;          DOES NOT CHECK THE FLAG, BECAUSE IT ASSUMES
;          THAT THE PROGRAM CALLING THE WORMHOLE IS FASTER
;          THAN THE USART AND SO IT ALWAYS HAS A VALID

```

; CHARACTER FOR US TO TAKE.

```

;
;
0D45 AF      TISR:   XRA      A
0D46 32080C      STA      TBUFF
0D49 3A090C      LDA      TBUFF+1
0D4C D300      OUT      0
0D4E E1      IORET:  POP      H
0D4F D1      POP      D
0D50 C1      POP      B
0D51 F1      POP      PSW
0D52 FB      EI
0D53 C9      RET

;
;
; DUMP PUTS OUT ONE COMPLETE RECORD.
; IT TURNS ON USART AND MOTORS, WAITS A WHILE
; FOR AN IRG, PUTS OUT 64 SYNCH CHARACTERS,
; DUMPS A RECORD ACCORDING TO THE WRITE CONTROL
; BLOCK AT WNAME (IT ALSO PUTS THE WCB
; ON THE RECORD AS HEADER), INCREMENTS THE RECORD
; NUMBER, STOPS USART AND MOTORS, AND RETURNS.
;
0D54 3E21      DUMP:   MVI      A,021H
0D56 D301      OUT      1
0D58 2A670C      LHLD     WADR
0D5B EB      XCEG
0D5C CDD103      CALL     DEOUT ;DISPLAY THE ADDRESS WE'RE DUMPI
0D5F CD180D      CALL     CRLF
0D62 21FF8F      LXI     H,08FFFH
0D65 2B      DELAY:  DCX     H
0D66 7C      MOV     A,H
0D67 B7      ORA     A
0D68 C2650D      JNZ     DELAY
0D6B 0E40      MVI     C,64
0D6D 3EE6      MVI     A,0E6H ;SYNC CHARACTER
0D6F CD340D      DUMP0:  CALL     TO
0D72 0D      DCR     C
0D73 C26F0D      JNZ     DUMP0
0D76 3E01      MVI     A,001H ;START OF HEADER
0D78 CD340D      CALL     TO

;
;
; DUMP HEADER AND DATA RECORDS
;
;
0D7B 3E0E      MVI     A,00EH ;LENGTH OF HEADER RECORD
0D7D 215C0C      LXI     H,WNAME
0D80 CD1E0D      CALL     PUT
0D83 3A660C      LDA     WLEN
0D86 2A670C      LHLD   WADR
0D89 CD1E0D      CALL     PUT
0D8C 21640C      LXI     H,WRN
0D8F 34      INR     M
0D90 AF      OFF:   XRA     A
0D91 CD340D      CALL     TO ;THESE PUSH OUT LAST BYTES FROM
0D94 CD340D      CALL     TO ;THE USART AND WH BUFFER PIPELIN
0D97 CD340D      CALL     TO ;TURN OFF MOTOR AND TRANSMITTER
0D9A D301      OUT     1
0D9C C9      RET
0000      END

```

For VTI Rev. 1.2; CPU Rev. 0.3; Backplane Rev. 2.1

1. R14 on the CPU board schematic is incorrectly designated 2.2K -- it should be 1K. This resistor goes from pin 4 of IC9 to +5V.
2. Connection hardware has been provided for keyboard input and video output. The recommended connector configuration for the keyboard is as follows:

| Cannon Jack | Dual-in-line-socket |
|-------------|----------------------------|
| 1 | 1 |
| 2 | 2 |
| 3 | 3 |
| 4 | 4 |
| 5 | 5 |
| 6 | 6 |
| 7 | 7 |
| 8 | 8 |
| 9 | 9 |
| 10 - 21 | ground (10) |
| 22 | ground (11) |
| 23 | ground (12) |
| 24 | optional minus supply (13) |
| 25 | +5V supply (14) |

3. For Rev. 1.2 VTI only: On page 20, there are two errors. The color for R17 (2,200 ohms) should be red-red-red. R25 should be a 3,300 ohm resistor with a color code of orange-orange-red.
4. The stripe down the side of the color coded tantalum capacitor indicates the positive lead.
5. For VTI card Rev. 1.2: JMP 3 and JMP 6 should NOT be changed



except in rare cases where vertical retrace must be extended. The display stability will diminish for many monitors if these jumpers are changed.

- 6. For VTI card Rev. 1.2: there is an artwork error on the video board which requires a modification. On the back side of the board, jumper pins 8 and 9 of IC29 together, with #24 wire and insulating tubing. Similarly, jumper pins 15 and 16 of IC29 together.

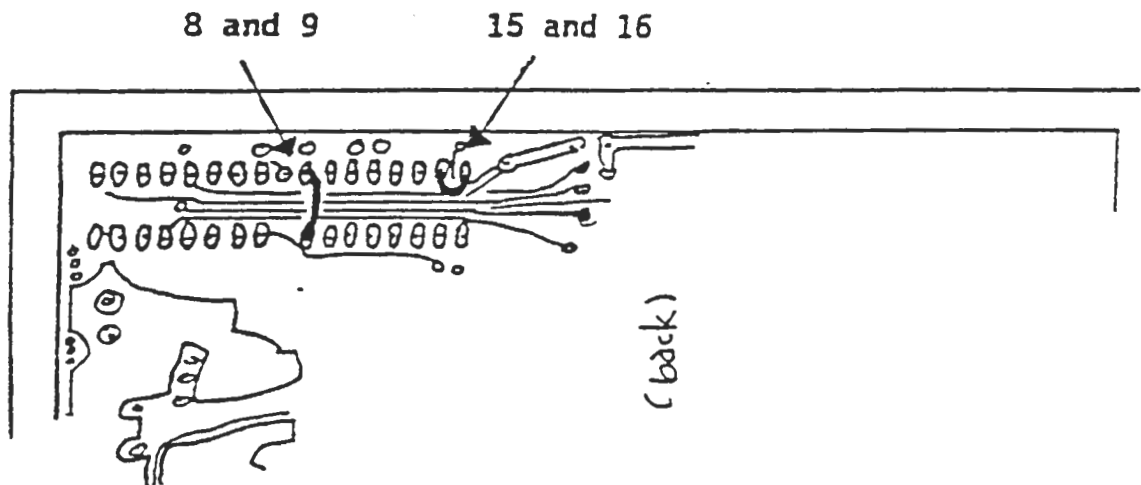

- 7. You should not make this modification in a POLY 88. Hence, JMP 2 is not discussed in the manual. The wiring for this modification depends on the intended use. Most non-POLY 88 applications do not have vectored interrupt. If you ever use the VTI in a system that does use the VTI keyboard port with interrupts, cut the PC jumper and install a jumper as shown below.



DO NOT MAKE THIS MODIFICATION IN A POLY 88!



8. This erratum offers you a choice. You can make a simple modification if you do not wish to use the status port portions of the Video Terminal Interface (i.e. you will always use interrupts for inputting keyboard data). If you will ever use the status port method of keyboard access, a more tedious modification is necessary. (Modification B)

Note: the POLY 88 does not use the status port facilities;
interrupt usage is more efficient.

Make modification A if you do not want to use the status port circuitry. Make modification B if you do wish to use the status port. Make sure the corrections are accurate as major damage can result from carelessness.

Status Port Elimination-Modification A

Ground pin 1 of IC8 by installing an insulated jumper from pin 1 to pin 8 of IC8 as shown on Page E-4. Adjacent to pin 16 of IC19 is a trace which drops through a plated through hole from the front. Cut the trace where it attaches to the feed-through hole on the front of the board. Attach a jumper from pin 1 of IC19 to pin 9 on IC6 as shown on Page E-4.

Status Port Modification-Modification B

PolyMorphic Systems VTI revision 1.2 has been designed for random access memories (RAMs) with an access time of 300ns. PolyMorphic Systems has been unable to obtain parts accomodating 300ns access time. The following changes are recommended to allow reliable use of the 500ns memory chips. All 91L11APC and 21L11-1 memories are rated at 500ns access.

The modification shown in Figure A accomplishes two tasks: 1) The



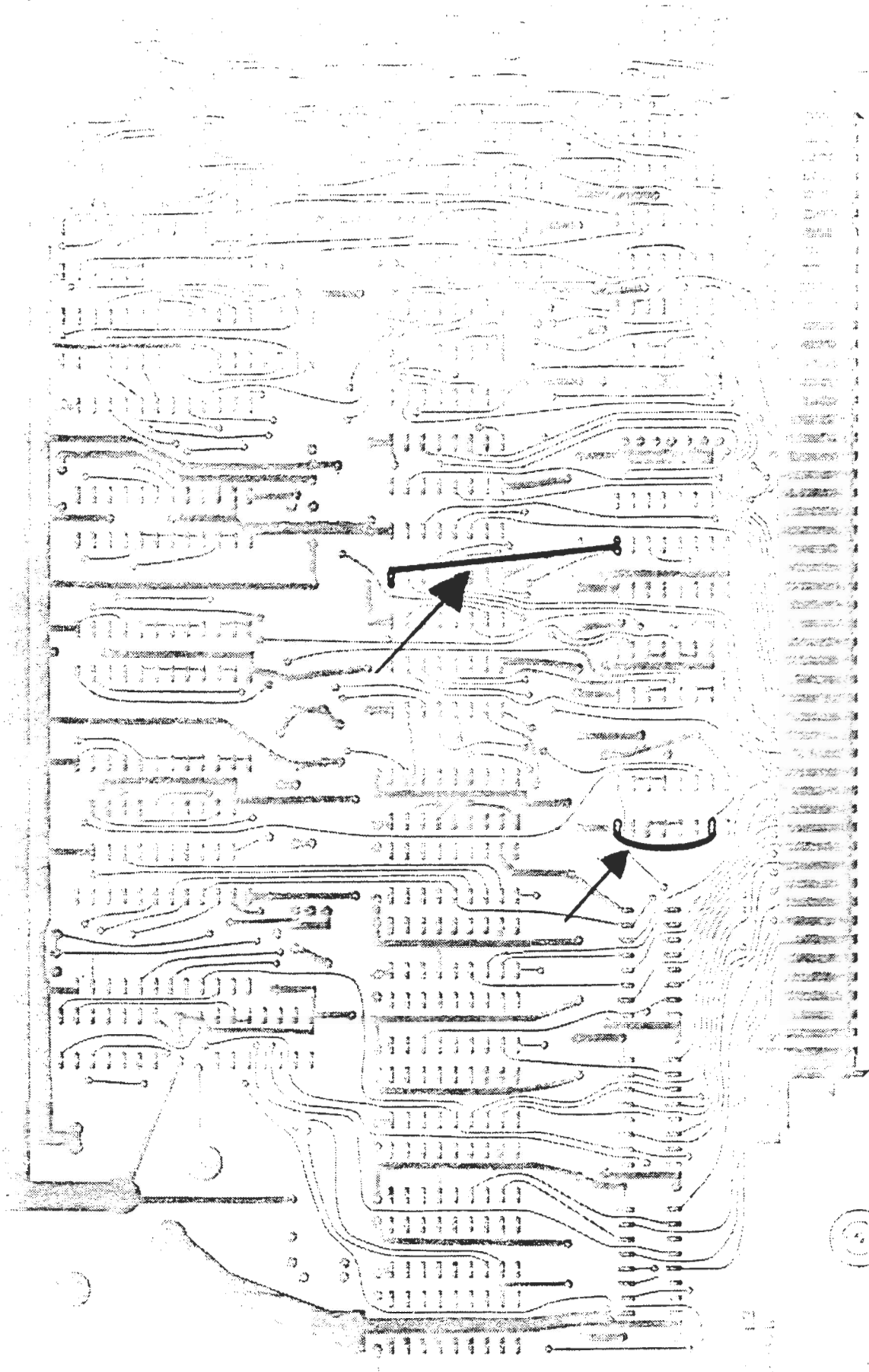

VTI Rev. 1.2 Status Port Elimination

Please Note: One trace must be cut on the front of the card.



OR gate (IC20) is used to gate the SYNC+ signal with A0+ instead of the output from the 8131 address comparator. 2) The inputs to IC8 at pins 1 and 15 are grounded (the Schmitt trigger gate is effectively removed from the circuit).

Three cuts (A, B & C) and four jumpers (J1, J2, J3 & J4) are required for this modification. Refer to Figures A and D. Figure B shows the circuit prior to modification. Figure C shows the circuit after change, along with additional control and output signals for IC8.

Card usage remains the same. Each starting address selection for the memory-mapped display is associated with four input ports. For example: if the user selects F800 hex as a starting address, ports F8, F9, FA and FB are associated with the keyboard.

If your program inputs from an odd port (F9 or FB in the example), the keyboard status is placed in the accumulator as shown below:

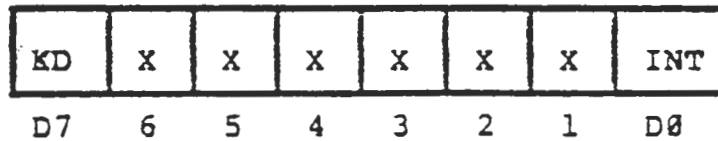

Status Port bit D7 (KD) follows the strobe from the keyboard (or the inverted strobe on many keyboards). PolyMorphic Systems' keyboard produces a zero (0) when a key is depressed and a one (1) when no key is depressed.

Status Port bit D0 (INT) is a zero when a key has been depressed but not inputted to the CPU. This bit is set to a one when the CPU receives the character. Status Port bits K1 through D6 are not used.

If your program inputs from an even port (F8 or FA for address



selection of F800 hex), the data from the keyboard is placed in the accumulator.

Procedure (all work is done on the backside of the board):

- J1) Install insulated jumper between pin 9 of IC6 and pin 13 of IC8.
- J2) Install insulated jumper between pin 4 of IC20 and pin 2 of IC8.
- J3) Install insulated jumper between 11 of IC17 to pin 2 of IC20.
- J4) Install insulated jumper from pin 1 to pin 8 of IC8.
 - A) Cut trace leaving pin 4 of IC20.
 - B) Cut trace leaving pin 9 of IC6.
 - C) Cut trace leaving pin 2 of IC8.

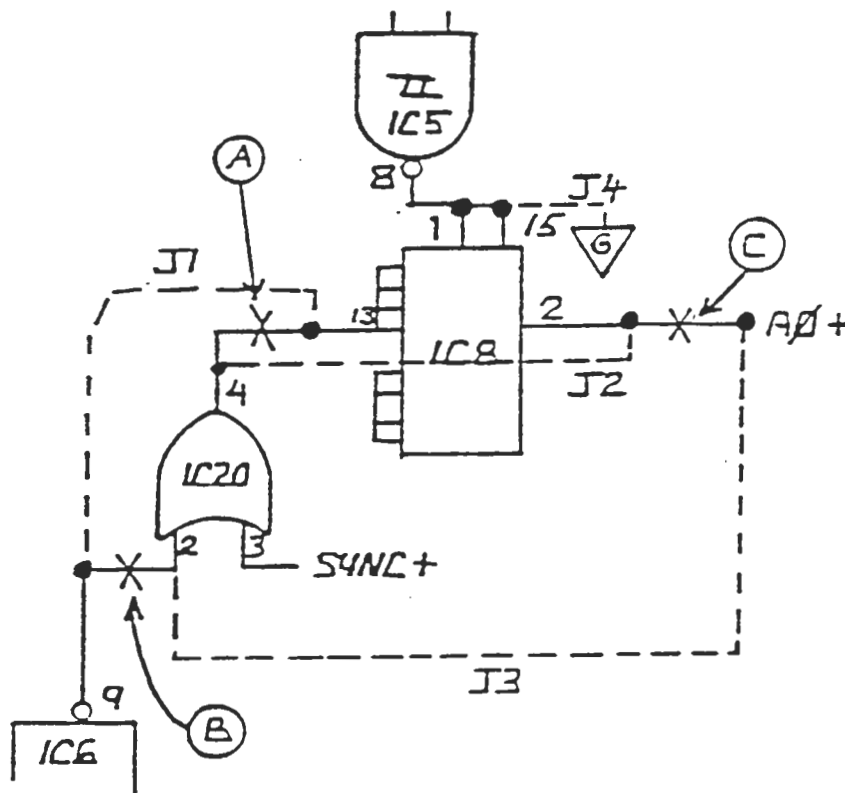
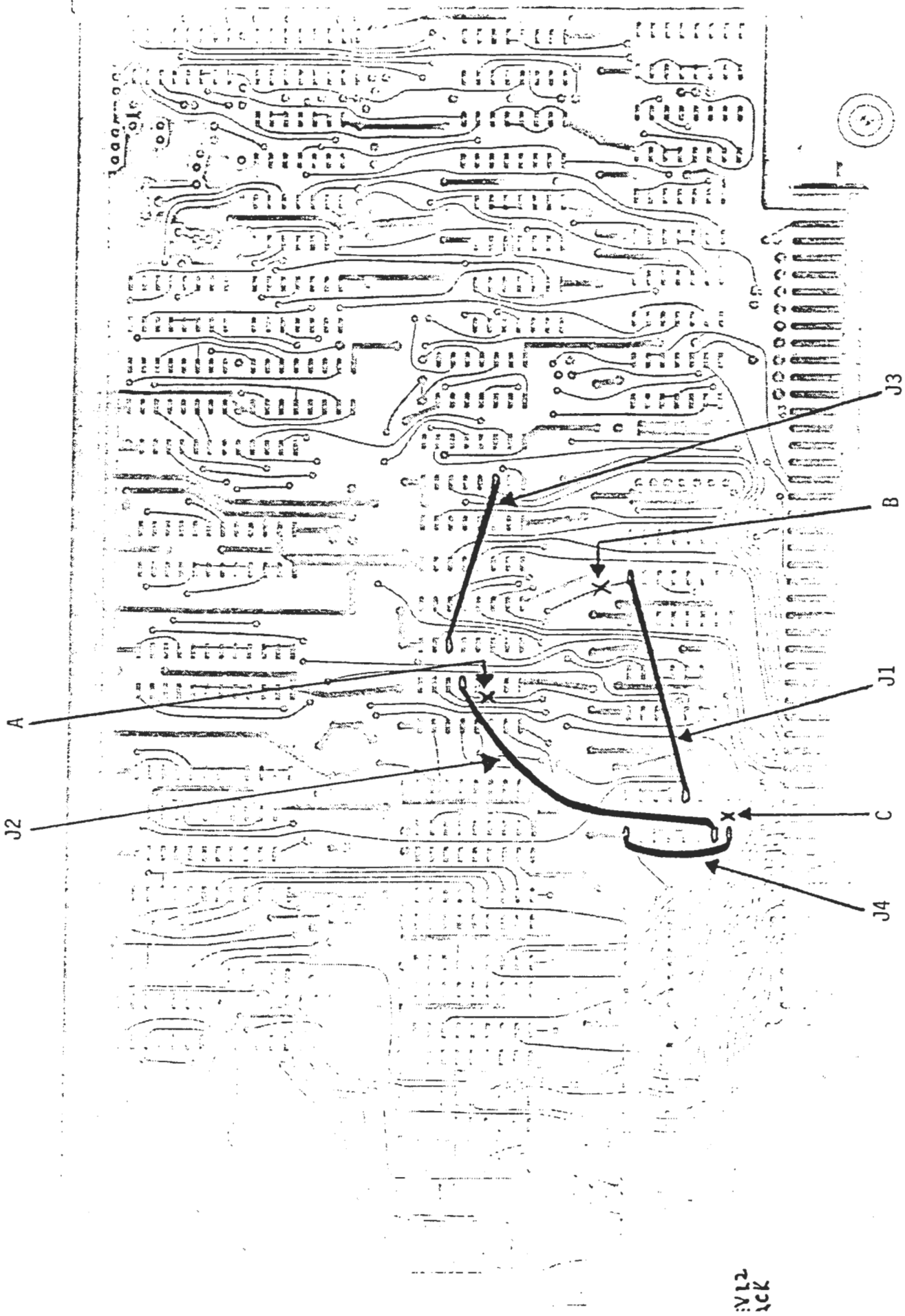

Figure A





V12
ACK



9. The real time clock (RTC) runs too fast on some POLY 88's. To eliminate this problem, install a 0.1 μ F ceramic disc capacitor from pin 9 to pin 7 in IC 20 (74LS123) of the CPU board. Keep the leads short in length to avoid shorting them to other circuitry. Install the capacitor on the rear of the board (DO NOT SOLDER THE CAPACITOR DIRECTLY TO THE INTEGRATED CIRCUIT CHIP).

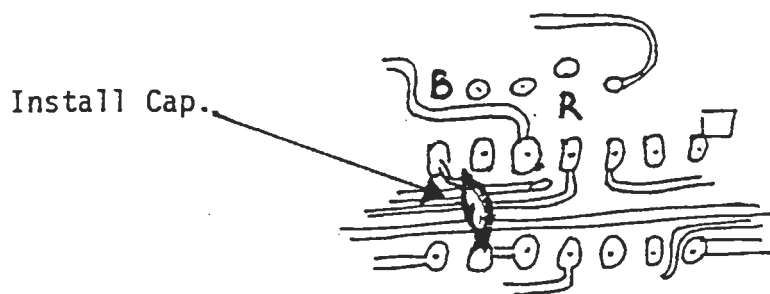



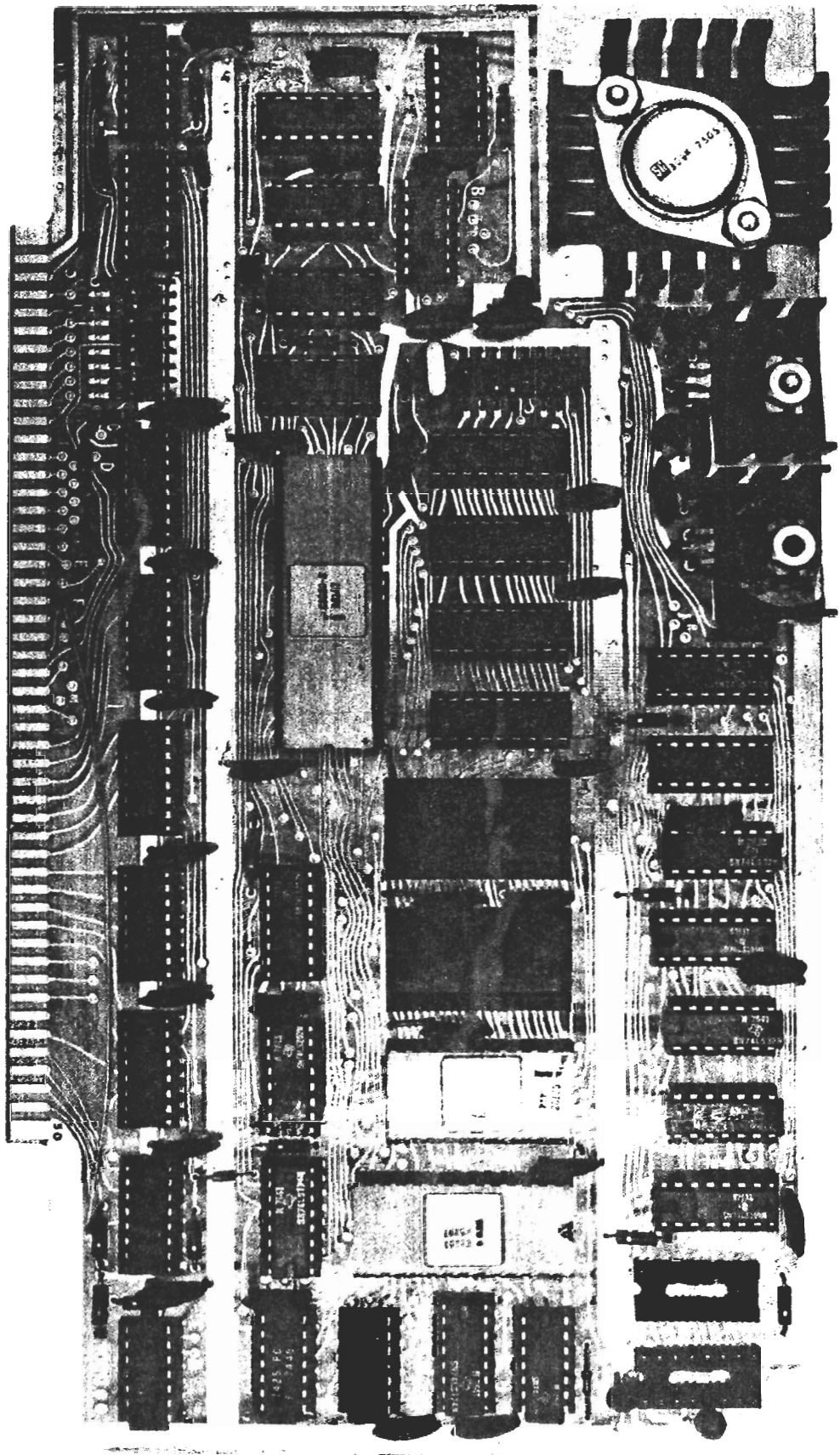

APPENDIX C Chip pinouts

Appendix C Cont'd

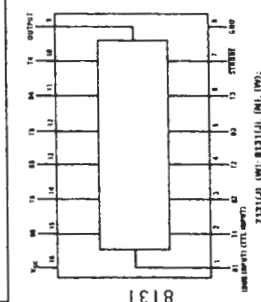
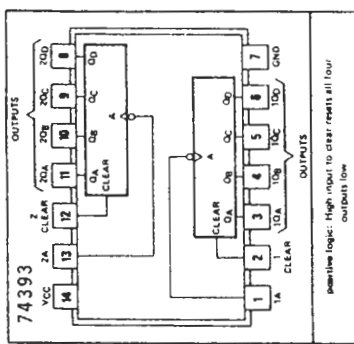
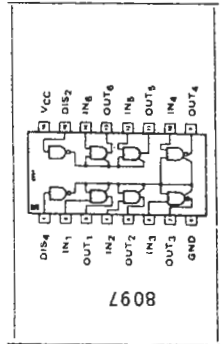
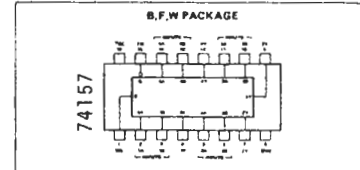
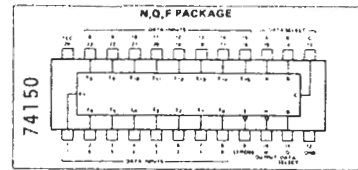
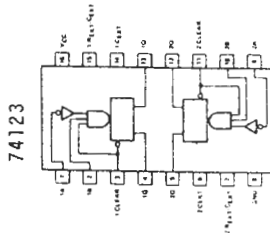
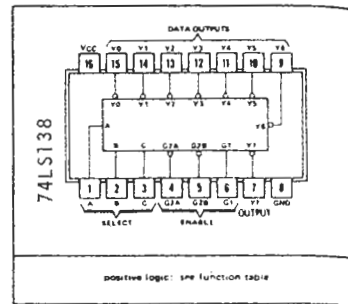
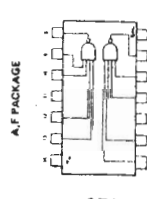
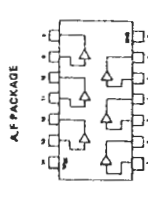
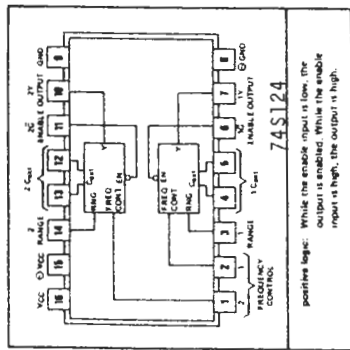
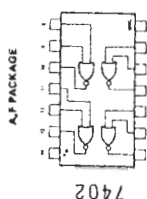
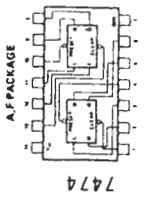
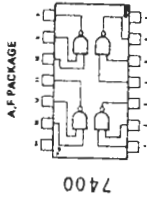

Logic Diagram

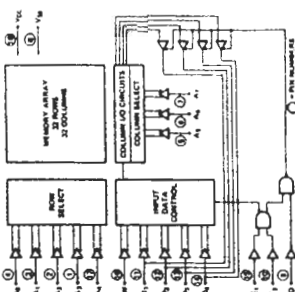
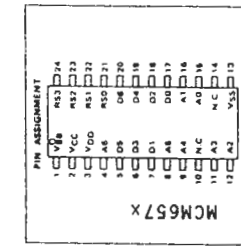
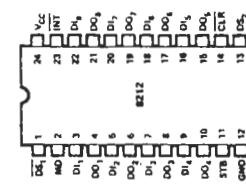
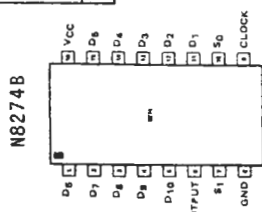
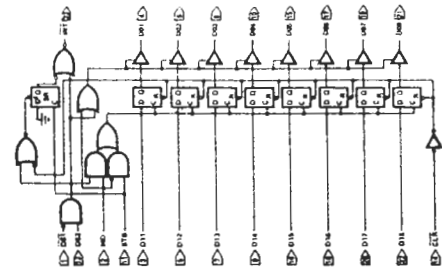
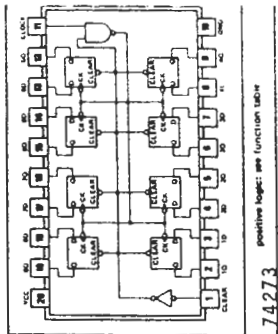
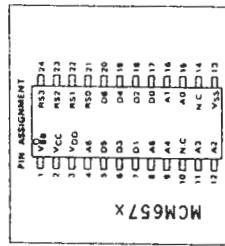
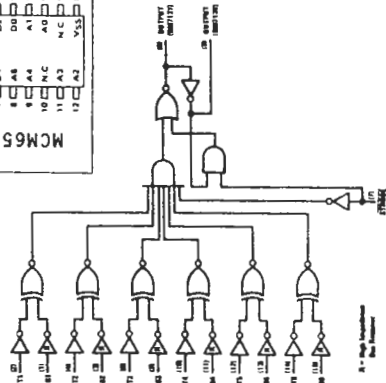

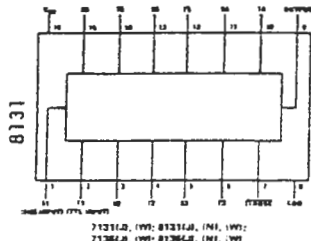
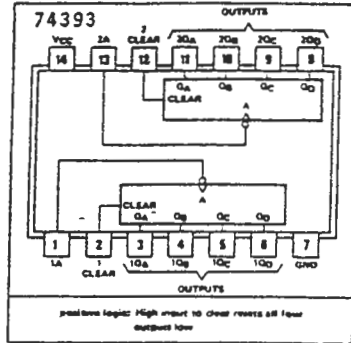
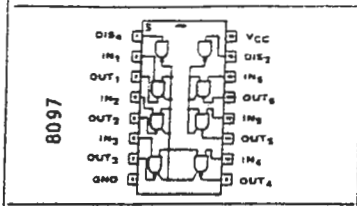

Logic Diagram

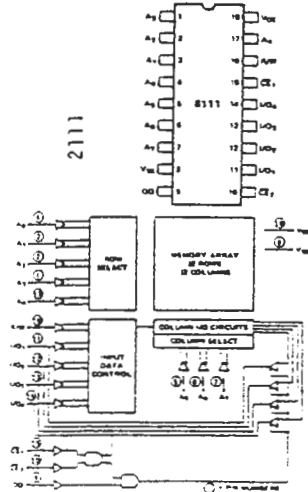
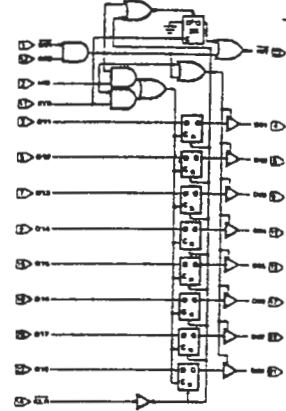
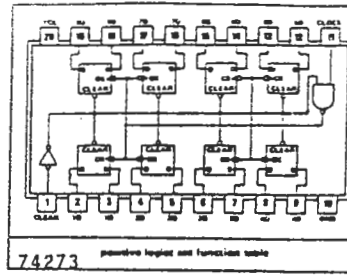
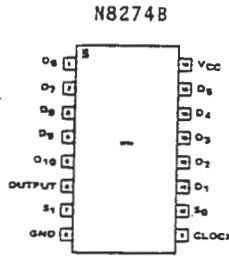
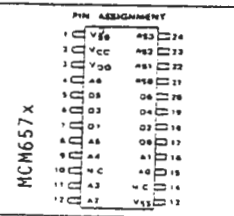
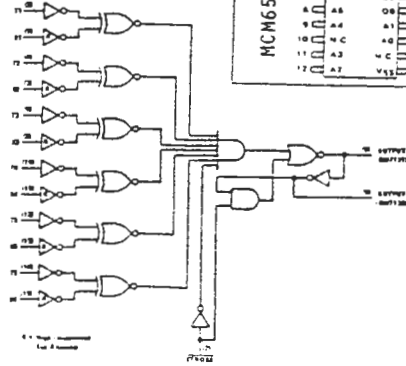

APPENDIX B: Chip pinouts

B-4

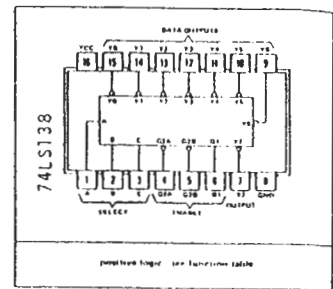
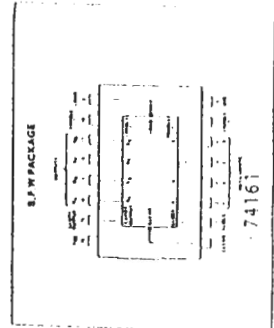
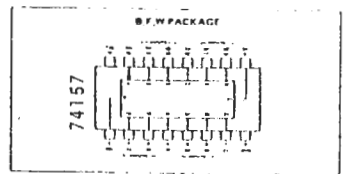
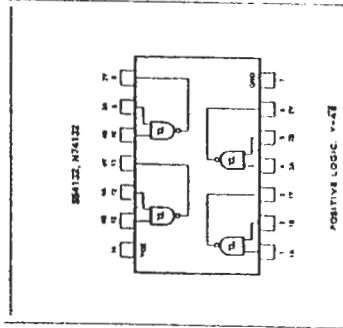
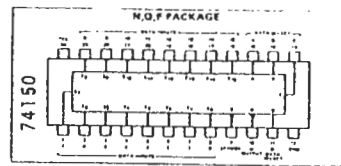
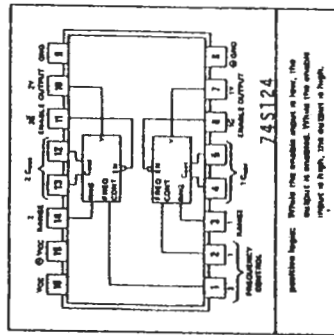
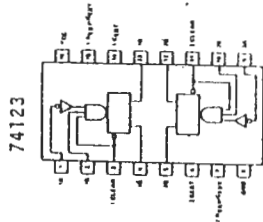
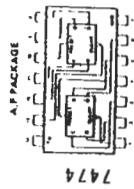
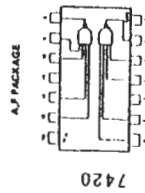
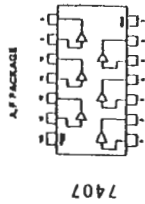
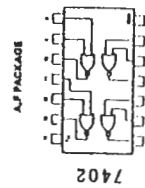
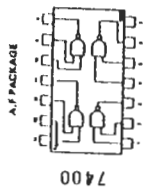

APPENDIX B: Chip pinouts

P. 8-2

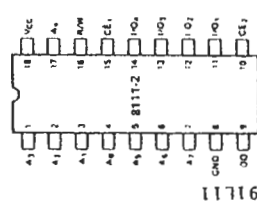
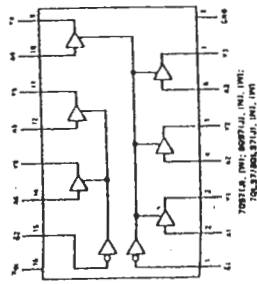
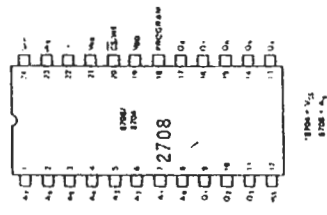
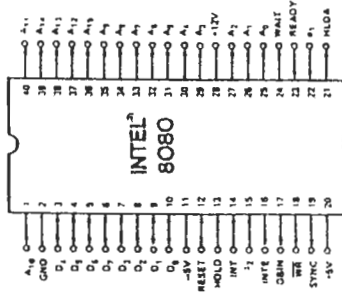

PIN CONFIGURATION

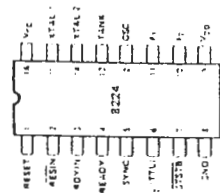

BLOCK DIAGRAM

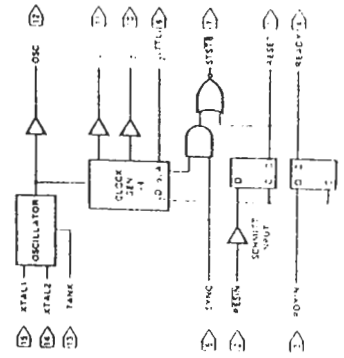

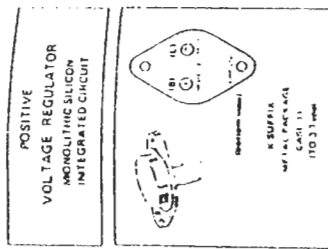

POSITIVE 500 mA - MC7800 Series
 Power Dissipation: 0.16 (175°C Junction Temperature)
 I_D - 500 mA (Max)
 V_O - 15% of nominal voltage for all line and load regulation limits.

| Model | V _I (Max) | V _O (Max) | Dropout Type |
|--------|----------------------|----------------------|--------------|
| MC7805 | 35 V | 5 V | MC7805C |
| MC7806 | 35 V | 6 V | MC7806C |
| MC7809 | 35 V | 9 V | MC7809C |
| MC7812 | 35 V | 12 V | MC7812C |
| MC7815 | 35 V | 15 V | MC7815C |
| MC7818 | 35 V | 18 V | MC7818C |
| MC7824 | 35 V | 24 V | MC7824C |

NEGATIVE 100 mA - MC7900 Series
 Power Dissipation: 0.16 (175°C Junction Temperature)
 I_D - 100 mA (Max)
 V_O - 15% of nominal voltage for all line and load regulation limits.

| Model | V _I (Max) | V _O (Max) | Dropout Type |
|--------|----------------------|----------------------|--------------|
| MC7905 | 35 V | -5 V | MC7905C |
| MC7906 | 35 V | -6 V | MC7906C |
| MC7909 | 35 V | -9 V | MC7909C |
| MC7912 | 35 V | -12 V | MC7912C |
| MC7915 | 35 V | -15 V | MC7915C |
| MC7918 | 35 V | -18 V | MC7918C |
| MC7924 | 35 V | -24 V | MC7924C |

NEGATIVE 1.5 A - MC7900 Series
 Power Dissipation: 0.16 (175°C Junction Temperature)
 I_D - 1.5 A (Max)
 V_O - 15% of nominal voltage for all line and load regulation limits.

| Model | V _I (Max) | V _O (Max) | Dropout Type |
|--------|----------------------|----------------------|--------------|
| MC7905 | 35 V | -5 V | MC7905C |
| MC7906 | 35 V | -6 V | MC7906C |
| MC7909 | 35 V | -9 V | MC7909C |
| MC7912 | 35 V | -12 V | MC7912C |
| MC7915 | 35 V | -15 V | MC7915C |
| MC7918 | 35 V | -18 V | MC7918C |
| MC7924 | 35 V | -24 V | MC7924C |

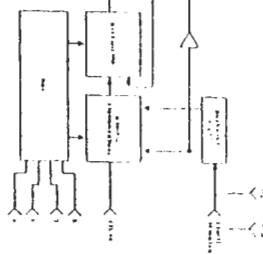
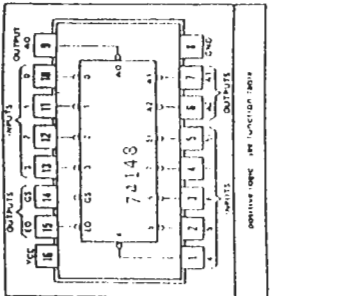
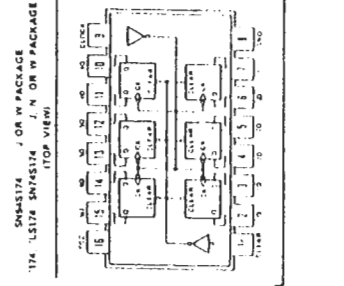
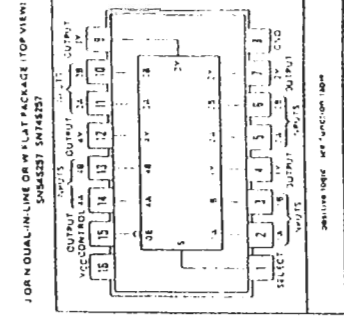
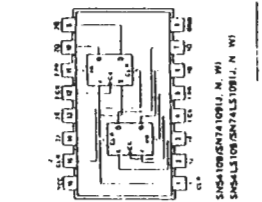
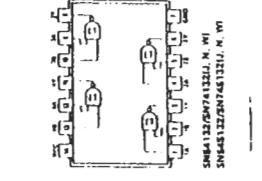
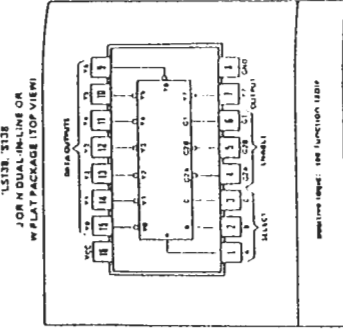
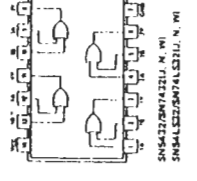
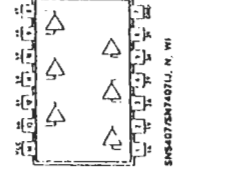
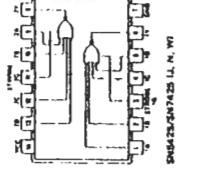
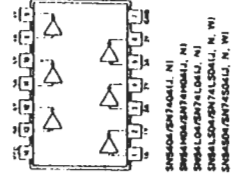
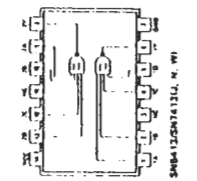
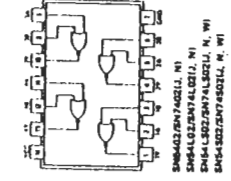
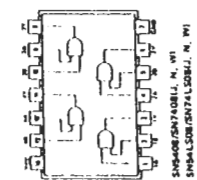
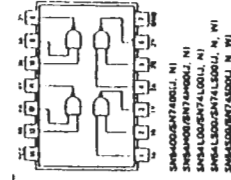
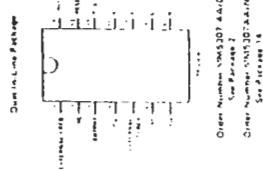

Order Number: SN5407 440
 See Package 7
 Order Number: SN54130-143N
 See Package 14

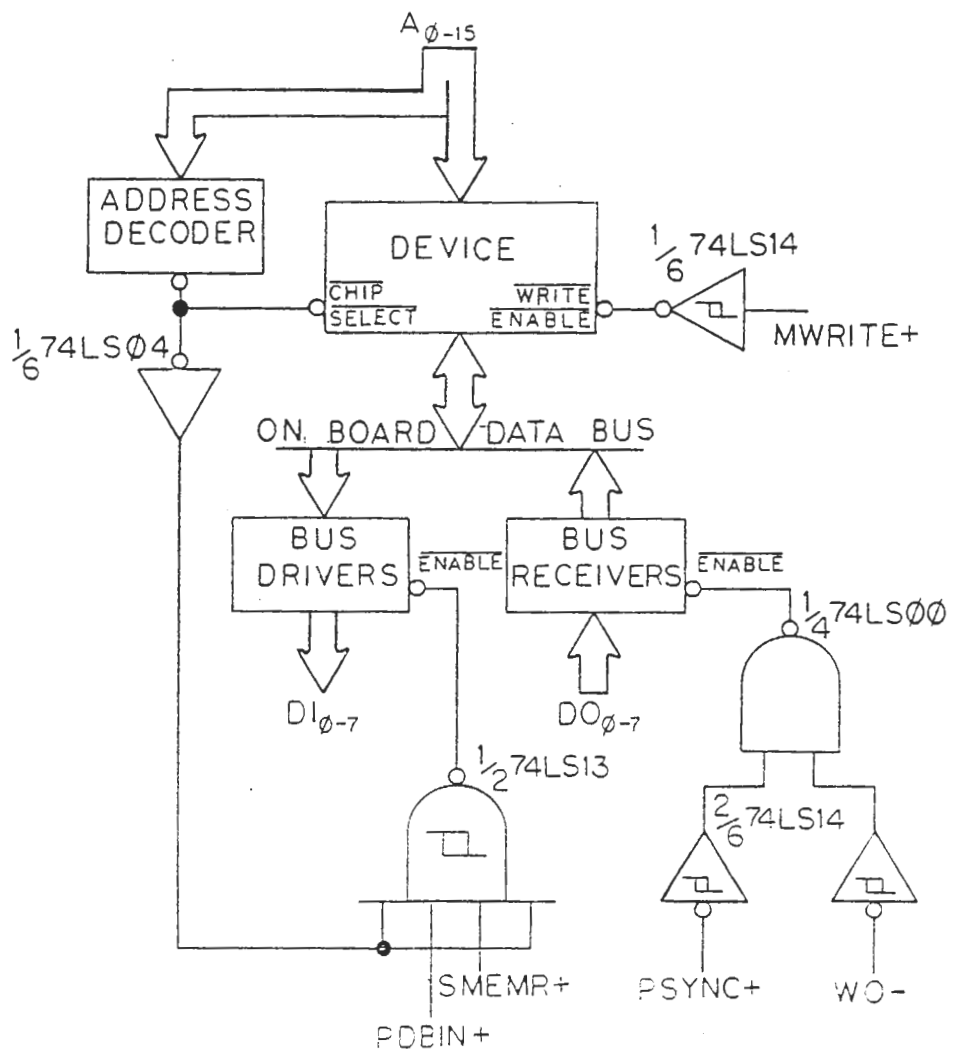

FIG X