

# Heathkit® Manual

*for the*

## **SERIAL I/O AND CASSETTE INTERFACE CARD**

**Model H8-5**

595-2032-03

**HEATH COMPANY**  
BENTON HARBOR, MICHIGAN 49022

**Copyright © 1977**  
Heath Company  
*All Rights Reserved*  
Printed in the United States of America



## TABLE OF CONTENTS

INTRODUCTION.....	3	SPECIFICATIONS.....	56
PARTS LIST.....	4	CIRCUIT DESCRIPTION.....	57
STEP-BY-STEP ASSEMBLY.....	7	CIRCUIT BOARD X-RAY	
Circuit Board.....	7	VIEW.....	(Illustration Booklet, Page 6)
Jumper Options.....	27	SEMICONDUCTOR IDENTIFICATION	
Cable Assembly.....	30	CHARTS.....	62
Cable Connections.....	37		
INSTALLATION AND ADJUSTMENTS.....	38	SCHMATIC.....	Fold-in
OPERATION.....	43		
IN CASE OF DIFFICULTY.....	54	WARRANTY.....	Inside front cover
Troubleshooting and Repair		CUSTOMER SERVICE.....	Inside rear cover
Precautions.....	54		
Troubleshooting Chart.....	55		

HEATH

Schlumberger

HEATH COMPANY  
BENTON HARBOR, MICHIGAN 49022

## IMPORTANT NOTICE

Please make the following changes in your Manual before you begin assembly.

Page 12 — Left column, ninth step down (sixth step up from the bottom). Change the step to read:

( ) Do not install a part at this location at this time.

Page 28 — Remove Page 28 from this Notice and tape it over Page 28 in your Manual.

Schematic Diagram — Locate resistor R152 near the upper middle section of your schematic diagram. Place an asterisk (\*) near the resistor. Then add the following Note to the upper left corner of your schematic.

8 \* Use for 20 mA active or passive current loop.

Thank you,

HEATH COMPANY

## INTRODUCTION

Your Heathkit Model H8-5 Serial I/O and Cassette Interface Card provides you with two input/output ports to the Heath H8 Computer. One port provides a cassette tape interface while the other port provides a serial I/O port. The card plugs easily into the mother circuit board in the H8 Computer.

The cassette tape interface, along with the H8 front panel monitor, provides you with a fully automated Load and Dump facility. This greatly increases the system's usefulness by enabling you to store programs and data for later use. The interface will automatically compensate for variations in tape speed and will accept a wide range of input levels. Both high and low level outputs are provided to match any tape unit you may wish to use. The interface operates at either 300 or 1200 Baud and uses 2400 and 1200 Hz tones for Mark and Space respectively. A separate automatic motor control allows two tape recorders to simultaneously record (DUMP) and playback (LOAD). With this feature, you can edit either program or data files. A built-in timer will automatically delay recording until the recorder's motor attains its normal operating speed.

The serial I/O port normally operates with the system console. It provides serial communications at speeds from 110 to 9600 Baud at either 20 mA or RS-232 compatible levels. You can wire the 20 mA loop in either the active or passive mode. You can also select the data rates for receive and transmit independently from any of eight rates. These rates are derived from a crystal oscillator which provides excellent system stability. A software programmable USART allows control of port configurations by the user's program.

Each port has four interrupt flags which you can connect to your system's interrupt structure in several ways. This feature, and the USART, makes these ports very flexible.

The interface employs a port interchange switch. This allows you to dump and load data through a teletypewriter terminal as well as to a magnetic tape recorder.

A built-in logic probe is provided for the two initial adjustments needed. You can also use the logic probe for any future testing. No additional equipment is required since all signal sources are provided.

**NOTE:** Be sure you build the H8 Computer first, the memory board second, the H9 Terminal third, and the Serial I/O and Cassette Interface Card last.

## PARTS LIST

Each circuit part in an electronic kit has its own component number (R2, C4, etc.). Use these numbers when you want to identify the same part in the various sections of the Manual. These numbers, which are especially useful if a part has to be replaced, appear:

- In the Parts List,
- At the beginning of each step where a component is installed,
- In some illustrations,
- In the Schematic,
- In the sections at the rear of the Manual.

A separate "Illustration Booklet" contains numbered illustrations (Pictorials, Details, etc.) that are too large for the Assembly Manual. The Step-by-Step Assem-

bly instructions will direct you to the proper illustration in the Booklet. After you complete the assembly of your kit, place the Illustration Booklet with the Assembly Manual and save it for future reference.

Check each part against the following list and the Parts Pictorial (Illustration Booklet, Page 1). Any part that is packed in an individual envelope with the part number on it should be placed back in the envelope after you identify it until it is called for in a step. Do not discard any packing materials until all parts are accounted for.

To order a replacement part, always include the PART NUMBER. Use the Parts Order Form furnished with this kit or at the rear of this Manual. If a Parts Order Form is not available, refer to "Replacement Parts" inside the rear cover. Your Warranty is inside the front cover. For prices, refer to the separate "Heath Parts Price List."

KEY No.	HEATH Part No.	QTY.	DESCRIPTION	CIRCUIT Comp. No.
---------	----------------	------	-------------	-------------------

### RESISTORS

NOTE: The following resistors have a tolerance of 10% unless they are listed otherwise. 10% is indicated by a fourth color band of silver; 5% is indicated by a gold fourth band. The resistors may be packed in more than one envelope.

#### 1/4-Watt

A1	1-2-12	6	1000 $\Omega$ (brown-black-red)	R103, R104, R109, R123, R138, R149
A1	1-6-12	2	3300 $\Omega$ (orange-orange-red)	R107, R161
A1	1-8-12	11	4700 $\Omega$ (yellow-violet-red)	R124, R125, R126, R130, R134, R148, R153, R154, R155, R156, R157
A1	1-9-12	14	10 k $\Omega$ (brown-black-orange)	R102, R105, R111, R112, R115, R116, R117, R129, R133, R137, R159, R162, R163, R164
A1	1-11-12	1	47 k $\Omega$ (yellow-violet-orange)	R118
A1	1-31-12	1	68 k $\Omega$ (blue-gray-orange)	R146

KEY No.	HEATH Part No.	QTY.	DESCRIPTION	CIRCUIT Comp. No.
---------	----------------	------	-------------	-------------------

### Resistors (cont'd.)

A1	1-84-12	6	100 k $\Omega$ (brown-black-yellow)	R106, R108, R122, R135, R136, R158
A1	1-47-12	1	150 k $\Omega$ (brown-green-yellow)	R132
A1	1-19-12	1	1 M $\Omega$ (brown-black-green)	R121

#### 1/2-Watt

A2	1-134	2	3.9 $\Omega$ , 5% (orange-white-gold-gold)	R127, R128
A2	1-123	2	100 $\Omega$ , 5% (brown-black-brown)	R101, R131
A2	1-66	2	150 $\Omega$ , 5% (brown-green-brown)	R139, R147
A2	1-95	1	560 $\Omega$ , 5% (green-blue-brown)	R165
A2	1-52	6	680 $\Omega$ , 5% (blue-gray-brown)	R141, R142, R143, R144, R151, R152
A2	1-44	1	2200 $\Omega$ , 5% (red-red-red)	R145

### Other Resistor

A3	2-662-12	1	7500 $\Omega$ (7.5 k) 1/4-watt, 1%, precision	R114
----	----------	---	---	------

KEY No.	HEATH Part No.	QTY.	DESCRIPTION	CIRCUIT Comp. No.
<b>CAPACITORS</b>				
B1	21-6	1	27 pF ceramic	C113
B1	21-163	3	1000 pF (.001) ceramic	C103, C104, C106
B1	21-27	1	5000 pF (.005) ceramic	C112
B1	21-176	1	.01 $\mu$ F ceramic	C114
B1	21-95	12	.1 $\mu$ F ceramic	C115, C116, C117, C119, C121, C122, C123, C124, C125, C127, C128, C129
B2	25-221	3	2.2 $\mu$ F tantalum	C102, C109, C131
B2	25-253	1	33 $\mu$ F tantalum	C111
B3	27-73	1	.047 $\mu$ F Mylar*	C101
B3	27-77	2	.1 $\mu$ F Mylar	C105, C108
B4	29-5	1	1000 pF (.001) polystyrene	C107 (300 baud)
B5	20-111	1	230 pF mica	C107 (1200 baud)

**DIODES — TRANSISTORS — IC'S**

C1	56-56	7	1N4149 diode	D101, D102, D103, D105, D106, D107, D108
C2	412-611	1	LED	LED101

NOTE: Transistors (and integrated circuits) are marked for identification in one of the following four ways:

1. Part number.
2. Type number. (On integrated circuits this refers only to the numbers and letters in bold type. Disregard any other numbers or letters.)
3. Part number and type number.
4. Part number with a type number other than the one shown.

**IMPORTANT: If any components are missing from the sealed IC package, return the unopened package for replacement. Claims for missing IC's will not be honored if the package has been opened.**

If you locate damaged or defective IC's, order individual replacements. Be sure to follow the standard instructions on the "Parts Order Form" and on the inside rear cover of the Manual. Save defective or damaged components for return instructions.

**CAUTION:** The integrated circuits packed in conductive foam can be damaged by static voltage. Since these parts represent a considerable portion of the cost of the kit, do not remove them from their packages until you are instructed to do so.

KEY No.	HEATH Part No.	QTY.	DESCRIPTION	CIRCUIT Comp. No.
<b>Diodes — Transistors — Integrated Circuits (cont'd.)</b>				
C3	417-821	5	MPSA06 transistor	Q101, Q102, Q105, Q106, Q107
C3	417-865	1	MPSA55 transistor	Q103
C3	417-897	1	FET (selected)	Q104
C4	442-54	1	$\mu$ 7805 integrated circuit	IC133
C5	443-808	2	4N26 integrated circuit	IC119, IC121
C6	442-616	1	LM3302N, LM2901, or $\mu$ A775 integrated circuit	IC102
C6	443-18	1	SN7404N integrated circuit	IC112
C6	443-45	1	SN7408N integrated circuit	IC117
C6	443-54	2	SN7403N integrated circuit	IC128, IC129
C6	443-640	3	SN7493AN integrated circuit	IC115, IC116, IC107
C6	443-728	3	SN74LS00N integrated circuit	IC108, IC118, IC122
C6	443-730	2	SN74LS74N integrated circuit	IC104, IC105
C6	443-858	1	SN7414N integrated circuit	IC127
C6	443-828	1	SN74LS73N integrated circuit	IC111
C7	442-647	1	CD4046E integrated circuit	IC106
C7	443-53	1	SN7442N integrated circuit	IC125
C7	443-90	2	SN74123N integrated circuit	IC101, IC103
C7	443-757	2	SN74LS161 integrated circuit	IC113, IC114
C7	443-822	1	SN74LS139 integrated circuit	IC126
C8	443-754	2	SN74LS240N integrated circuit	IC131, IC132
C9	443-776	2	8251 integrated circuit	IC123, IC124

**CONTROLS — INDUCTOR — SWITCHES**

D1	10-311	1	5000 $\Omega$ (5 k) control	R113
D1	10-317	1	200 k $\Omega$ control	R119
D2	40-961	1	100 $\mu$ H coil	L101
D3	40-1667	2	Inductor	(Part of reed relay)
D4	60-604	1	Slide switch	SW101
D5	65-49	2	Reed switch	RL101, RL102

**CONNECTORS**

E1	432-147	1	15-hole female connector shell	S102
E2	432-146	1	15-hole male connector shell	P103
E3	432-854	16	Round male pin	
E4	432-855	16	Female pin	
E5	432-865	1	3-hole connector shell	
E6	432-866	20	Spring connectors	
E7	432-903	1	10-pin circuit board connector	P102



KEY No.	HEATH Part No.	QTY.	DESCRIPTION	CIRCUIT Comp. No.
---------	----------------	------	-------------	-------------------

**Connectors (cont'd.)**

E8	432-932	5	Circuit board pin	TP1, TL, TP2, TP3, TP4
E9	432-947	2	25-pin connector	S101
E10	432-958	1	10-hole connector shell	S102
E11	432-969	1	5-pin circuit board connector	P101
E12	432-970	1	5-pin connector shell	
E13	266-966	1	Connector key	

**SOCKETS — PLUGS**

F1	434-186	2	Phono socket	IN, OUT
F2	434-298	15	14-pin socket	
F3	434-299	8	16-pin socket	
F4	434-311	2	20-pin socket	
F5	434-312	2	28-pin socket	
F6	438-4	2	Phono plug	P104, P105
F7	438-26	2	Red phone plug	P106, P107
F8	438-52	2	Subminiature phone plug	P108, P109

**HARDWARE**

G1	250-56	5	6-32 x 1/4" screw
G2	252-3	3	6-32 nut
G3	254-1	3	#6 lockwasher

KEY No.	HEATH Part No.	QTY.	DESCRIPTION	CIRCUIT Comp. No.
---------	----------------	------	-------------	-------------------

**WIRE — TUBING — CABLE**

343-11	8'	Shielded wire
344-59	3'	Solid white wire
344-111	3'	Orange stranded wire
344-120	3'	Black stranded wire
344-121	3'	White stranded wire
346-67	3'	Heat-shrinkable tubing
347-1	4'	Round 8-wire cable
347-55	2'	Flat 8-wire cable
347-60	8'	2-wire cable

**MISCELLANEOUS**

73-151	1-3/4"	Tape		
85-2110-2	1	Circuit board		
H1	204-2308	1	Bracket	
H2	352-13	1	Silicone grease	
H3	391-34	1	Blue and white label	
H4	404-536	1	4.0 MHz crystal	Y101
448-253	1	Blank cassette		
490-185	1	Solder braid		
597-260	1	Solder		
		Parts Order Form		
		Assembly Manual		
		(See Page 1 for part number.)		

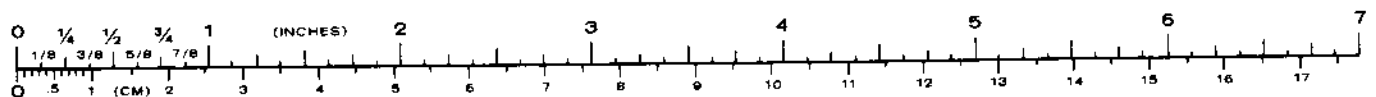

CIRCUIT BOARD

STEP-BY-STEP ASSEMBLY

START

( ) Remove the insulation from 2" of white wire. Cut the bare wire into two 1" lengths and install them. Solder the wire ends to the foil and cut off the excess lengths.

NOTE: The parts installed in this Pictorial are in the shaded area of the identification drawing. Position the circuit board with the white printed side up and proceed with the following steps.

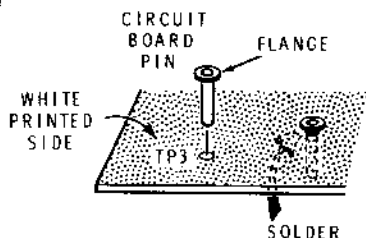

To install the circuit board pins in the following steps, push the pins into the indicated circuit board locations as shown. Then solder the pins to the foil on the opposite side of the circuit board.

Install a circuit board pin (#432-932) at each of the following locations:

- ( ) TP3. ....
- ( ) TL. ....
- ( ) TP4. ....
- ( ) TP2. ....
- ( ) TP1. ....

IDENTIFICATION DRAWING

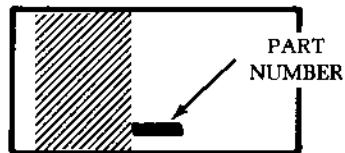

The steps performed in this Pictorial are in this area of the circuit board.

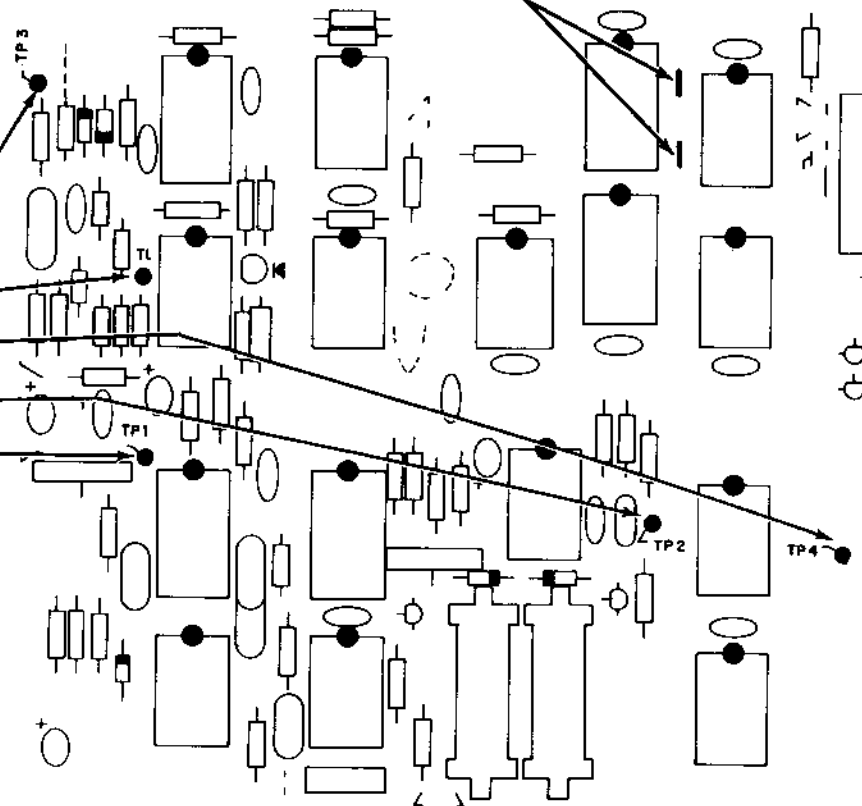

PICTORIAL 1-1



**START**

( ) R111: 10 k $\Omega$  (brown-black-orange).

( ) R109: 1000  $\Omega$  (brown-black-red).

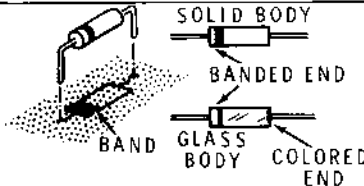

If your diode has a solid body, the band is clearly defined. If your diode has a glass body, do not mistake the colored end inside the diode for the banded end. Look for a band painted on the outside of the glass.

**NOTE:** When you install diodes, as in the following steps, be sure you position the banded end of each diode as it is shown on the circuit board. See Detail 1-2A.

( ) D102: 1N4149 diode (#56-56).

( ) D101: 1N4149 diode (#56-56).

( ) R101: 100  $\Omega$ , 1/2-watt, 5% (brown-black-brown).

( ) R102: 10 k $\Omega$  (brown-black-orange).

( ) R106: 100 k $\Omega$ , 5% (brown-black-yellow).

( ) R107: 3300  $\Omega$  (orange-orange-red).

( ) R105: 10 k $\Omega$  (brown-black-orange).

( ) R103: 1000  $\Omega$  (brown-black-red).

( ) R132: 150 k $\Omega$  (brown-green-yellow).

( ) Solder the leads to the foil and cut off the excess lead lengths.

IDENTIFICATION DRAWING

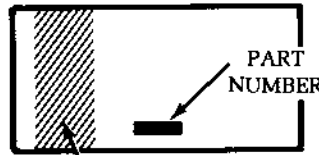

The steps performed in this Pictorial are in this area of the circuit board.

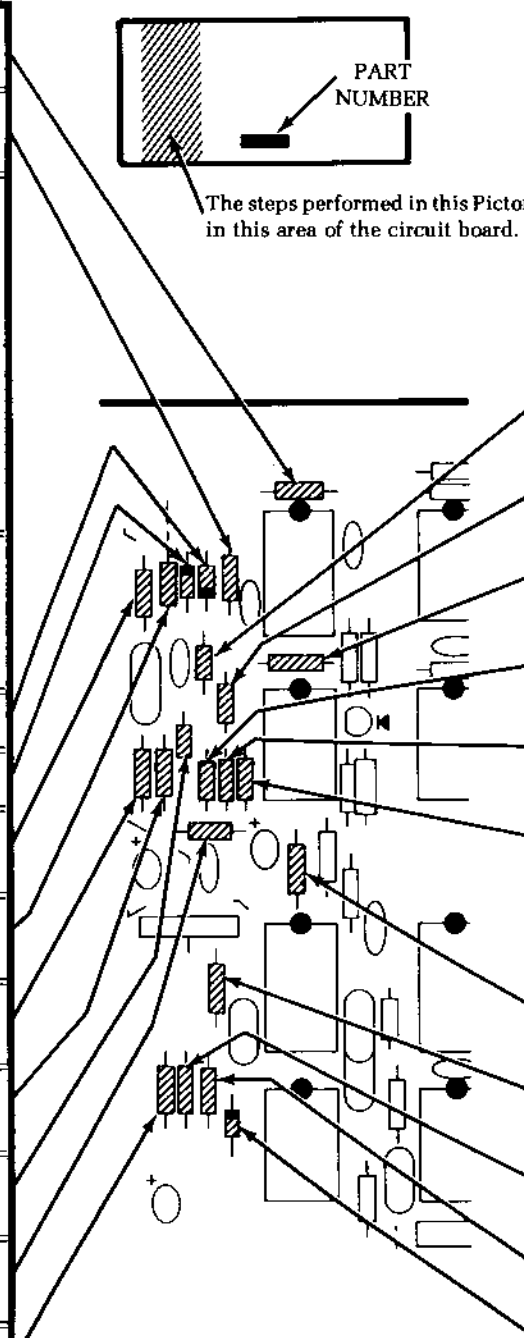

**CONTINUE**

( ) R162: 10 k $\Omega$  (brown-black-orange).

( ) R159: 10 k $\Omega$  (brown-black-orange).

( ) R112: 10 k $\Omega$  (brown-black-orange).

( ) R108: 100 k $\Omega$ , 5% (brown-black-yellow).

( ) R161: 3300  $\Omega$  (orange-orange-red).

( ) R158: 100 k $\Omega$ , 5% (brown-black-yellow).

( ) Solder the leads to the foil and cut off the excess lead lengths.

( ) R104: 1000  $\Omega$  (brown-black-red).

( ) R114: 7500 $\Omega$  (7.5 k), 1/4-watt, 1%, precision.

( ) R129: 10 k $\Omega$  (brown-black-orange).

( ) R131: 100  $\Omega$ , 1/2-watt, 5% (brown-black-brown.)

( ) D103: 1N4149 diode (#56-56).

( ) Solder the leads to the foil and cut off the excess lead lengths.

**PICTORIAL 1-2**

IMPORTANT: THE BANDED END OF DIODES CAN BE MARKED IN A NUMBER OF WAYS.

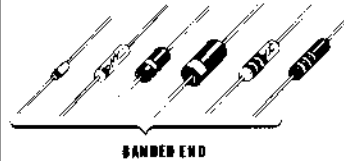

Detail 1-2A

IDENTIFICATION  
DRAWING

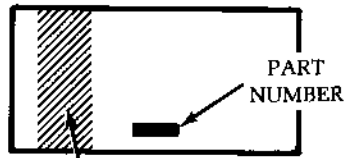

The steps performed in this Pictorial are in this area of the circuit board.

**START** →

- ( ) R135: 100 kΩ, 5% (brown-black-yellow).
- ( ) R133: 10 kΩ (brown-black-orange).
- ( ) R165: 560 Ω, 1/2-watt, 5% (green-blue-brown).
- ( ) R163: 10 kΩ (brown-black-orange).
- ( ) R164: 10 kΩ (brown-black-orange).
- ( ) R115: 10 kΩ (brown-black-orange).
- ( ) R122: 100 kΩ, 5% (brown-black-yellow).
- ( ) R123: 1000 Ω (brown-black-red).
- ( ) R127: 3.9 Ω, 1/2-watt, 5% (orange-white-gold-gold).
- ( ) Solder the leads to the foils and cut off the excess lead lengths.

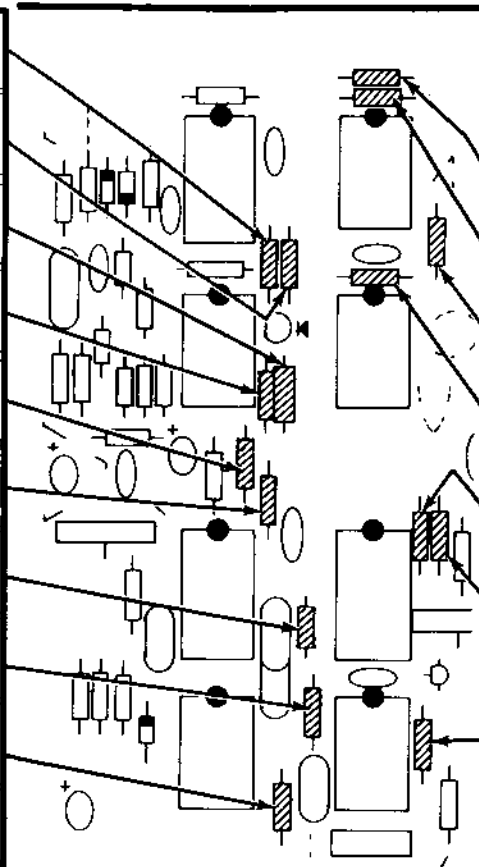

**CONTINUE** →

- ( ) R134: 4700 Ω (yellow-violet-red).
- ( ) R130: 4700 Ω (yellow-violet-red).
- ( ) R137: 10 kΩ (brown-black-orange).
- ( ) R117: 10 kΩ (brown-black-orange).
- ( ) R121: 1 MΩ (brown-black-green).
- ( ) R118: 47 kΩ (yellow-violet-orange).
- ( ) R116: 10 kΩ (brown-black-orange).
- ( ) Solder the leads to the foil and cut off the excess lead lengths.

**PICTORIAL 1-3**

IDENTIFICATION  
DRAWING

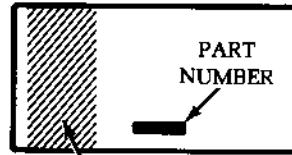

The steps performed in this Pictorial are in this area of the circuit board.

**START**

NOTE: 14-pin, 16-pin, 20-pin, and 28-pin IC sockets are used in this kit. Be very careful when you install the sockets, as it is possible to place a 14-pin socket in a 16-pin socket location by mistake. Make sure all pins are straight and insert the socket pins into the circuit board holes. The index mark on the circuit board must still be visible after it is installed. Solder the pins to the foil.

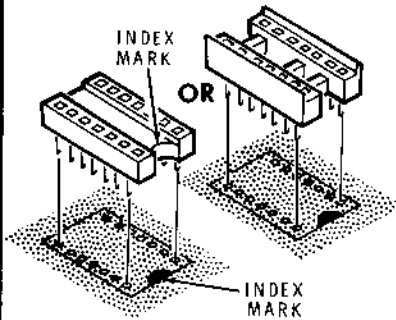

16-pin IC socket at location IC101.

14-pin IC sockets at the following locations:

IC102.....

IC107.....

IC108.....

16-pin IC sockets at the following locations:

IC103.....

IC106.....

14-pin IC socket at location IC104.

14-pin IC socket at location IC105.

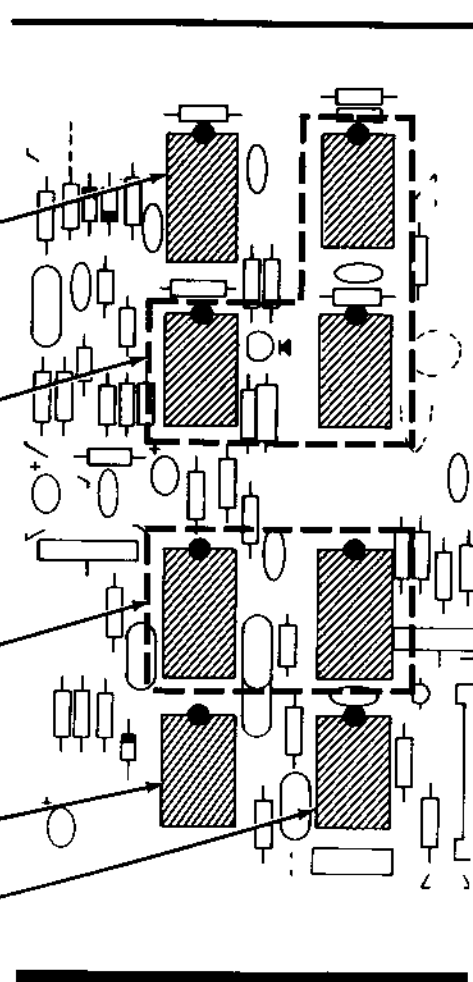

PICTORIAL 1-4

IDENTIFICATION  
DRAWING

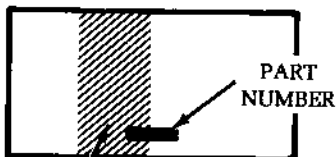

The steps performed in this Pictorial are in this area of the circuit board.

START

- R138: 1000  $\Omega$  (brown-black-red).
- R136: 100 k $\Omega$ , 5% (brown-black-yellow).
- 14-pin IC sockets at the following locations:
  - IC112.....
  - IC111.....
- R125: 4700  $\Omega$  (yellow-violet-red).
- R126: 4700  $\Omega$  (yellow-violet-red).
- D105: 1N4149 diode (#56-56).
- D106: 1N4149 diode (#56-56).
- R128: 3.9  $\Omega$ , 1/2-watt, 5% (orange-white-gold-gold).
- Solder the leads to the foil and cut off the excess lead lengths.

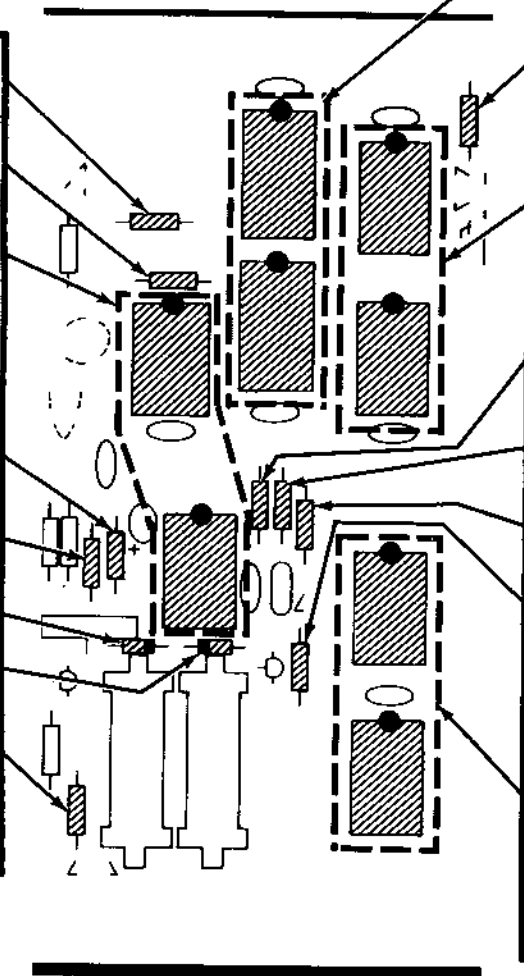

CONTINUE

- 16-pin IC sockets at the following locations:
  - IC113.
  - IC114.
- R145: 2200  $\Omega$ , 1/2-watt (red-red-red).
- 14-pin IC sockets at the following locations:
  - IC115.
  - IC116.
- R141: 680  $\Omega$ , 1/2-watt, 5% (blue-gray-brown).
- R142: 680  $\Omega$  1/2-watt, 5% (blue-gray-brown).
- R139: 150  $\Omega$ , 1/2-watt (brown-green-brown).
- R124: 4700  $\Omega$  (yellow-violet-red).
- Solder the leads to the foil and cut off the excess lead lengths.
- 14-pin IC sockets at the following locations:
  - IC117.
  - IC118.

PICTORIAL 1-5

IDENTIFICATION  
DRAWING



The steps performed in this Pictorial are in this area of the circuit board.

**START**

- ( ) R147: 150  $\Omega$ , 1/2-watt (brown-green-brown).
- ( ) R148: 4700  $\Omega$  (yellow-violet-red).
- ( ) R144: 680  $\Omega$ , 1/2-watt, 5% (blue-gray-brown).
- ( ) R143: 680  $\Omega$ , 1/2-watt, 5% (blue-gray-brown).
- ( ) R146: 68 k $\Omega$  (blue-gray-orange).
- ( ) D107: 1N4149 diode (#56-56).
- ( ) Solder the leads to the foil and cut off the excess lead lengths.
- ( ) D108: 1N4149 diode (#56-56).
- ( ) R152: 680  $\Omega$ , 1/2-watt, 5% (blue-gray-brown).
- ( ) R151: 680  $\Omega$ , 1/2-watt, 5% (blue-gray-brown).
- ( ) R155: 4700  $\Omega$  (yellow-violet-red).
- ( ) R154: 4700  $\Omega$  (yellow-violet-red).
- ( ) 14-pin IC socket at location IC122.
- ( ) Solder the leads to the foil and cut off the excess lead lengths.
- ( ) Turn the circuit board over and solder a cutoff component lead between pins 12 and 13 of IC122. Then cut off the excess lead lengths.

**CONTINUE**

- NOTE: The following IC socket will count as two IC sockets:
- ( ) 16-pin IC socket at location IC119 and IC121.
  - ( ) R149: 1000  $\Omega$  (brown-black-red).
  - ( ) R153: 4700  $\Omega$  (yellow-violet-red).
  - ( ) 16-pin IC socket at location IC125.
- 28-pin IC sockets at the following IC locations:
- ( ) IC123.
  - ( ) IC124.
  - ( ) Solder the leads to the foil and cut off the excess lead lengths.

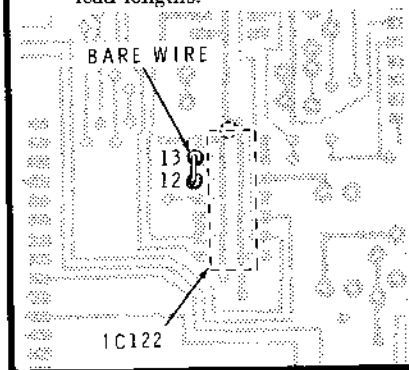
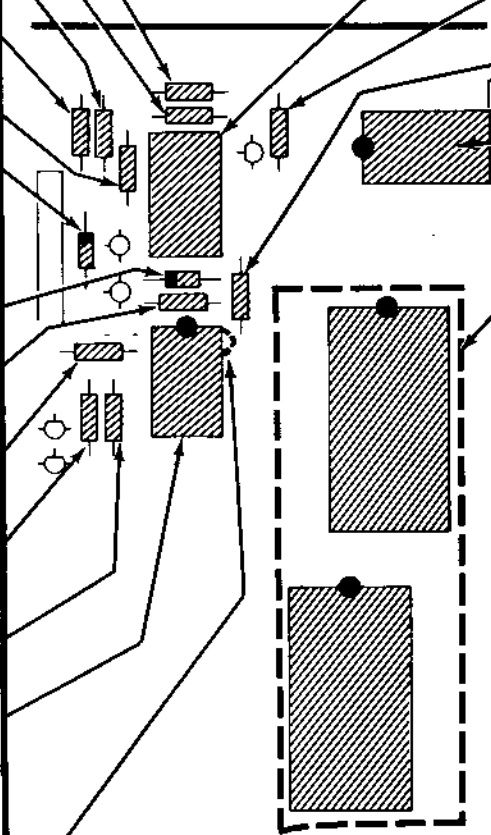

PICTORIAL 1-6

IDENTIFICATION  
DRAWING

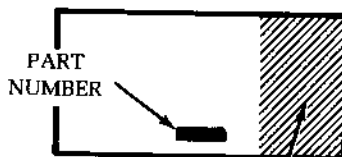

The steps performed in this Pictorial are in this area of the circuit board.

**START** →

16-pin IC socket at location IC126.

14-pin IC socket at location IC127.

R156: 4700 Ω (yellow-violet-red).

14-pin IC sockets at the following IC locations:

IC128. ....

IC129. ....

R157: 4700 Ω (yellow-violet-red).

Solder the leads to the foil and cut off the excess lead lengths.

20-pin IC sockets at the following IC locations:

IC131. ....

IC132. ....

Carefully check each socket for solder bridges between pins. If a solder bridge has occurred, hold the circuit board foil-side-down as shown, and hold the soldering iron tip between the two points that are bridged. The solder will flow down the soldering iron tip.

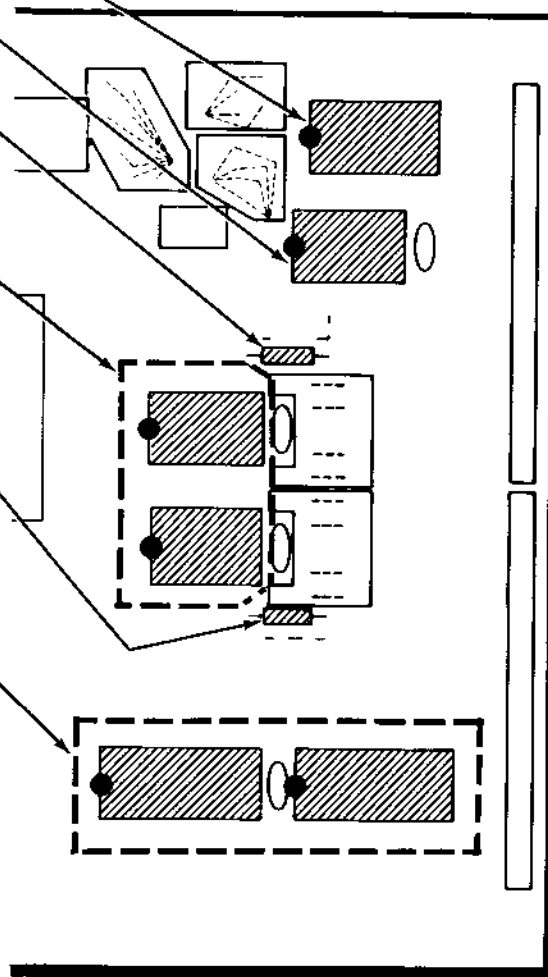
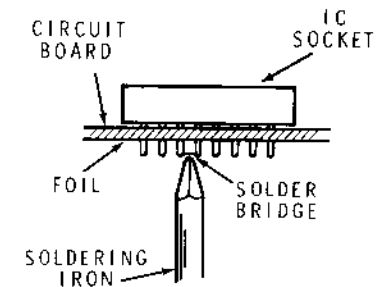

PICTORIAL 1-7

**START**

NOTE: When you install the following transistor, position the flat or wide space of the transistor over the outline on the circuit board as shown. Then insert the transistor leads into their correct S, D, and G holes. Solder the leads to the foil and cut off the excess lead lengths as you install each transistor.

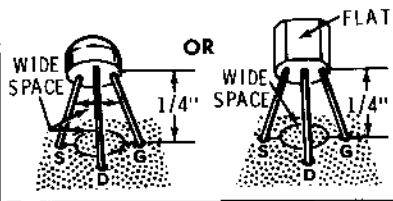

( ) Q104: FET (selected) (#417-897).

NOTE: When you install each of the following transistors, position the flat of the transistor over the outline of the flat on the circuit board. Then insert the transistor leads into their correct E, B, and C holes. Solder the leads to the foil and cut off the excess lead lengths.

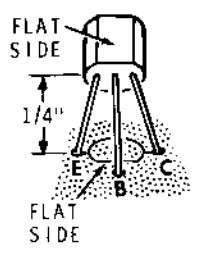

( ) Q106: MPSA06 transistor (#417-821).

( ) Q107: MPSA06 transistor (#417-821).

( ) Q102: MPSA06 transistor (#417-821).

( ) Q101: MPSA06 transistor (#417-821).

( ) Q105: MPSA06 transistor (#417-821).

IDENTIFICATION DRAWING

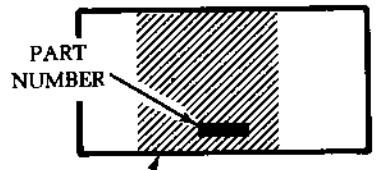

The steps performed in this Pictorial are in this area of the circuit board.

**CONTINUE**

NOTE: When you install the following transistor, position the flat or wide space of the transistor over the outline on the circuit board as shown. Then insert the transistor leads into their correct E, B, and C holes. Solder the leads to the foil and cut off the excess lead lengths as you install each transistor.

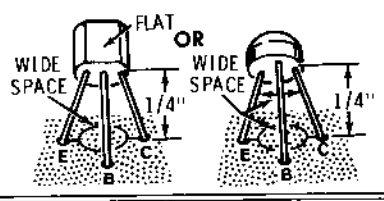

( ) Q103: MPSA55 transistor (#417-865).

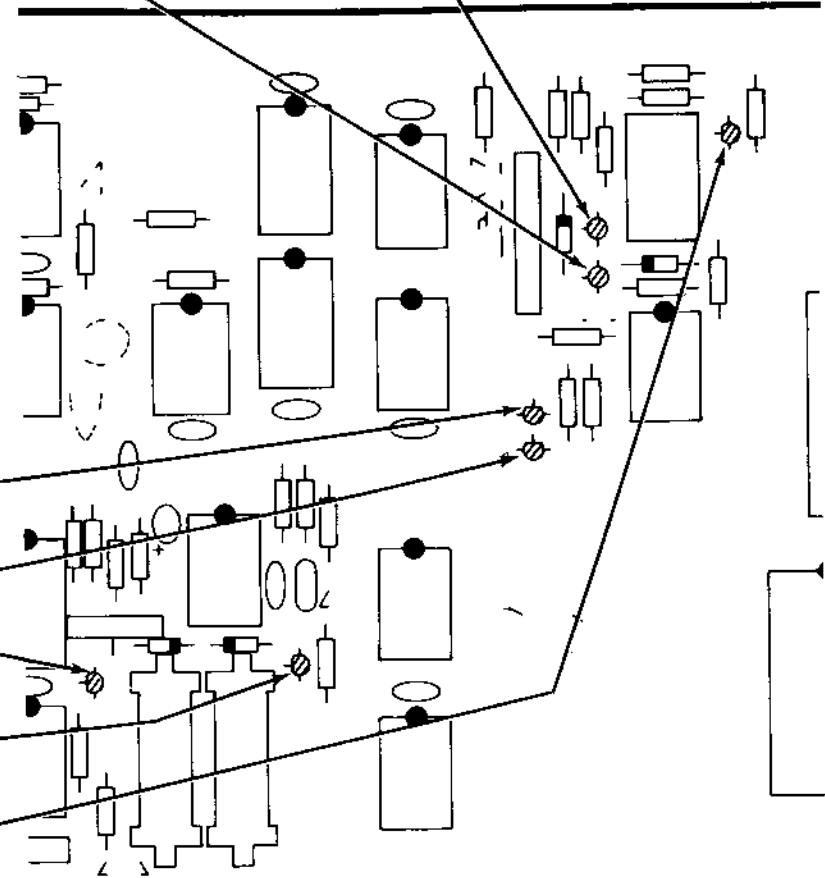

PICTORIAL 1-8

**START** ↘

**NOTE:** Before you install ceramic capacitors, use long-nose pliers to remove the excess insulation from the capacitor leads.



C104: .001  $\mu$ F ceramic.

C114: .01  $\mu$ F ceramic.

C101: .047  $\mu$ F Mylar.

**NOTE:** When you install tantalum capacitors, be sure to position the plus (+) or color dot marked lead in the plus marked hole in the circuit board.

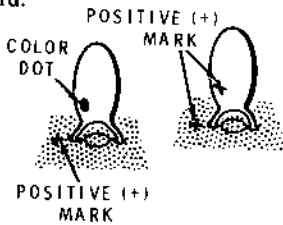

C102: 2.2  $\mu$ F tantalum.

C131: 2.2  $\mu$ F tantalum.

C115: .1  $\mu$ F ceramic.

C105: .1  $\mu$ F Mylar.

C111: 33  $\mu$ F tantalum.

Solder the leads to the foil and cut off the excess lead lengths.

IDENTIFICATION DRAWING

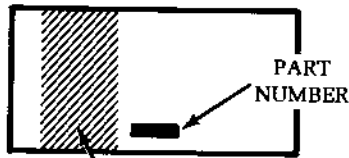

The steps performed in this Pictorial are in this area of the circuit board.

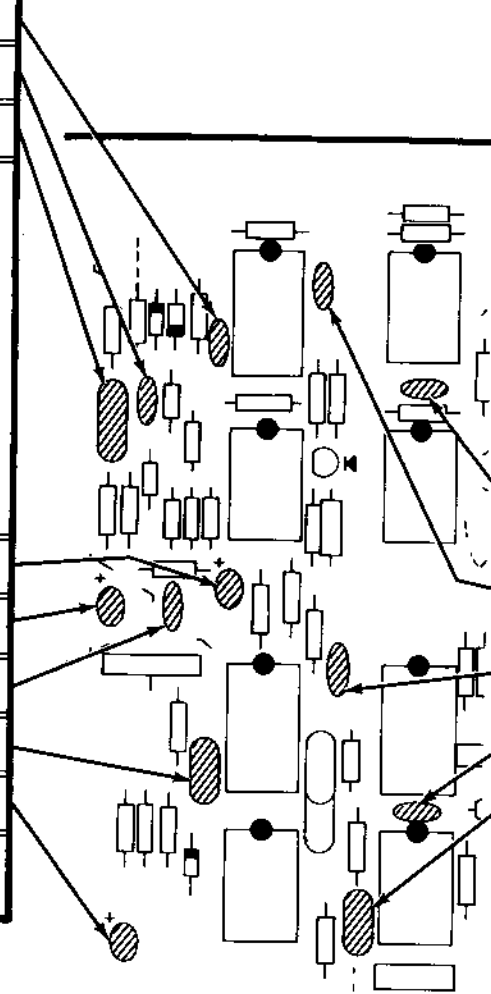

**CONTINUE** ↘

C117: .1  $\mu$ F ceramic.

C103: .001  $\mu$ F ceramic.

C106: .001  $\mu$ F ceramic.

C116: .1  $\mu$ F ceramic.

C108: .1  $\mu$ F Mylar.

Solder the leads to the foil and cut off the excess lead lengths.

PICTORIAL 1-9



IDENTIFICATION  
DRAWING

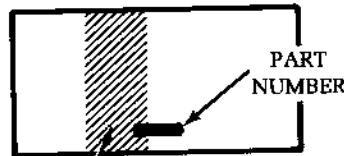

The steps performed in this Pictorial are in this area of the circuit board.

- START** →
- ( ) C121: .1  $\mu$ F ceramic.
  - ( ) C119: .1  $\mu$ F ceramic.
  - ( ) C124: .1  $\mu$ F ceramic.
  - ( ) C123: .1  $\mu$ F ceramic.
  - ( ) C122: .1  $\mu$ F ceramic.
  - ( ) C112: .005  $\mu$ F ceramic.
  - ( ) C109: 2.2  $\mu$ F tantalum.
  - ( ) C113: 27 pF ceramic.
  - ( ) C125: .1  $\mu$ F ceramic.
  - ( ) Solder the leads to the foil and cut off the excess lead lengths.
  - ( ) L101: 100  $\mu$ H coil. Solder its leads to the foil on the top side of the circuit board and cut off the excess lead lengths from the bottom side of the board.

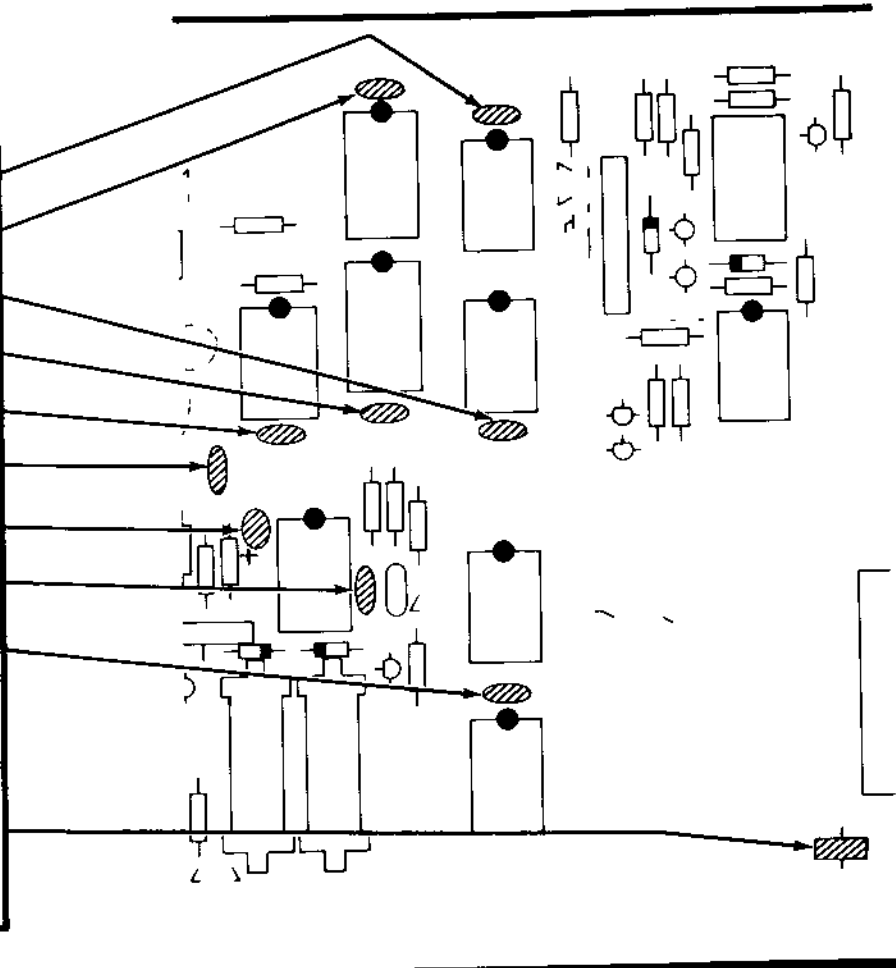

PICTORIAL 1-10

PART IDENTIFICATION NUMBER DRAWING



The steps performed in this Pictorial are in this area of the circuit board.

START

- ( ) C129: .1  $\mu$ F ceramic.
- ( ) SW101: Slide switch. Solder the lugs to the foil.
- ( ) C128: .1  $\mu$ F ceramic.
- ( ) C127: .1  $\mu$ F ceramic.
- ( ) Solder the leads to the foil and cut off the excess lead lengths.

NOTE: When you install a 25-pin connector:

- Refer to Detail 1-11A, part A, and position the socket on a hard flat surface with the pins along the surface as shown.
- Refer to part B of the Detail and roll the socket forward and bend the pins up approximately 15°.
- Refer to part C of the Detail and position the connector with its notches against the edge of the circuit board and the pins over the circuit board holes.
- Refer to part D of the Detail and roll the connector forward and insert the pins into the circuit board holes. Make sure the connector is tight against the board and then solder two pins at each end of the connector to the foils. Check the alignment and then solder the remaining pins to the foils.

- ( ) S101: Install two 25-pin connectors.

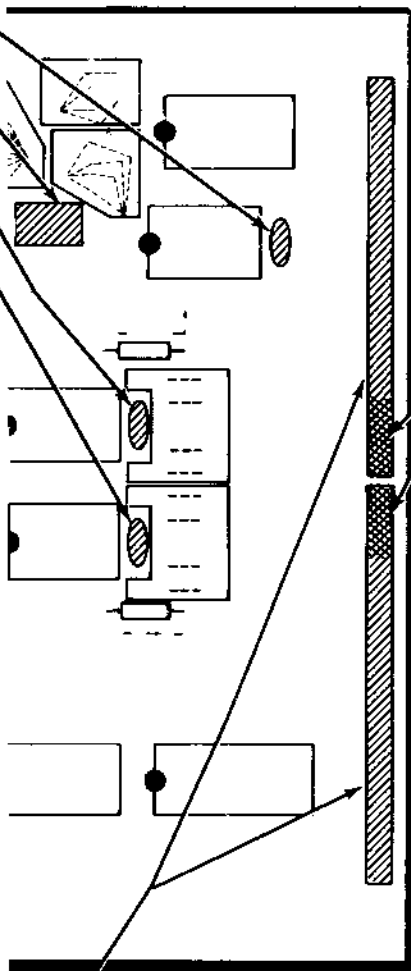

PICTORIAL 1-11

CONTINUE

- ( ) Install the connector key as follows:

- Cut two 1/2" x 1/4" lengths of tape, remove the protective covering from one side of each length, and apply the tape to the connectors at the locations shown.

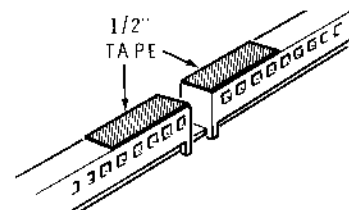

- Remove the other protective covering from the lengths of tape and press the connector key down onto the tape. Be sure the key is flush with the edge of the connector as shown.

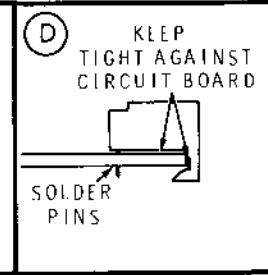
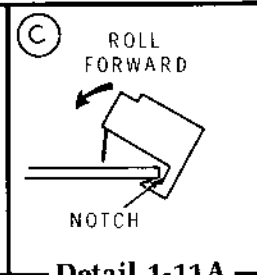
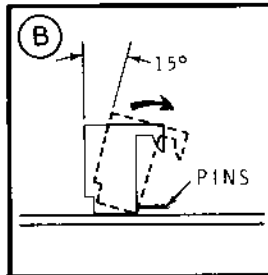
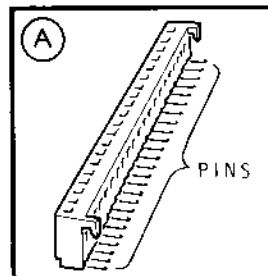
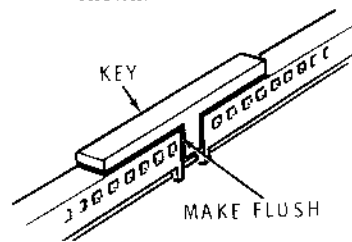

Detail 1-11A

**START**

NOTE: In the following steps, when you mount a phono socket, position it so its lug is away from the indicated circuit board edge as shown. Then solder the socket to the foil.

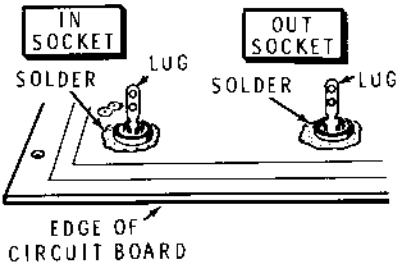

( ) Phono socket at OUT.

( ) Phono socket at IN.

( ) Bend each phono socket lug over so it is 1/4" above the foil. Be sure no part of this lug touches the socket body. Then solder a 3/8" bare wire between the IN phono socket lug and the circuit board foil as shown below. The correct foil is indicated by the white dotted line on the screened side of the circuit board. Use a cutoff component lead for the bare wire.

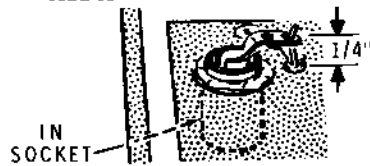

**NOTES:**

1. When you prepare jumper wires as in the following step, use the white solid wire. Cut it to the indicated lengths and remove 1/4" of insulation from each end.
2. When you connect a wire to the circuit board, as in the following step, solder it to the foil and cut off the excess wire length on the foil side.

( ) Prepare a 1" white solid wire.

( ) Remove an extra 1/4" (total 1/2") of insulation from one end of the wire. Insert the 1/2" bare end of the 1" white wire into the indicated circuit board hole. Pass this wire through the OUT phono socket lug and solder the wire to both the lug and the circuit board foil. You will connect the free end of this wire later.

**IDENTIFICATION DRAWING**

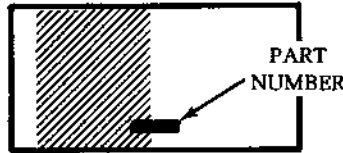

The steps performed in this Pictorial are in this area of the circuit board.

**CONTINUE**

( ) P101: 5-pin circuit board plug. Install it as shown and solder the pins to the foil.

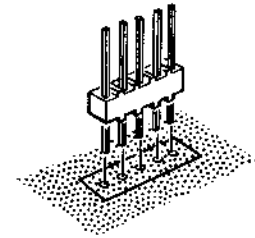

( ) P102: 10-pin circuit board plug.

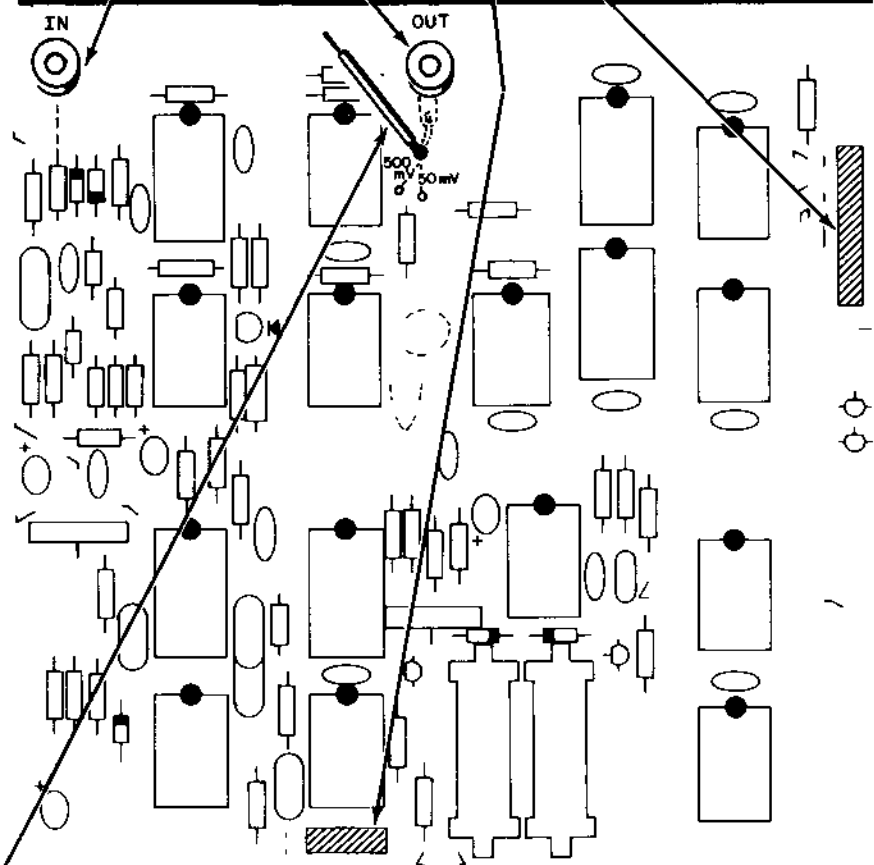

**PICTORIAL 1-12**

IDENTIFICATION  
DRAWING

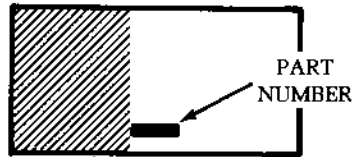

The steps performed in this Pictorial are in this area of the circuit board.

**START** →

( ) Y101: 4.00 MHz crystal (#404-536). Solder the leads to the foil and cut off the excess lead lengths.

**(A)**

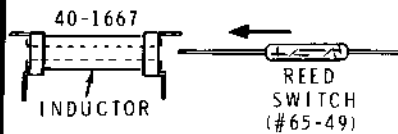

**(B)**

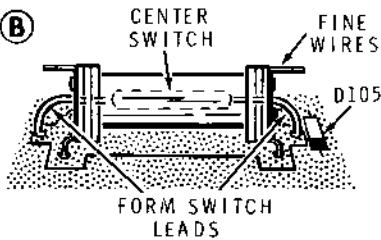

( ) RL101: Install a reed switch (#65-49) into an inductor body (#40-1667) as shown at A. Position the reed switch at the center of the inductor and form the leads as shown at B. (Be careful; the leads are fragile.) Position the inductor lugs with the fine wires wrapped around them towards diode D105 and insert the leads into the circuit board holes as shown. Solder the leads to the foil and cut off the excess lead lengths.

( ) RL102: Prepare a reed relay as above. Position the lugs with the fine wires wrapped around them towards diode D106. Solder the leads to the foil and cut off the excess lead lengths.

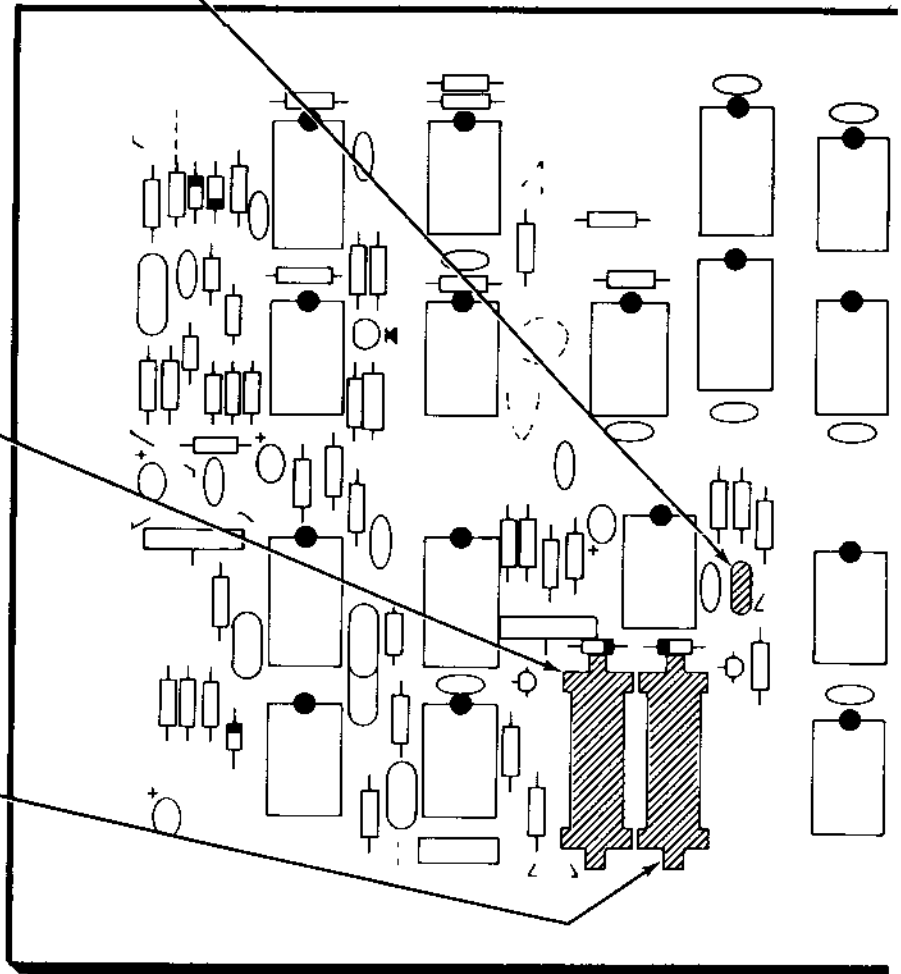

PICTORIAL 1-13

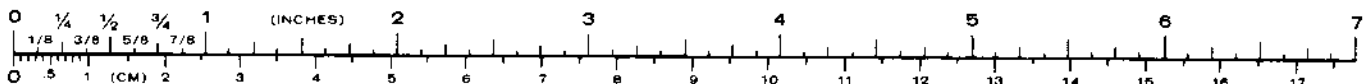

IDENTIFICATION  
DRAWING

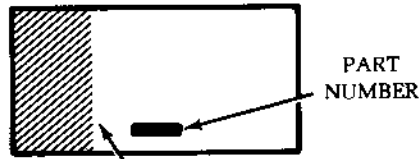

The steps performed in this Pictorial are in this area of the circuit board.

**START** →

( ) LED101:

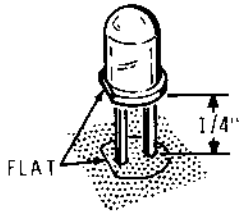

Position the LED so the flat is the same as the flat shown on the circuit board. Insert the leads into the circuit board holes. Position the bottom of the LED 1/4" above the circuit board. Solder the leads to the foil and cut off the excess lead lengths.

In the following steps, solder the control lugs to the foil as you install each one.

( ) R113: 5000  $\Omega$  (5k) control (#10-311).

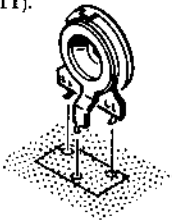

( ) R119: 200 k $\Omega$  control (#10-317).

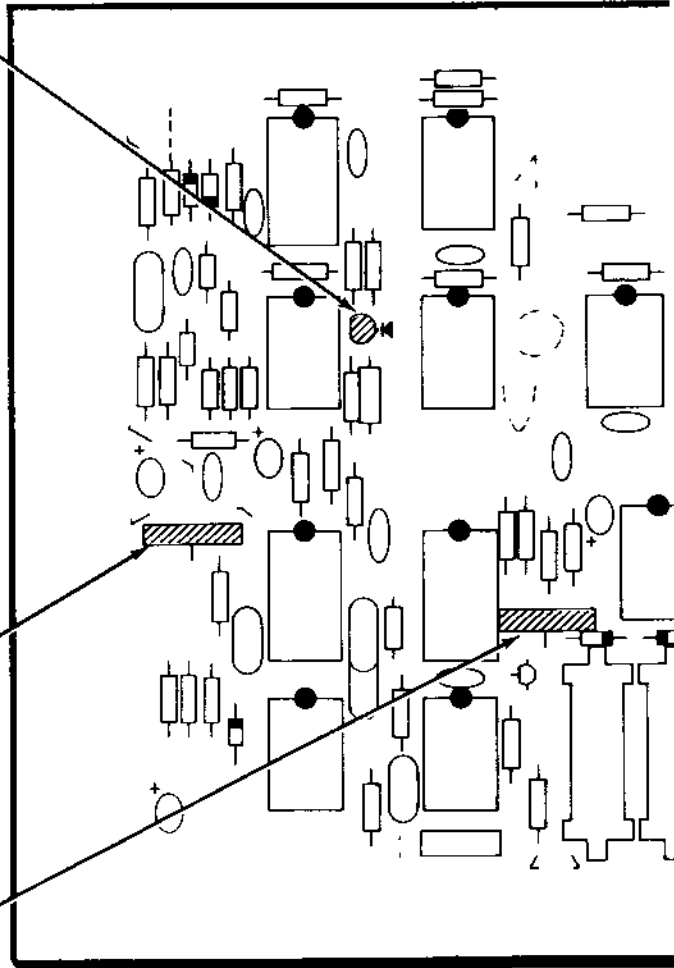

PICTORIAL 1-14



**START**

( ) Mount the bracket on the circuit board with two 6-32 x 1/4" screws, two #6 lockwashers, and two 6-32 nuts. Position it as shown.

( ) Refer to inset drawing #1 and open the silicone grease pod. Apply a liberal amount of grease to the bare metal side of the  $\mu$ A7805 integrated circuit (#442-54).

( ) IC133: Mount the  $\mu$ A7805 integrated circuit (#442-54) to the bracket with a 6-32 x 1/4" screw, #6 lockwasher, and a 6-32 nut. Face the bare metal side against the bracket. Position the leads as shown. The IC may be supplied in either of two case styles. (See inset drawing #2.)

( ) Cut the orange, white, and black stranded wires to 3". Remove 1/8" of insulation from one end of each wire and 1/4" of insulation from the other end.

( ) Install a spring connector on the 1/8" end of the prepared 3" white stranded wire.

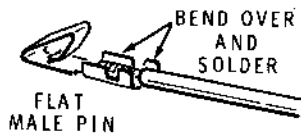

( ) Install a spring connector on the 1/8" end of the 3" orange and the 3" black stranded wires.

( ) Refer to Detail 1-15A and prepare the 3-hole connector shell.

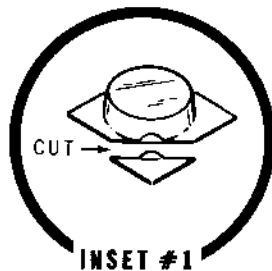

IDENTIFICATION DRAWING

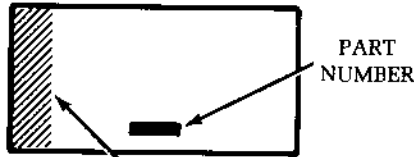

The steps performed in this Pictorial are in this area of the circuit board.

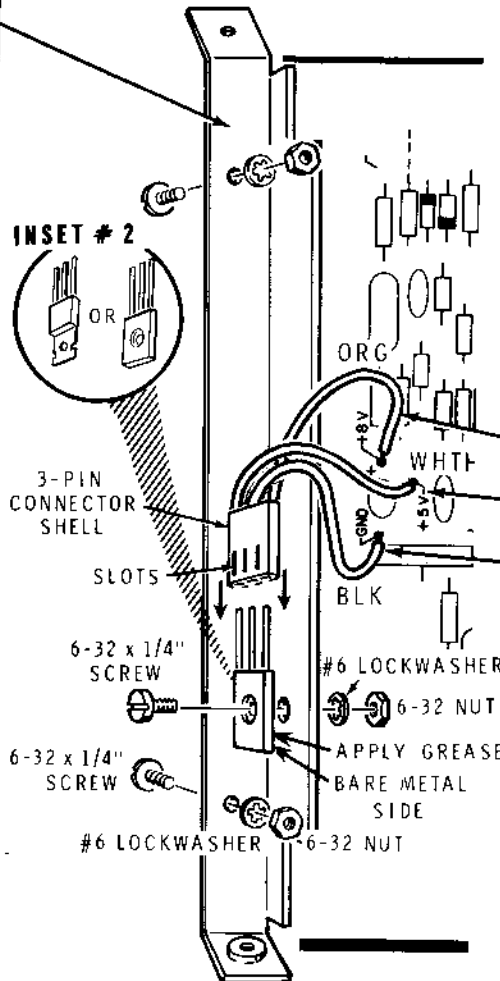

**CONTINUE**

Connect the three wires coming from the 3-hole connector shell to the circuit board as follows:

- ( ) Orange wire to hole +8V.
- ( ) White wire to hole +5V.
- ( ) Black wire to hole GND.

( ) Solder the wires to the circuit board foil and cut off the excess wire lengths.

( ) Push the 3-hole connector shell onto the integrated circuit leads as shown. Face the slots on the connector shell away from the bracket.

PICTORIAL 1-15

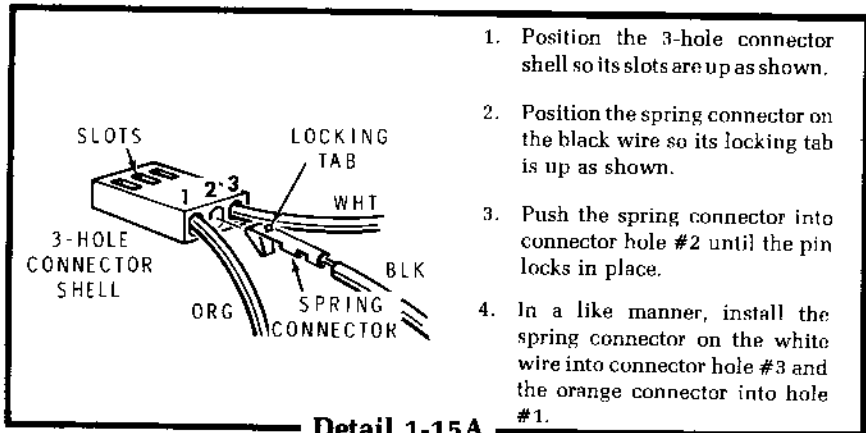

1. Position the 3-hole connector shell so its slots are up as shown.
2. Position the spring connector on the black wire so its locking tab is up as shown.
3. Push the spring connector into connector hole #2 until the pin locks in place.
4. In a like manner, install the spring connector on the white wire into connector hole #3 and the orange connector into hole #1.

Detail 1-15A

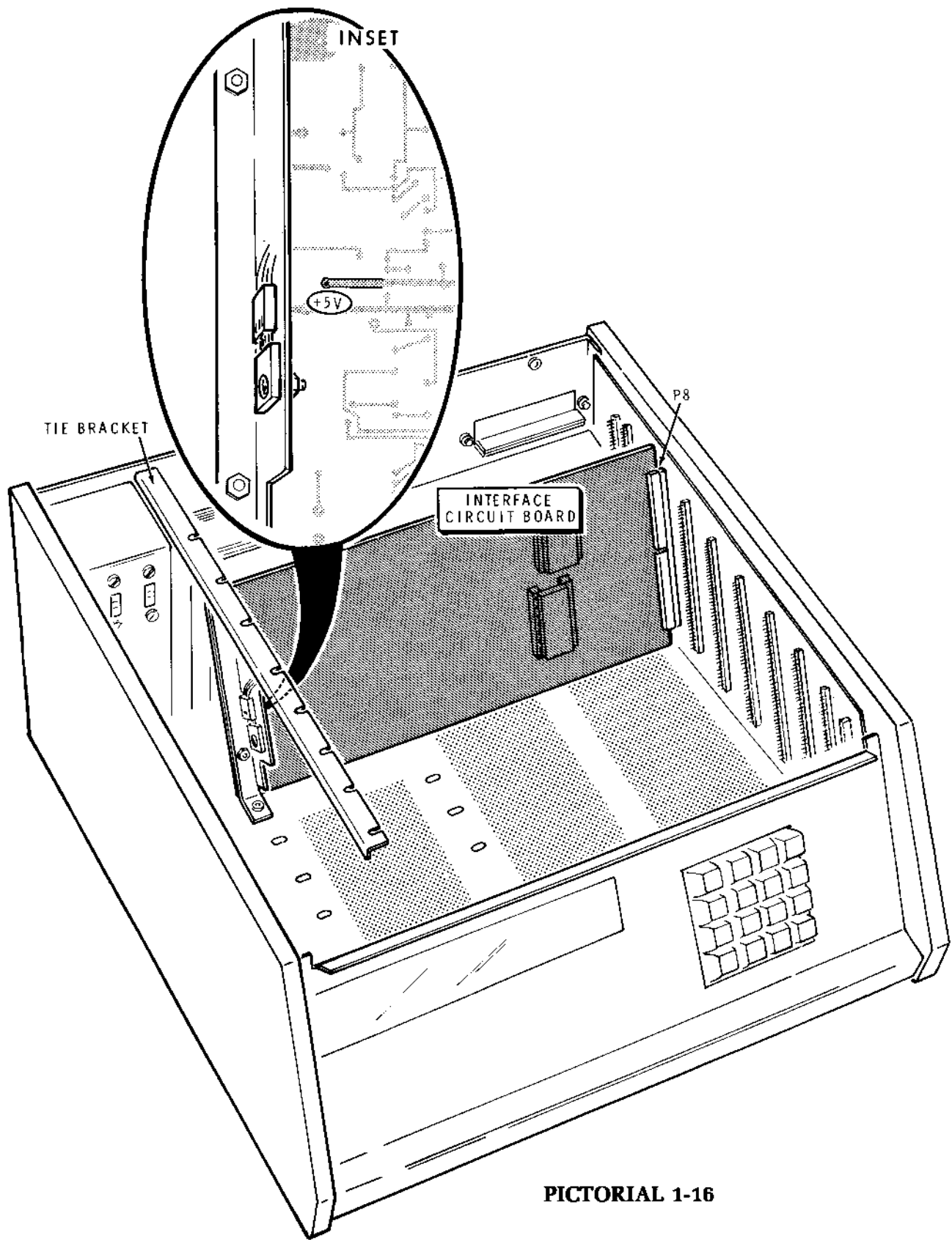

PICTORIAL 1-16

## CIRCUIT BOARD CHECKS

Refer to Pictorial 1-16 for the following steps.

- ( ) Make sure the POWER switch (on the rear panel of your Computer) is in the OFF position.
- ( ) Unplug the Computer's line cord.
- ( ) If not already done, remove the two screws that hold the top cover on the Computer. Then remove the cover.
- ( ) Remove the tie bracket from the Computer, if not already done.
- ( ) Position the interface circuit board inside the chassis assembly as shown. Then carefully push the two connectors at S101 on the edge of the circuit board onto the plugs at P8 on the mother circuit board.
- ( ) Plug the line cord into the proper AC outlet.

NOTE: If you do not obtain the proper results in the following steps, push the POWER switch to OFF and refer to the "Possible Cause" chart which follows each check.

- ( ) Push the POWER switch to ON. The PWR LED, RUN LED, ION LED and MON LED on the front panel should light.

PROBLEM	POSSIBLE CAUSE
PWR LED and RUN LED do not light.	A. Fuse. B. Solder bridge on interface circuit board. C. IC133.

NOTE The following checks require a VTVM or VOM. If you do not have one available, remove the interface circuit board from the Computer and carefully inspect the circuit board for solder bridges. Then proceed to "Integrated Circuit Installation."

- ( ) Connect the common lead of your meter to the chassis.
- ( ) Set your meter to measure +5 volts DC.
- ( ) Touch the probe of your VTVM to the indicated foil at +5V (white wire). The meter should indicate approximately 5 volts (4.75 to 5.25 volts).

PROBLEM	POSSIBLE CAUSE
Meter does not indicate 5 volts.	A. Solder bridge on interface circuit board. B. Wiring error on interface circuit board at IC133. C. IC133.

- ( ) Push the POWER switch to OFF and unplug the line cord.
- ( ) Disconnect the VTVM from the chassis and interface circuit board.
- ( ) Remove the interface circuit board from the computer.



**ASSEMBLY CONTINUED**

**START**

( ) Position the circuit board as shown.

In the following steps, install IC's (integrated circuits) in the designated sockets. Be careful to match the pin 1 end of each IC to the index mark on the circuit board. See Detail 1-16A (above).

Before you apply downward pressure to an IC, make sure each IC pin is centered in its proper socket hole. Handle IC's with care, as their pins bend very easily.

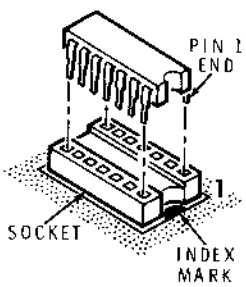

**CAUTION:** The first three integrated circuits that you will install are MOS devices that can be damaged by static electricity. Use the following sequence when you install IC106, IC124, and IC123.

1. Remove the IC mounted in conductive foam from its envelope.
2. Hold the IC in one hand and pull the conductive foam pad from the pins.
3. Pick up the circuit board while you hold the IC.
4. Carefully insert the IC in its socket before you set the circuit board down onto your work surface. The IC is now protected by the socket and foil.

( ) IC106: CD4046AE (#442-647).

( ) IC124: 8251 (#443-776).

( ) IC123: 8251 (#443-776).

( ) IC125: SN7442N (#443-53).

( ) IC129: SN7403N (#443-54).

( ) IC128: SN7403N (#443-54).

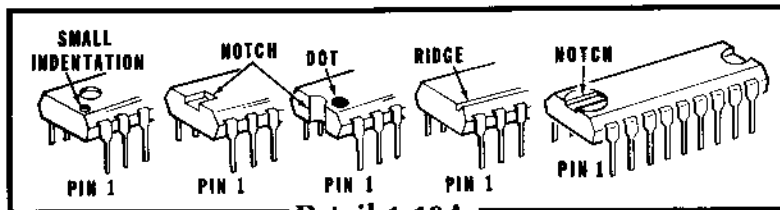

**Detail 1-16A**

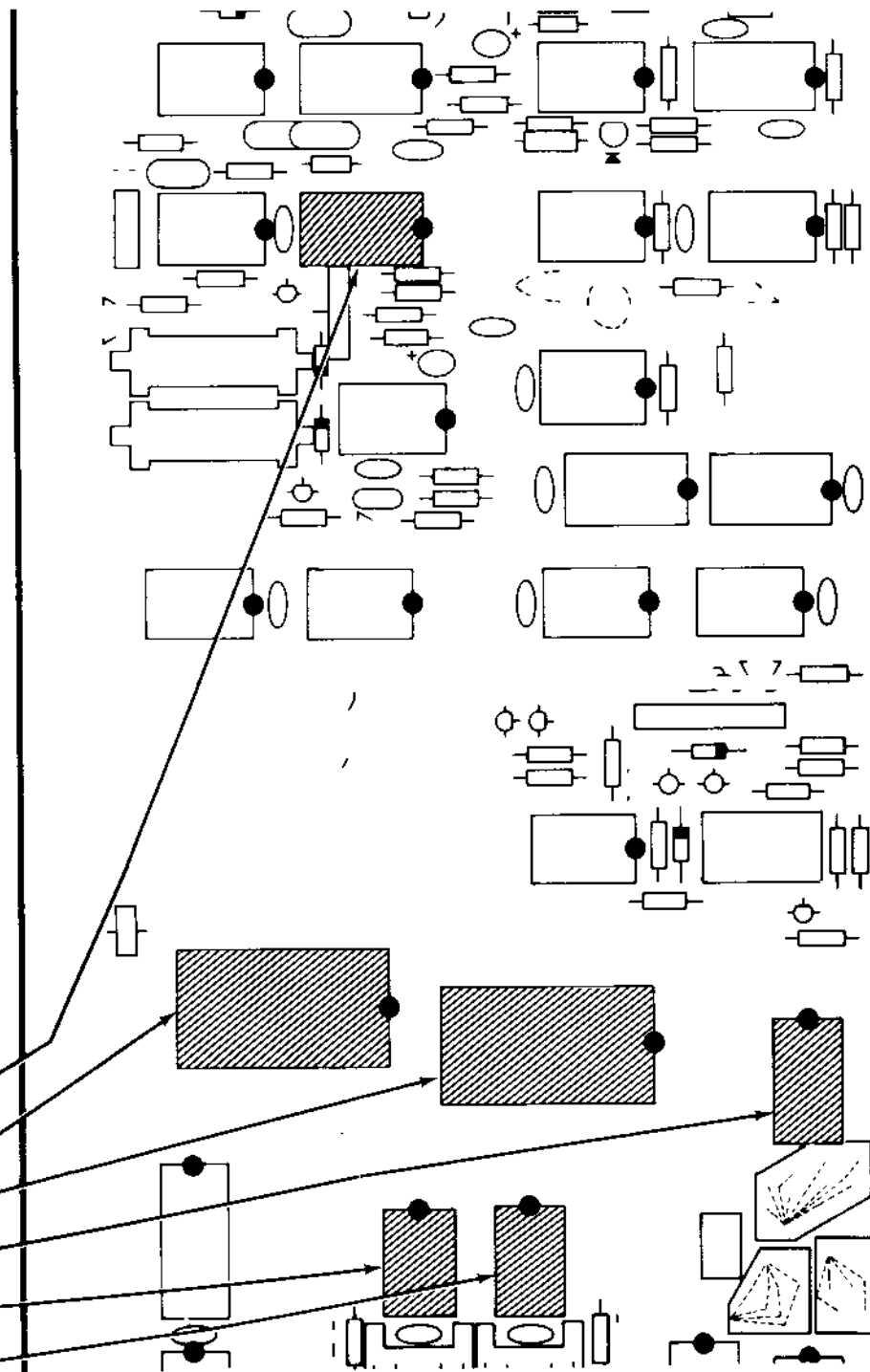

**PICTORIAL 1-17**

**START** 

- IC101: SN74123N (#443-90).
- IC102: LM3302N, LM2901, or  $\mu$ A775 (#442-616).
- IC103: SN74123N (#443-90).
- IC104: SN74LS74N (#443-730).
- IC108: SN74LS00N (#443-728).
- IC107: SN7493N (#443-640).
- IC105: SN74LS74N (#443-730).
- IC111: SN74LS73N (#443-828).
- IC112: SN7404N (#443-18).  
NOTE: DO NOT install SN74LS04N (#443-755) here.
- Install an SN74LS161N (#443-757) at each of the following IC locations:
- IC113.....
- IC114.....
- Install an SN7493AN (#443-640) at each of the following IC locations:
- IC115.....
- IC116.....

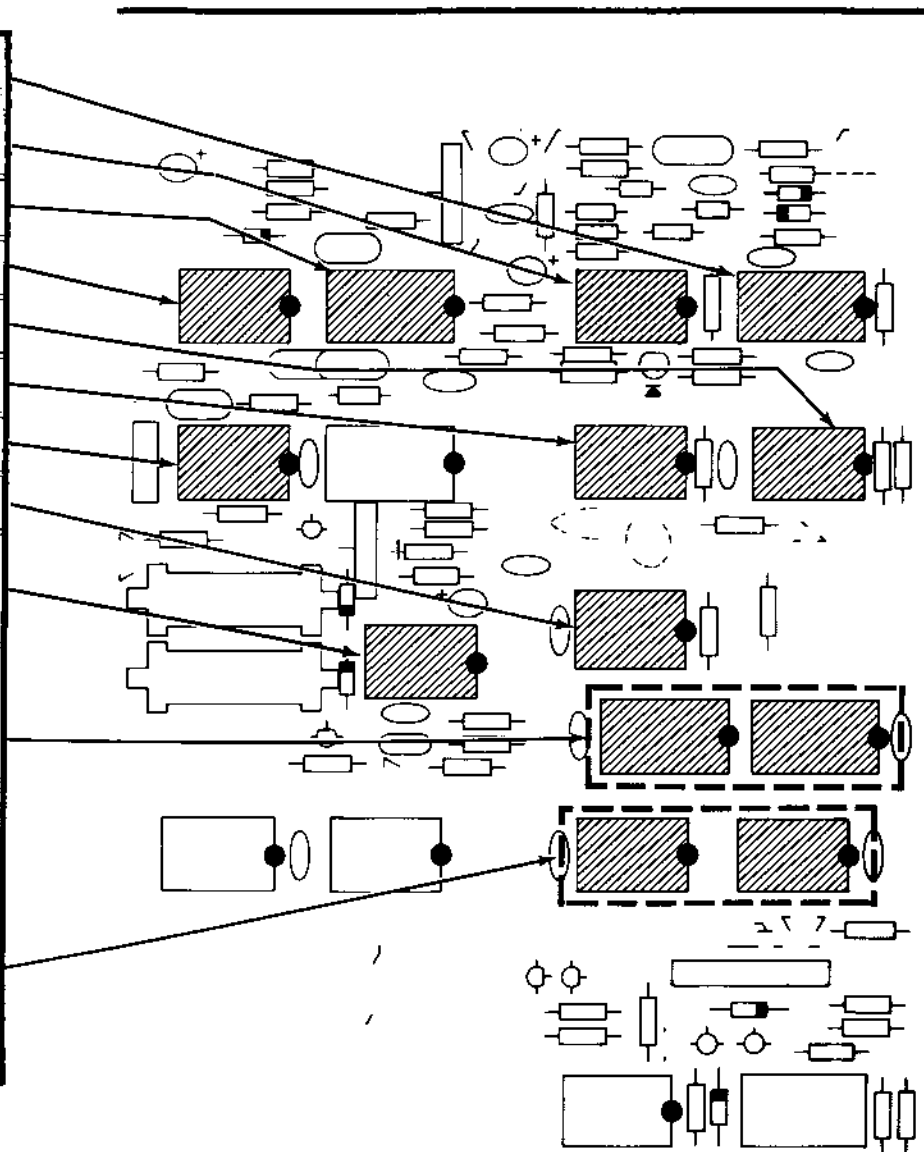

PICTORIAL 1-18

**START**

( ) IC117: SN7408N (#443-45).

( ) IC118: SN74LS00N (#443-728).

**NOTE:** When you install the following two integrated circuits, they will both plug into the same socket. Make sure you position pin 1 on both IC's correctly. Notice that they face opposite directions.

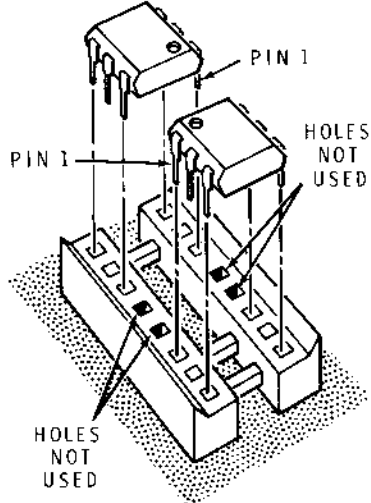

( ) IC119, IC121: 4N26 (#443-808).

( ) IC122: SN74LS00N (#443-728).

( ) IC126: 74LS139 (#443-822).

( ) IC127: SN7414N (#443-858).

( ) IC131: SN74LS240N (#443-754).

( ) IC132: SN74LS240N (#443-754).

( ) Check each integrated circuit to make sure that the pin 1 end is nearest the index mark on the circuit board.

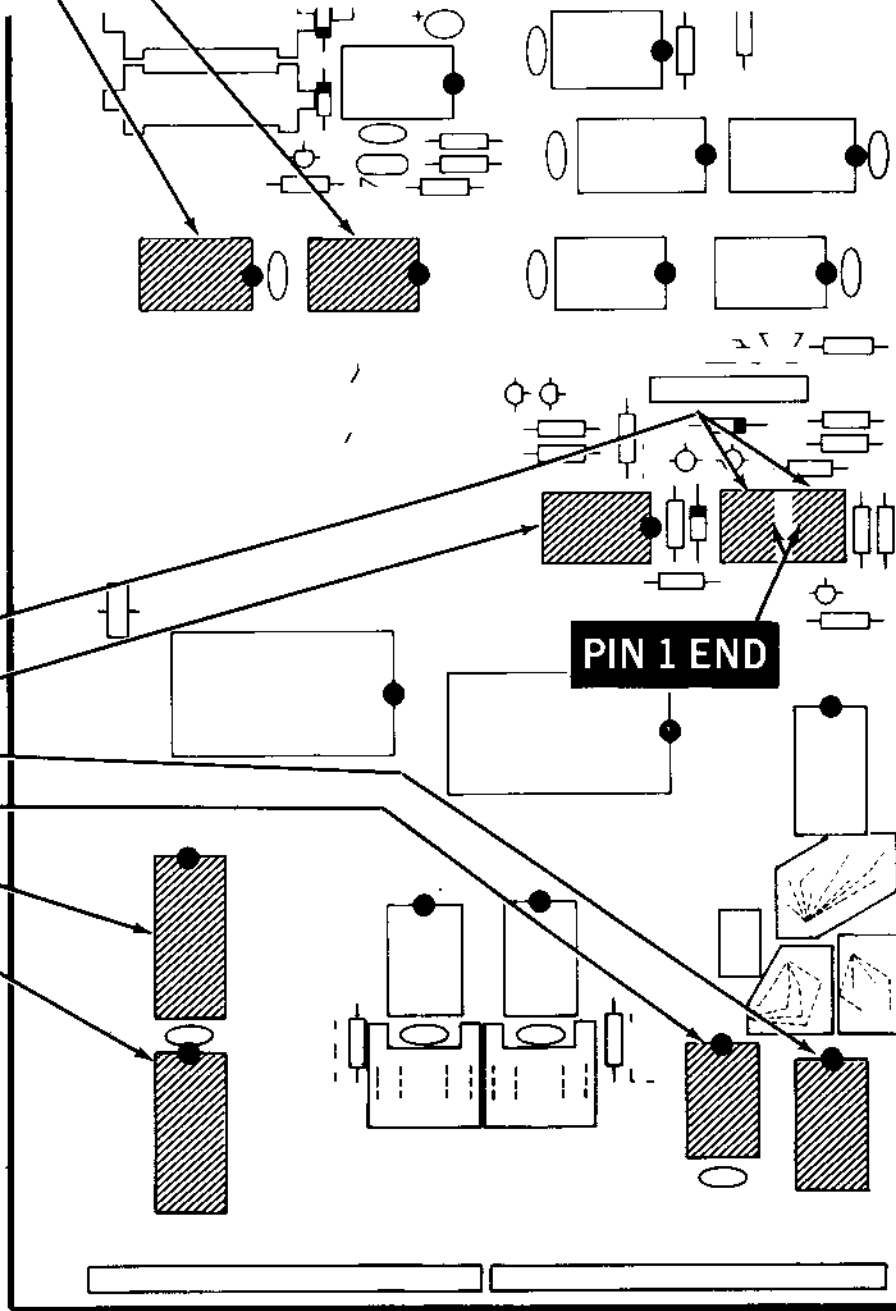

**PICTORIAL 1-19**

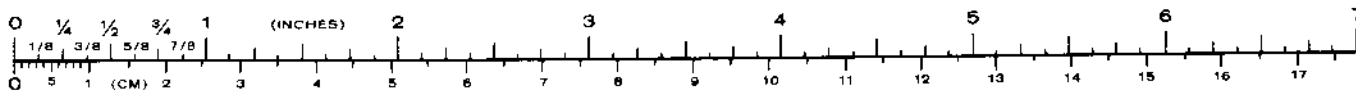

IDENTIFICATION  
DRAWING

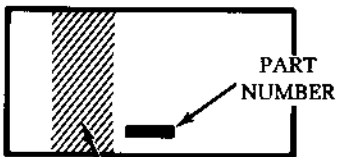

The steps performed in this Pictorial are in this area of the circuit board.

JUMPER OPTIONS

START

Position the circuit board as shown and perform the following steps. Solder each jumper wire as you install it.

500 mV or 50 mV

The following jumper wire selects the proper audio output level to your tape recorder.

- ( ) If you use the AUX or LINE inputs on your tape recorder, connect the free end of the jumper wire to the 500 mV circuit board hole. If you use the MIC input on your tape recorder, connect the free end of the jumper wire to the 50 mV circuit board hole. The Heath-recommended ECP-3801 cassette recorder uses the 30 mV input.

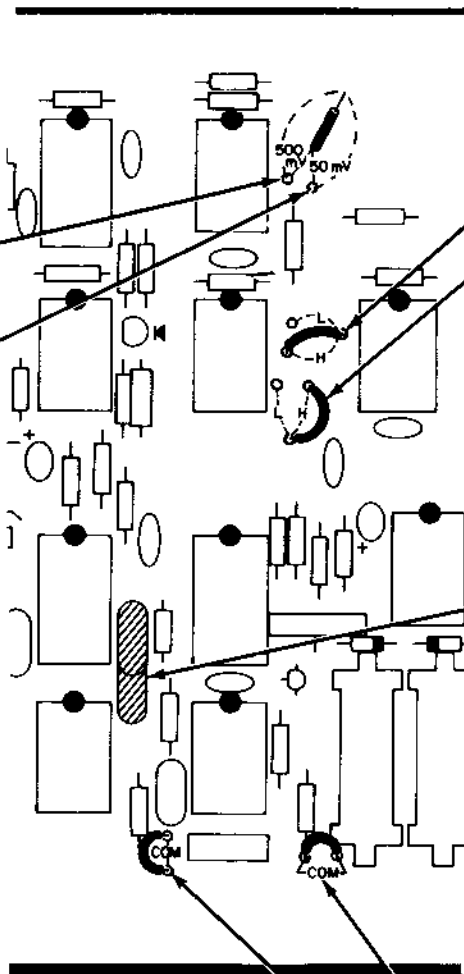

CONTINUE

Tape RX Baud Rate

NOTE: The following two jumpers and capacitor, and the "Tape TX Baud Rate" jumper on Pictorial 2-2, select the operating speed of the tape interface; either 300 baud or 1200 baud. Since Heath software tapes were recorded at 1200 baud, you will wire your interface to operate at 1200 baud. If, in the future, you want the interface to operate at 300 baud, make the necessary changes as instructed. (Do not forget the jumper on Pictorial 2-2.)

- ( ) Prepare two 1" wires.

In the next two steps you will install the wires at "H" for 1200 baud operation. Later, if you want your interface to operate at 300 baud, move the wires to "L."

- ( ) 1" jumper wire at H.

- ( ) 1" jumper wire at H.

NOTE: In the next step you will install a 230 pF capacitor for 1200 baud operation. Later, if you want your interface to operate at 300 baud, install a 1000 pF (.001) polystyrene capacitor here.

- ( ) C107: 230 pF mica. Solder the leads to the foil and cut off the excess lead lengths. (Use the holes that fit your capacitor.)



COM (Common)

The following steps will allow you to pick one tape recorder to playback (LOAD) or record (STORE) data. If you intend to use two tape recorders to simultaneously playback and record, disregard the following steps and proceed to Pictorial 2-2.

- ( ) Prepare two 1" wires.

- ( ) 1" jumper wire.

- ( ) 1" jumper wire.

PICTORIAL 2-1

**START** →

**EIA or TTY**

In the following steps, you will select the type of signals (EIA, 20 mA active, or 20 mA passive current loop) for use with your terminal. Refer to the "Operation" section of this Manual and determine which type of signal you want to use and perform **only** that section as described below. If you intend to use the Heath H9 terminal, perform the steps under EIA. If you use the H36 DEC Writer, perform the steps under 20 mA Active Current Loop.

IDENTIFICATION  
DRAWING



The steps performed in this Pictorial are in this area of the circuit board.

**CONTINUE** →

**Tape Tx Baud Rate**

You will install the next wire from TAPE TX to 1200 — for 1200 baud operation. Later, if you want your interface to operate at 300 baud, move the wire to "300."

- ( ) Prepare a 1-1/2" wire.
- ( ) Connect the 1-1/2" jumper wire from hole TAPE TX to hole 1200.

**EIA RS-232**

- ( ) Prepare three 1" wires.
- ( ) 1" wire .....
- ( ) 1" wire .....
- ( ) 1" wire .....

**20 mA ACTIVE CURRENT LOOP**

- ( ) R152: 680 Ω, 1/2-watt, 5% (blue-gray-brown) at R152.
- ( ) Prepare three 1" wires.
- ( ) 1" wire .....
- ( ) 1" wire .....
- ( ) 1" wire .....

**20 mA PASSIVE CURRENT LOOP**

- ( ) R152: 680 Ω, 1/2-watt, 5% (blue-gray-brown) at R152.
- ( ) Prepare a 1" white wire.
- ( ) 1" wire .....

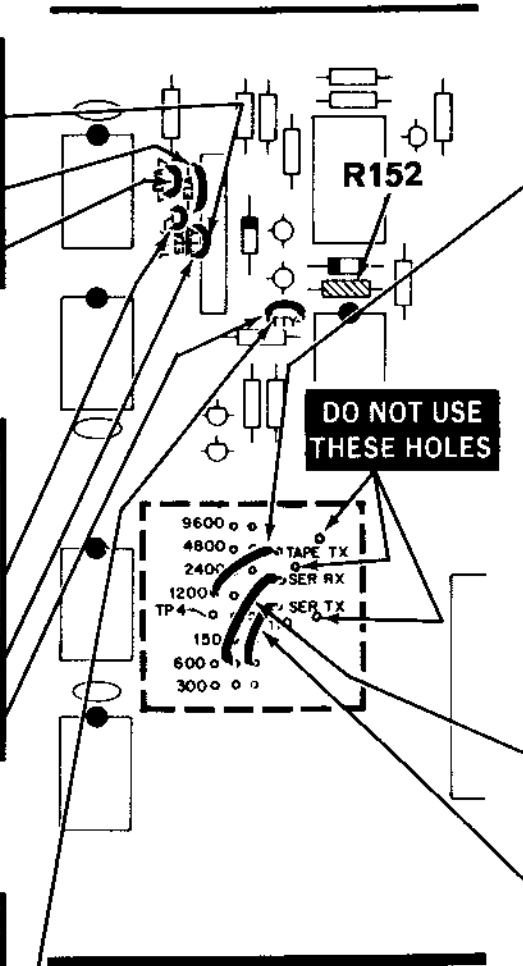

**Serial Rx Tx Baud Rates**

In the following steps you will install wires from SER RX and SER TX to holes that match the baud rate of your terminal. Some common speeds are:

- Teletype — 110.
- H36 (High speed mechanical) 300.
- Heath H9 — 600.

- ( ) Prepare and install a jumper wire from hole SER RX to a hole that matches the speed of your terminal.
- ( ) Prepare and install a jumper wire from hole SER TX to a hole that matches the speed of your terminal.

**PICTORIAL 2-2**

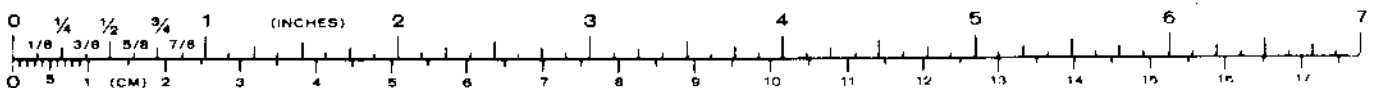

**START**

**Port Select**

The following jumper wires assign port numbers to the two USARTs. These are the parts used by the Heath software and are as follows:

1. Load/Dump port at 370 and 371;
- AND
2. Console port at 372 and 373.

( ) Prepare four 1" white wires.

Connect each of the 1" wires to the circuit board as follows:

- ( ) 1" jumper from circuit board hole T to hole 3.
- ( ) 1" jumper from circuit board hole W to hole 7.
- ( ) 1" jumper from circuit board hole X to hole 2.
- ( ) 1" jumper from circuit board hole Y to hole 0.

**Interrupt Select**

( ) Prepare three 1" white wires.

Install the three wires as follows:

- ( ) 1" jumper at indicated RXR holes. (Do not use the RXR holes directly above.)
- ( ) 1" jumper from hole S to hole 13.
- ( ) 1" jumper at indicated INT ON holes.

**NOTE:** The remaining holes are not used with the Heath H8 Computer.

IDENTIFICATION  
DRAWING

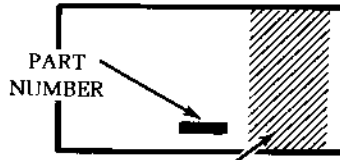

The steps performed in this Pictorial are in this area of the circuit board.

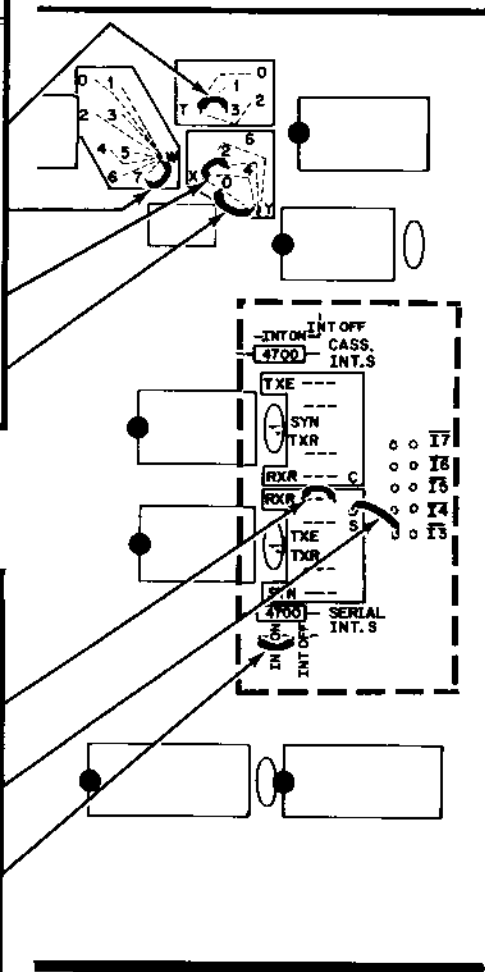

**CONTINUE**

**CIRCUIT BOARD CHECKOUT**

Carefully inspect the circuit board for the following conditions.

- ( ) Unsoldered connections.
- ( ) Poor solder connections.
- ( ) Solder bridges between foils.
- ( ) Protruding leads which could touch together.
- ( ) Transistors for the proper type and installation.
- ( ) Electrolytic capacitors for the correct position of the positive (+) end.
- ( ) Diodes for the correct position of the banded end.

Set the circuit board aside.

This completes the "Circuit Board Step-by-Step Assembly." Proceed to "Cable Assembly."

**FINISH**

PICTORIAL 2-3

### CABLE ASSEMBLY

Refer to Pictorial 3-1 (Illustration Booklet, Page 2) for the following steps.

- ( ) Cut a 2-foot length of flat 8-wire cable.
- ( ) Refer to Detail 3-1A and prepare end A of the flat 8-wire cable as shown. Use diagonal cutters or a knife to start separating the wires.

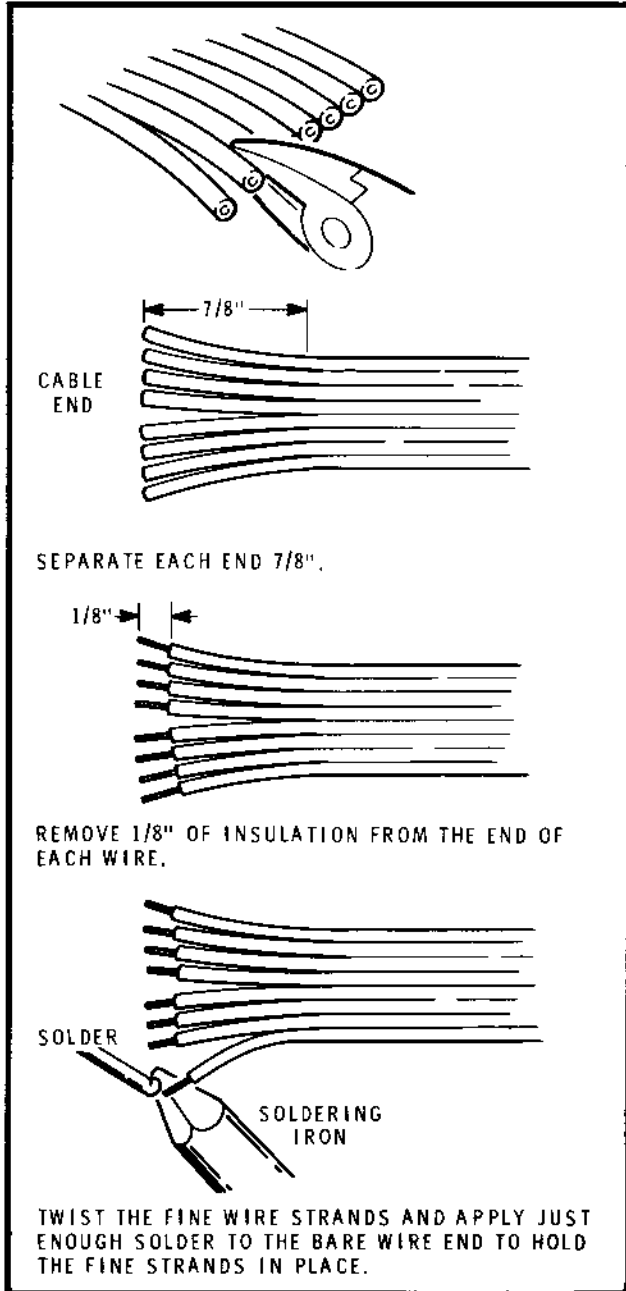

**Detail 3-1A**

- ( ) Refer to Detail 3-1B and crimp and solder a female pin (#432-855) on the end of each prepared wire. Remove 1/2 of each indicated tab on the female pin before you crimp it to the wire.

**NOTE:** Insert the female pins on the end of the following wires into the 15-hole male connector shell with ears as follows. Note that the hole numbers are stamped in the back of the connector. Each time you install a pin, gently pull on the wire to make sure the wire is locked in place.

- ( ) Brown wire in hole 3.
- ( ) Red wire in hole 4.
- ( ) Orange wire in hole 5.
- ( ) Yellow wire in hole 6.
- ( ) Green wire in hole 7.
- ( ) Blue wire in hole 8.
- ( ) Violet wire in hole 9.
- ( ) Gray wire in hole 10.
- ( ) Refer to Part 1 of Detail 3-1C and cut end B of the flat 8-wire cable as shown.
- ( ) Refer to Part 2 of Detail 3-1C, separate each wire end 1", remove 1/4" of insulation from the wire ends, apply a small amount of solder to the bare ends, and then cut the bare ends to 1/8".
- ( ) Refer to Detail 3-1D and crimp and solder a spring connector (#432-866) on the end of each prepared wire. Refer to the inset drawing and form the wire ends with the flat male pins as shown.

**NOTE:** Insert the spring connector on the ends of the following wires into the 10-hole connector shell as follows. Note that the number 1 is stamped in the top of the connector. Each time you install a connector pin, gently pull on the wire to make sure the wire is locked in place.

- ( ) Brown wire in hole 3.
- ( ) Red wire in hole 4.
- ( ) Orange wire in hole 5.

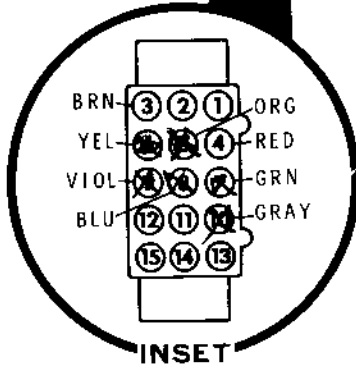
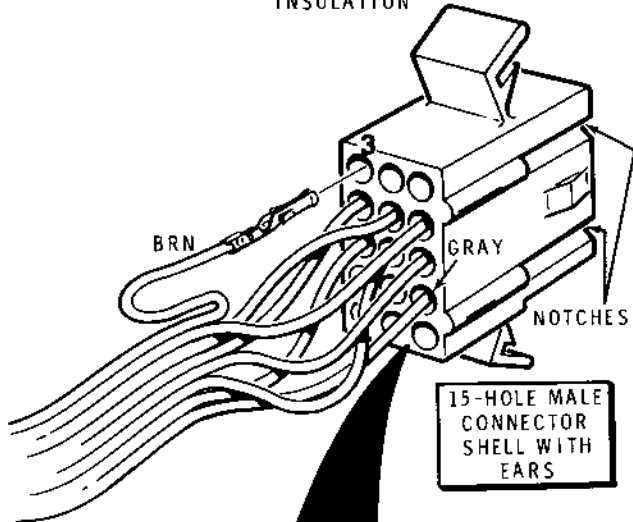
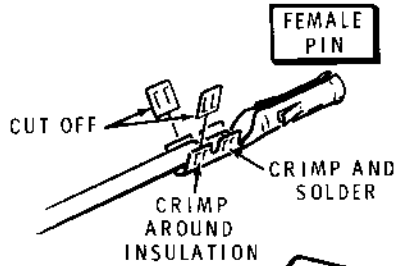

Detail 3-1B

- ( ) Yellow wire in hole 6.
- ( ) Green wire in hole 7.
- ( ) Blue wire in hole 8.
- ( ) Violet wire in hole 9.
- ( ) Gray wire in hole 10.

Set the cable aside.

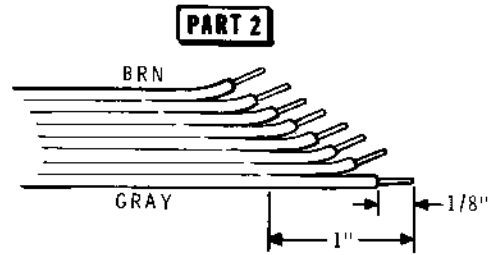
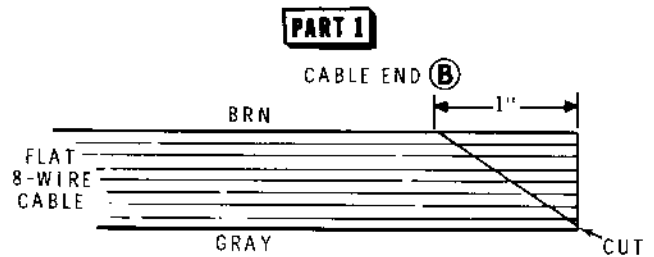

Detail 3-1C

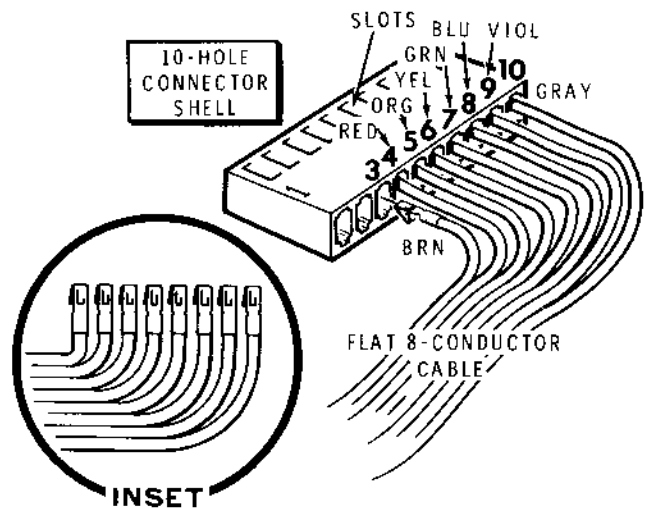
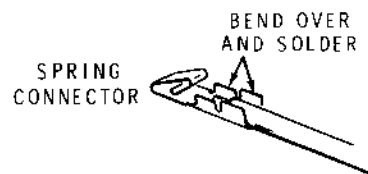

Detail 3-1D

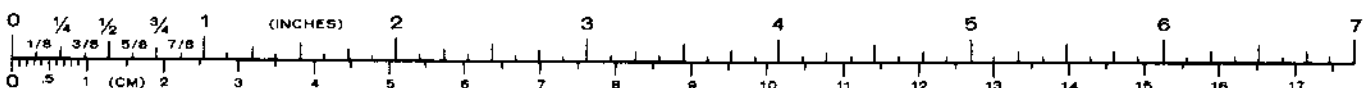



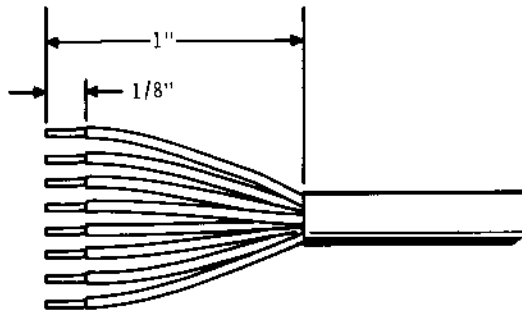

**Detail 3-2A**

NOTE: If you have purchased the H36 DEC Writer II, proceed directly to "Wiring for DEC Writer II" on Page 33. If you did not purchase a DEC Writer II, continue with the following steps.

Refer to Pictorial 3-2 (Illustration Booklet, Page 2) for the following steps.

- ( ) Cut a 4-foot length of round 8-wire cable.
- ( ) Refer to Detail 3-2A and prepare one end of the round 8-wire cable as shown. When you remove the outer insulation, be careful not to cut the insulation on the inner wires.
- ( ) Refer to Detail 3-2B and crimp and solder a round male pin (#432-854) on the end of each prepared wire. Remove 1/2 of each indicated tab on the male pin before you crimp it to a wire.

NOTE: Insert the round male pins on the end of the following wires into the 15-hole female connector shell with ears as follows. Note that the hole numbers are stamped in the back of the connector. Each time you install a pin, gently pull on the wire to make sure it is locked in place.

- ( ) Orange wire in hole 3.
- ( ) Brown wire in hole 4.
- ( ) White wire in hole 5.
- ( ) Yellow wire in hole 6.
- ( ) Blue wire in hole 7.
- ( ) Red wire in hole 8.
- ( ) Green wire in hole 9.
- ( ) Black wire in hole 10.

### Connections for H9 Terminal

NOTE: If you intend to use the serial I/O board with the Heath H9 terminal, perform the following steps. If you do not intend to use the H9 terminal, refer to the "Operation" section of this Manual for information concerning other types of terminal connections.

- ( ) Locate the following parts left over from your H9 terminal:
  1. One 9-hole female connector shell (#432-183, may not have ears).
  2. Three round female pins (#432-855).
- ( ) Remove a 3/4" length of outer insulation from end B of the round 8-wire cable. When you remove the outer insulation, be careful not to cut the insulation on the inner wires.
- ( ) Cut off all except the brown, red, and white wires from the 8-wire cable. Remove 1/8" of insulation from the three wire ends.
- ( ) Refer to Detail 3-2C and crimp and solder a female pin on the end of each prepared wire. Remove 1/2 of each indicated tab on the male pin before you crimp it to a wire.

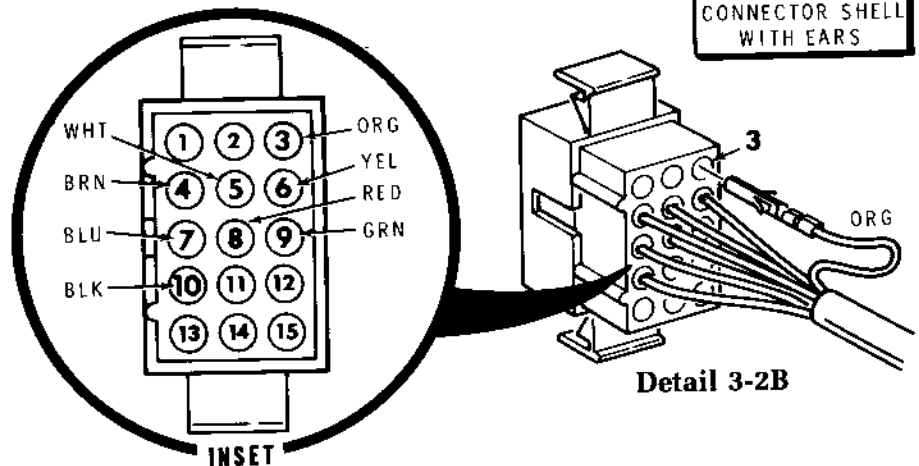
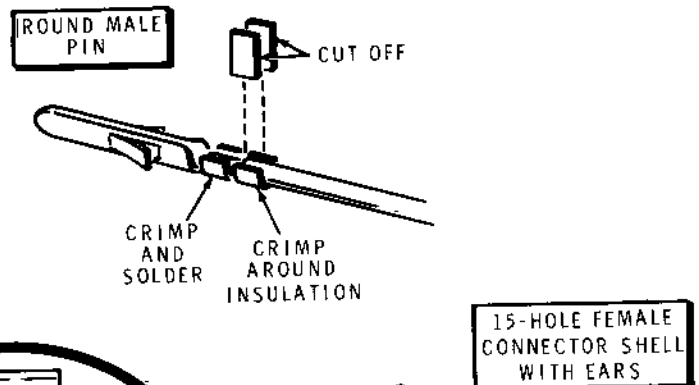

**Detail 3-2B**

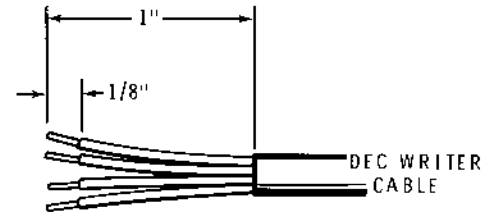
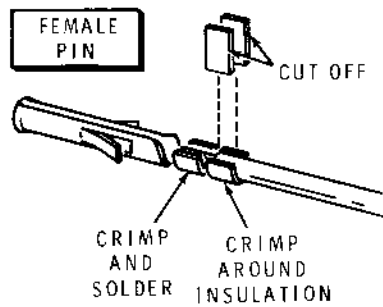

Detail 3-2D

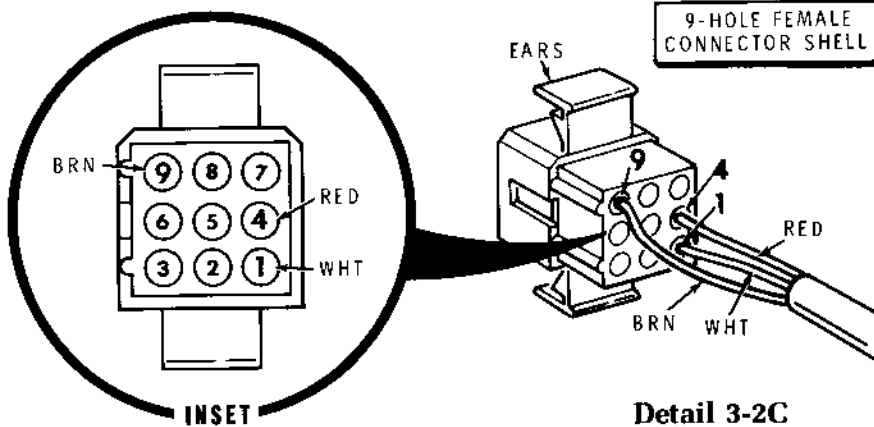

Detail 3-2C

NOTE: Insert the female pins on the end of the following wires into the 9-hole female connector shell with ears as follows. Note that the hole numbers are stamped in the back of the connector as shown in the inset drawing of Detail 3-2C. Each time you install a pin, gently pull on the wire to make sure it is locked in place.

- ( ) White wire in hole 1.
- ( ) Red wire in hole 4.
- ( ) Brown wire in hole 9.

Set the cable aside.

Proceed to "2-Wire Cables" on Page 34.

### Wiring For DEC Writer II

- ( ) Cut the end off the DEC Writer cable 3" from the end.

- ( ) Refer to Detail 3-2D and prepare the cable end as shown.
- ( ) Refer to Detail 3-2E (Illustration Booklet, Page 2) and crimp and solder a round male pin (#432-854) on the end of each prepared wire. Remove 1/2 of each indicated tab on the male pin before you crimp it to a wire.

NOTE: Insert the round male pins on the end of the following wires into the 15-hole female connector shell with ears as follows. Note that the hole numbers are stamped in the back of the connector. Each time you install a pin, gently pull on the wire to make sure it is locked in place.

- ( ) Black wire to hole 10.
- ( ) Green wire to hole 9.
- ( ) Red wire to hole 8.
- ( ) White wire to hole 5.



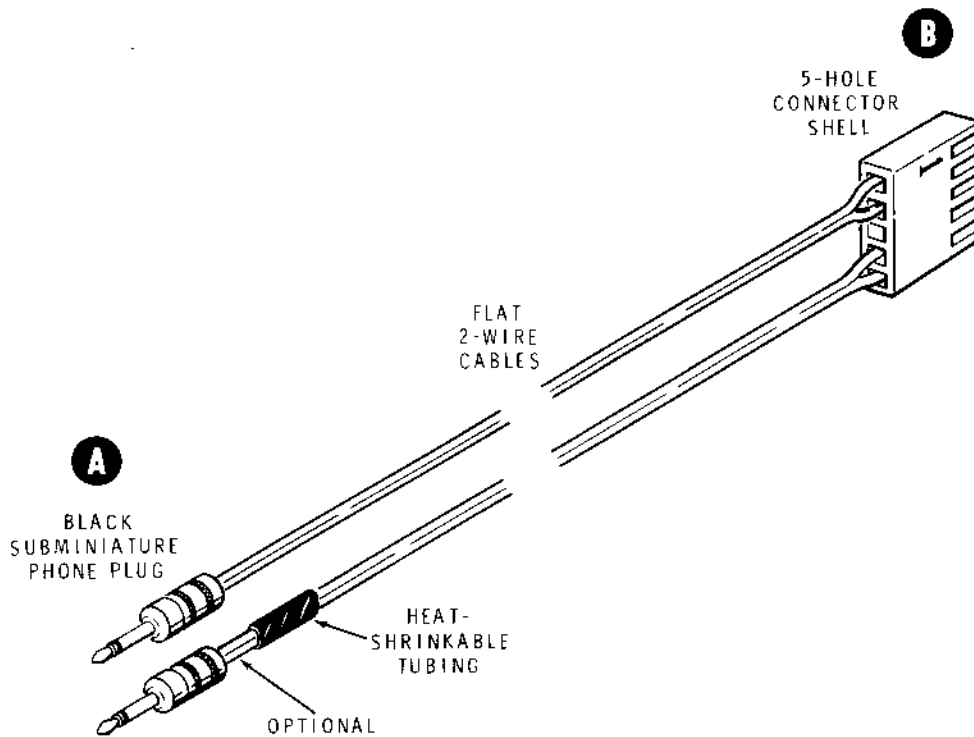

**PICTORIAL 3-3**

**2-Wire Cables**

Refer to Pictorial 3-3 for the following steps.

**NOTE:** In the following steps you will assemble two 2-wire cables. Complete the first cable; then repeat the steps where indicated by double check spaces for the second cable. Some steps use only one check space. Perform these steps only once as instructed.

( ) ( ) Cut a 4-foot length of 2-wire cable.

( ) ( ) Refer to Detail 3-3A and prepare ends A and B of the 2-wire cable as shown.

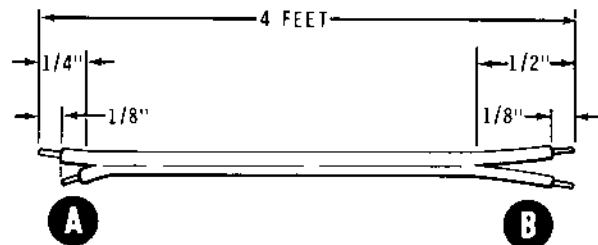

**Detail 3-3A**



## END A

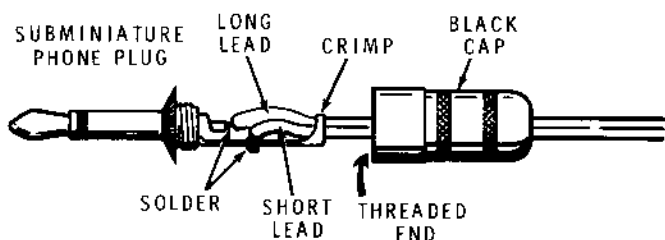

Detail 3-3B

- ( ) ( ) Refer to Detail 3-3B for the next three steps. Remove the black cap from the subminiature phone plug. Slide the cap over the 2-wire cable with the threaded end as shown.
- ( ) ( ) Solder the long and short wires at end A of the 2-wire cable to the indicated lugs on the subminiature phone plug. NOTE: You may find it easier to clamp the phone plug in a small vice to hold it steady while you solder the wires to it.
- ( ) ( ) After the connections cool, crimp the indicated lugs around the 2-wire cable as shown. Replace the black cap on the phone plug.
- ( ) ( ) Refer to Detail 3-3C and crimp and solder a spring connector on the end of each prepared wire at end B of the 2-wire cable.
- ( ) Repeat the previous steps and assemble the second 2-wire cable.

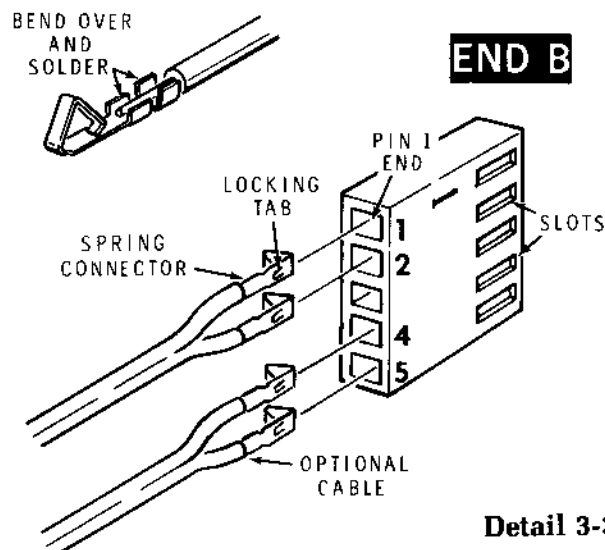

Detail 3-3C

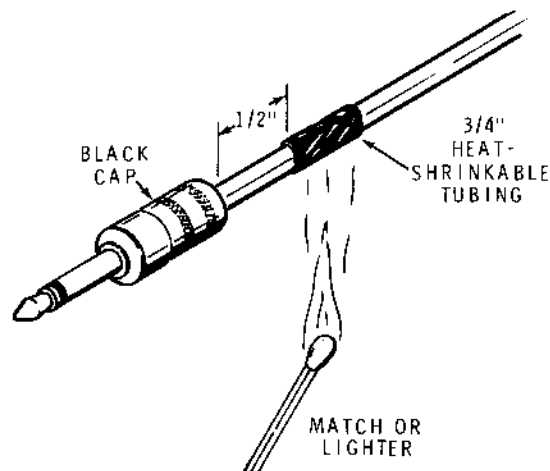

Detail 3-3D

- ( ) Position the 5-hole connector shell with the pin 1 end as shown. The slots should face up.
- ( ) Position the spring connector on the ends of the wires of the 2-wire cable so the locking tabs are up as shown. Push the connectors into connector holes 1 and 2. Pull gently on the wires to make sure they are locked in place.
- ( ) Refer to Detail 3-3D and cut a 3/4" piece of heat-shrinkable tubing. Slide the tubing over end B of the second 2-wire cable and position it approximately 1/2" from the subminiature phone plug. Shrink the tubing in place with a lighter or a match. Be careful not to melt the cable insulation.

NOTE: The second cable you prepared is optional. If you do not intend to use two tape recorders (one for recording and one for playing back), set this optional 2-wire cable aside and proceed directly to Page 36. If you do intend to use two tape recorders, proceed to the next step.

- ( ) Position the spring connector on the ends of the wires of the 2-wire cable so the locking tabs are up as shown. Push the connectors into connector holes 4 and 5. Gently pull on the wires to make sure they are locked in place.

Set the cable assembly aside.

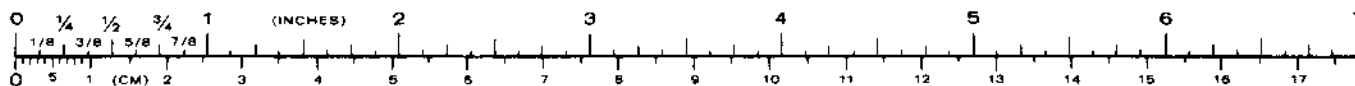

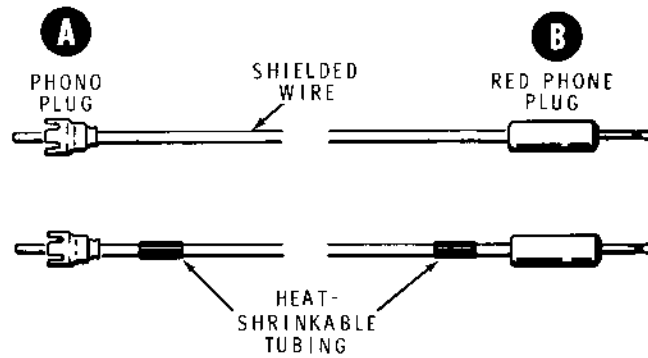

PICTORIAL 3-4

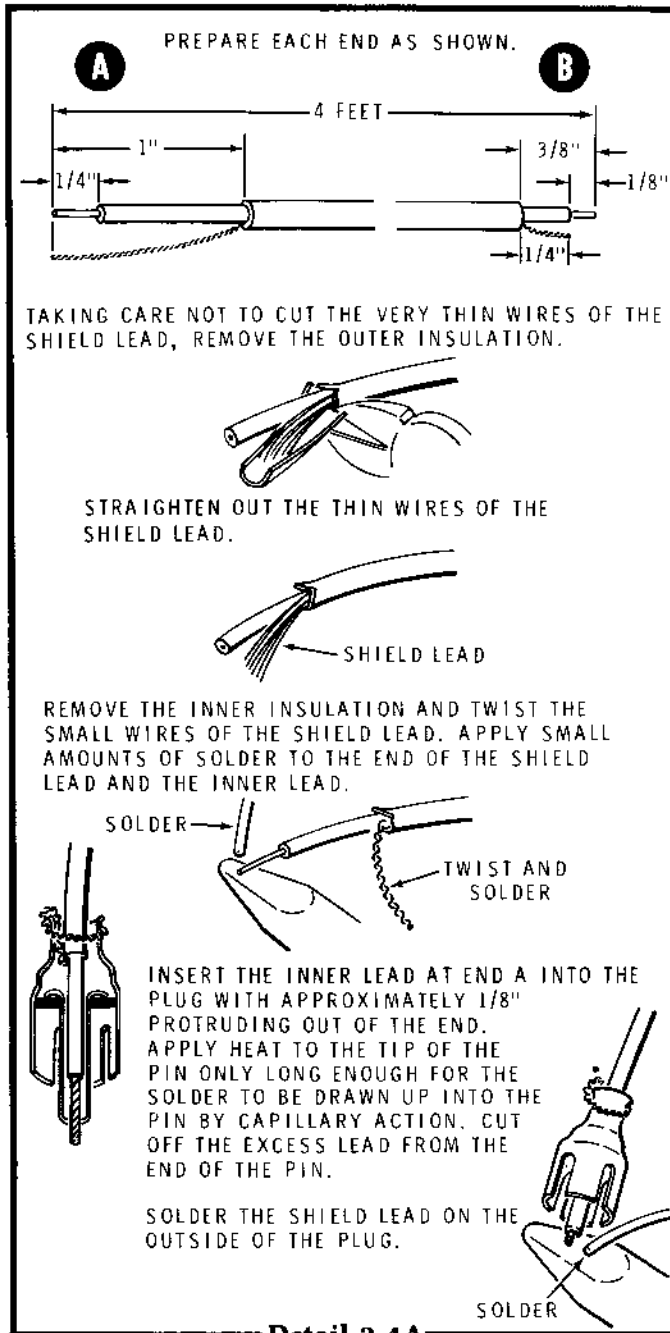

Refer to Pictorial 3-4 for the following steps.

**NOTE:** In the following steps, you will be instructed to assemble two shielded wire cables. After you complete the first cable, repeat the steps for the second cable where double check spaces are provided. Some steps have only one check space. Perform these steps only once as instructed.

- ( ) ( ) Refer to Detail 3-4A and prepare a shielded wire and phono plug as shown.
- ( ) Cut two 3/4" pieces of heat-shrinkable tubing and slide them over end B on one shielded wire.
- ( ) ( ) Remove the red cap on one of the phone plugs and slide it over the shielded wire at end B with the threaded end as shown.
- ( ) ( ) Refer to Detail 3-4B and solder the center lead of the shielded wire to the indicated lug of the phone plug. Solder the shield to the indicated location on the phone plug. After the connection cools, replace the red cap on the phone plug.

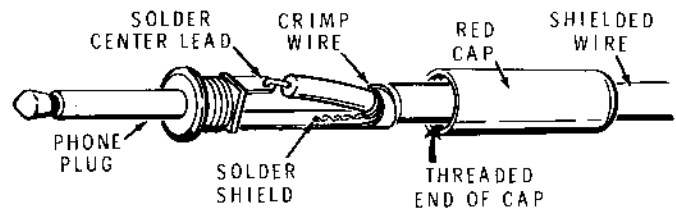

Detail 3-4B

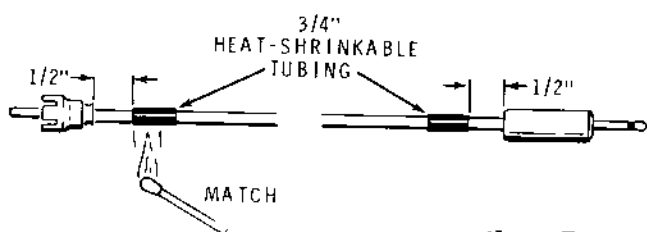
**Detail 3-4C**

- ( ) Refer to Detail 3-4C and position the previously installed 3/4" pieces of heat-shrinkable tubing approximately 1/2" from each plug on the shielded wire. Shrink the tubing in place with a lighter or a match.
- ( ) If an ohmmeter is available, make continuity checks of your cables.

This completes the "Cable Assembly." Set the two cables aside.

### CABLE CONNECTIONS

Refer to Pictorial 3-5 (Illustration Booklet, Page 2) for the following steps.

NOTE: Install the cable assemblies on the circuit board as follows. Make sure you position the pin 1 end on each connector over the pin 1 end of the circuit board plugs.

- ( ) 5-hole connector to P101.

- ( ) 10-hole connector S102 to P102.
- ( ) Phono plug P104 (with the heat-shrinkable tubing) to IN.
- ( ) Phono plug P105 to OUT.

NOTE: You will connect the free end of the cables during the "Installation and Adjustments."

Set the circuit board aside.

Refer to Pictorial 3-6 for the following step.

- ( ) Locate the blue and white label and remove the protective paper backing. Then press the label onto the rear panel of your H8 Computer as shown. Refer to the numbers on this label in any correspondence you may have with the Heath Company concerning this kit.

Proceed to "Installation and Adjustments."

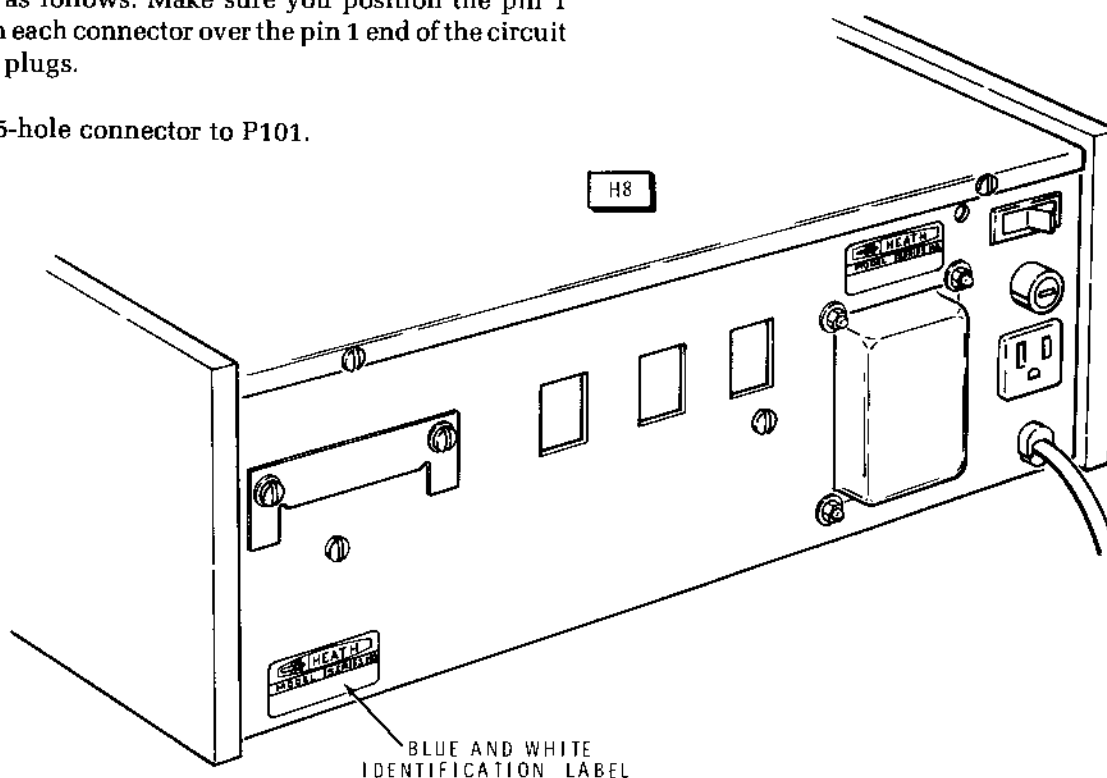
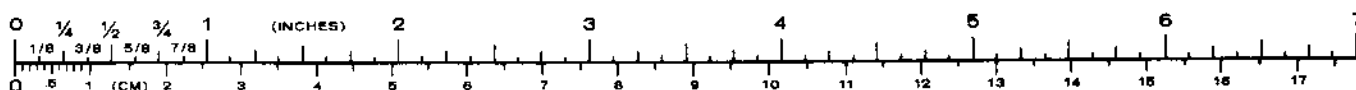
**PICTORIAL 3-6**

## INSTALLATION AND ADJUSTMENTS

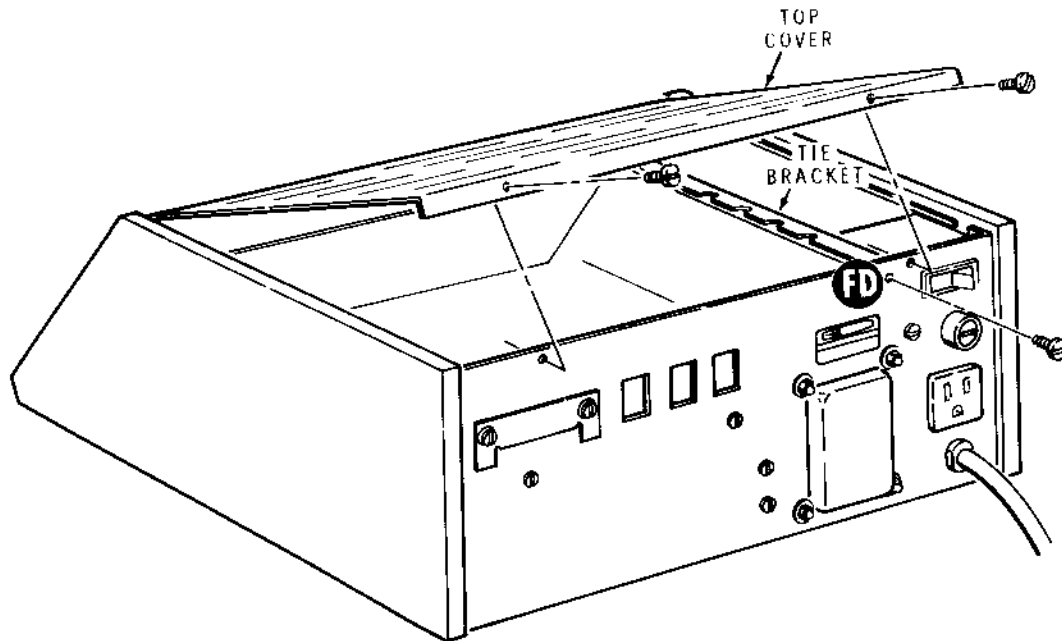

PICTORIAL 4-1

Refer to Pictorial 4-1 for the following steps.

- ( ) Be sure your Computer is turned off.
- ( ) Remove the two rear panel screws holding the top cover and set the top cover aside if not already done.
- ( ) Remove rear panel screw FD. Then loosen the other screws in the tie bracket, remove the bracket, and set it aside.

Refer to Pictorial 4-2 for the following steps.

**NOTE:** In the next step, you will install the Card into the Computer. Install the Card in one of the unused plugs near the rear of the Computer, but do not try to install it at P10. It will not fit.

- ( ) Plug the Serial I/O and Cassette Interface Card onto the selected plug in your Computer.

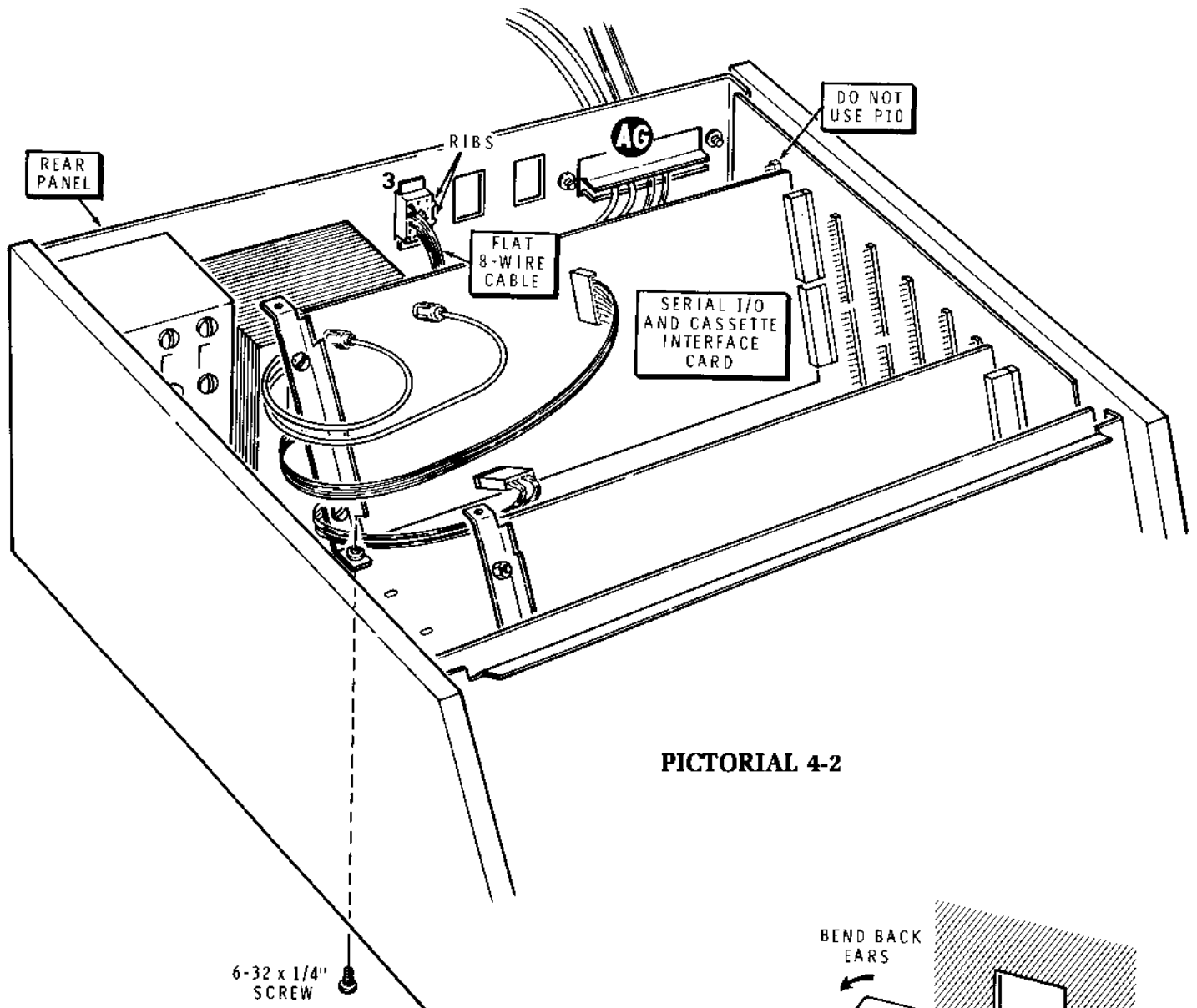

PICTORIAL 4-2

- ( ) Refer to Detail 4-2A, bend back the two tabs, and insert the connector on the flat 8-wire cable into rear panel hole 3. Be sure the connector ribs are positioned as shown.
- ( ) Loosen the two screws of cable clamp AG, open the clamp, route the remaining cables through the clamp, and then close the clamp on the cables and retighten the screws.
- ( ) Install a 6-32 × 1/4" screw through the bottom of the computer chassis to hold the Card in place.

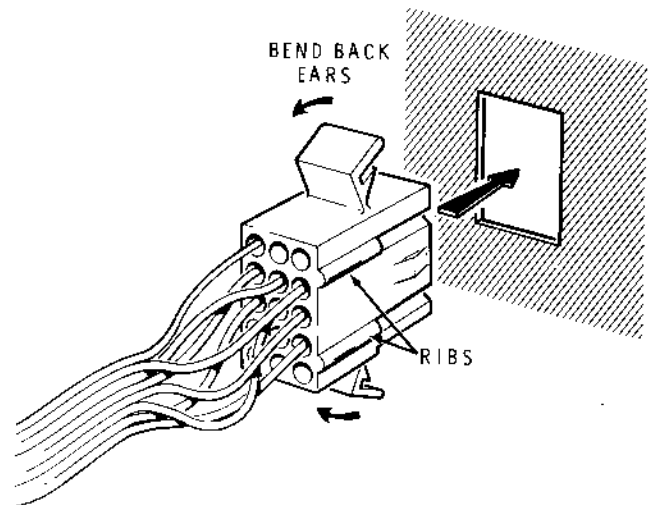

Detail 4-2A



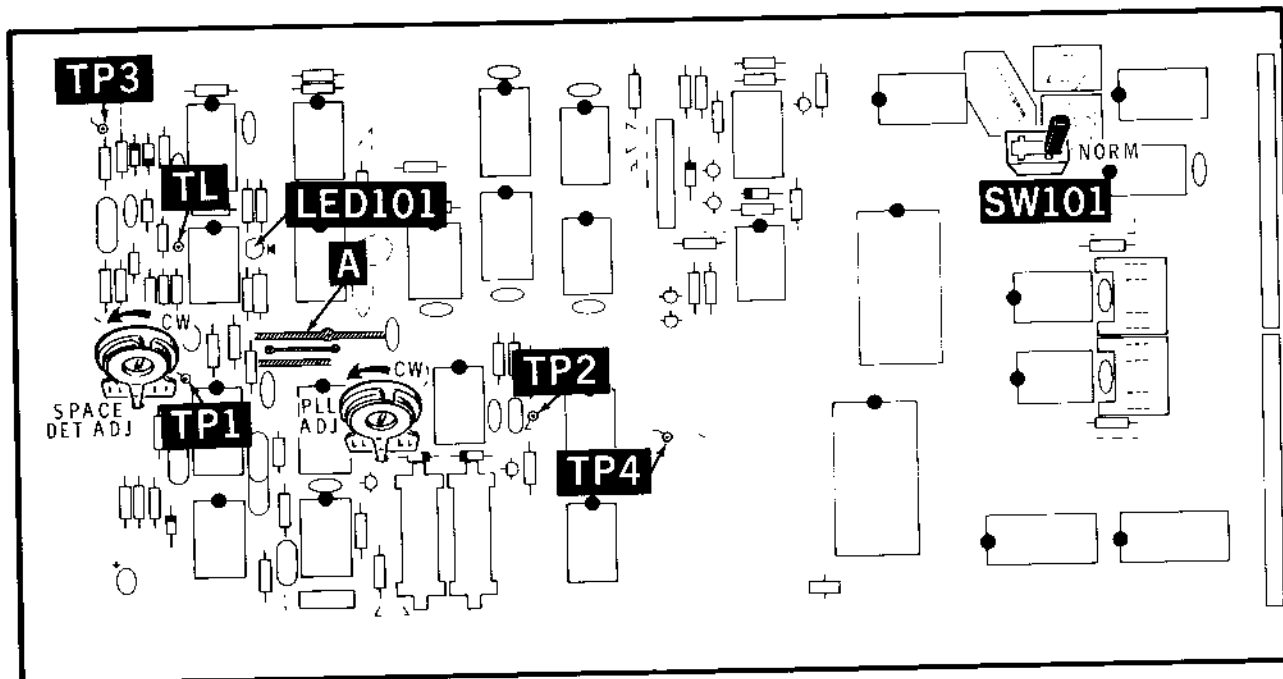

PICTORIAL 4-3

Refer to Pictorial 4-3 for the following steps.

**NOTE:** In the following steps, you will perform the adjustments. If at any time you do not get the proper indication, turn off the Computer, proceed to the "In Case of Difficulty" section on Page 54, and repair the problem. Then return to this section and complete the adjustments.

- ( ) Turn on the Computer. LED101 should not light.
- ( ) Turn off the Computer.
- ( ) Prepare a 2" and an 8" white wire.
- ( ) Plug one end of the prepared 2" white wire into circuit board hole TL.
- ( ) Turn on the Computer.
- ( ) Touch the free end of the white wire to foil A. LED101 should light.
- ( ) Turn off the Computer.
- ( ) Connect the free end of the 2" white wire to TP1.
- ( ) Connect the other prepared white wire from TP3 to TP4.
- ( ) Looking at the controls from the top of the Computer, turn the PLL ADJ control and the SPACE DET ADJ control fully clockwise.
- ( ) Turn on the Computer. LED101 should light.
- ( ) Turn the SPACE DET ADJ control counterclockwise until LED101 just goes out.
- ( ) Turn off the Computer and remove the two white wires.
- ( ) Connect the 8" white wire from TL to TP2.
- ( ) Turn on the Computer.
- ( ) Slowly adjust the PLL ADJ control fully counterclockwise. As you turn the control, notice the point (or points) where the LED flickers.
- ( ) Set the PLL ADJ control to the point where the LED flickers (or where it flickers most predominantly if there is more than one point).
- ( ) Slowly adjust the control through this point of flickering once or twice and then set it at the "null." (As you turned the control, the flickering slowed down, virtually stopped, and then started flickering again. The "null" is where the LED slows down and virtually stops between the two positions where it was flickering.
- ( ) Remove the 8" white wire.
- ( ) Reconnect the 2" white wire from TL to TP1. **NOTE:** You will leave the wire in this position. The LED will now always monitor tape input data.



- ( ) Set switch SW101 to NORM.

## TERMINAL TESTS

NOTE: If you do not have a terminal, proceed to "Cassette Interface Tests."

Refer to Pictorial 4-4 (Illustration Booklet, Page 3) for the following steps.

The following steps will test the operation of your terminal through the serial I/O port. The tests assume that:

- The serial I/O port is wired for 372.
- Port interchange switch SW101 is in the NORM position.
- The baud rate and interface signals have been selected and jumpered to match your terminal.

- ( ) If you have a Heath H9 Terminal, plug the round 8-wire cable into rear panel connector 3 of your Computer and the serial I/O connector on your terminal. If you have other than a Heath Terminal, proceed to the "Operation" section on Page 43, wire the end of the cable as necessary to be compatible with your terminal, and plug in into connector 3 on the rear panel of your Computer and into your terminal.
- ( ) If you have an H9 Terminal, be sure it was wired for 600 baud and the following keys are positioned properly.

BAUD RATE — Down.  
 FULL DUPLEX — Down.  
 OFF LINE — Up.  
 SCROLL — Down.

1. ( ) Simultaneously press the  $\emptyset$  and RST/ $\emptyset$  computer keys.
2. ( ) Press the MEM key. } Sends mode word
3. ( ) Enter 316 373. } to USART
4. ( ) Press the OUT key. }
5. ( ) Press the MEM key. } Sends command
6. ( ) Enter 005 373. } word to
7. ( ) Press the OUT key. } USART
8. ( ) Press the MEM key. } Sends letter "A"
9. ( ) Enter 101 372. } to terminal
10. ( ) Press the OUT key. }

(Each time you press the OUT key, an "A" is typed on the terminal.)

The following steps will input a character from the terminal and echo it back to the terminal.

- ( ) Reperform steps 1 through 7 above.
- ( ) Press the "—" key on the Computer.
- ( ) Press the "A" key on the terminal. (Nothing may happen that you can see.)
- ( ) Press the Computer IN key. (The left three digits of the Computer should change to 301 or 101.)
- ( ) Press the Computer OUT key. An "A" should be typed out each time you press the OUT key.
- ( ) Simultaneously press the  $\emptyset$  and RST/ $\emptyset$  keys.

## CASSETTE INTERFACE TESTS

NOTE: If you do not have a cassette recorder, or do not intend to use the cassette interface feature, then this completes the "Installation and Adjustments." Proceed to the "Operation" section and read that information.

Make the following connections to your recorder.

- ( ) Connect the audio cable with black tubing to the EXTERNAL SPEAKER or EARPHONE jack. NOTE: If you are using two tape machines, make this connection to the playback machine. See the inset drawing on Pictorial 4-4 (Illustration Booklet, Page 3).
- ( ) Connect the other audio cable to the AUX (RADIO or LINE) or MIC input jack. This depends on the jumpers you installed on the Card. NOTE: If you are using two tape machines, make this connection to the recording machine.
- ( ) Connect an unmarked (without sleeving) 2-wire cable (with subminiature plug) to the motor control jack (may be marked REMOTE). NOTE: If you are using two tape machines, make this connection to the recording machine.

Only perform the next step if you are using two tape machines.

- ( ) Connect the 2-wire cable with black tubing to the motor control jack (REMOTE) of the playback machine.

NOTE: The cassette interface is very flexible. While it will accept a wide range of input levels, you may have to experiment with the playback and record levels of your machine due to the differences in recorders.



High-level inputs to the interface will generally help by making up for some tape dropouts. However, too high a level will degrade the signal-to-noise ratio. The tone control should be set at either midrange or in the treble area. You may have to experiment to find the best settings for reliable operation.

**NOTE:** If you have two tape machines connected, use only the playback machine in the following steps.

- ( ) Turn on the tape recorder and put it in the PLAY mode. The motor should not start.
- ( ) Press the Computer LOAD key. The motor should start.
- ( ) Simultaneously press the  $\emptyset$  and RST/ $\emptyset$  keys. The recorder motor should stop.
- ( ) Push the recorder's STOP button.
- ( ) Put the Heath H8 software tape into the recorder with side one up. Be sure the tape is rewound. (Do not use the blank tape supplied with this Card.)
- ( ) Put the recorder in the play mode. (The tape will not move.)
- ( ) Press the Computer LOAD key. The tape will start. After several seconds, the Computer read-out will start displaying addresses, starting at 040100 and going upward.

**NOTE:** If the display does not start counting upward, adjust the playback level or tone control of your tape recorder. Then:

- Rewind the tape.
- Simultaneously press the Computer  $\emptyset$  and RST/ $\emptyset$  keys.
- Put the recorder in the PLAY mode.
- Press the Computer LOAD key. The program should now load into your Computer.
- ( ) When the tape finishes loading, the Computer will make a single beep and the tape will stop. If the Computer continues to beep:
  - Simultaneously press the  $\emptyset$  and RST/ $\emptyset$  keys.
  - Rewind the tape.
  - Press the Computer LOAD key.
  - Adjust the recorder's volume or tone control.
  - Press the recorder's PLAY button and load the tape into the Computer again.
  - Repeat these steps until the Computer gives a single beep when the tape stops. **NOTE:** Your software tape has two copies of each program on it. If necessary, locate the second copy of the editor program and load it.

The editor program is now loaded into the Computer. In the following steps you will make a copy of this program. Use the blank tape supplied with your kit.

- ( ) If you have only one machine connected, rewind the H8 software tape and remove it from the machine. You may have to remove the plug going to the "remote" jack.
- ( ) Advance the blank tape until all the leader is on the takeup reel and recording tape is exposed in the cassette opening.
- ( ) Insert the blank tape into the recorder and set the machine to record. (Set the record level if necessary.)
- ( ) Install the 2-wire cable (without the tubing) into the "remote" jack of the recorder.
- ( ) Press the Computer DUMP key. After a short delay, the displays will start to count up.
- ( ) When you hear the beep, the dump is finished.
- ( ) Again press the DUMP key to make a safety copy.
- ( ) Rewind the tape. It may be necessary to remove the motor control cable.
- ( ) If you are using two machines, move the tape to the playback machine.
- ( ) Reinstall the motor control cable.
- ( ) Put the machine in the play mode.
- ( ) Press the Computer LOAD key and the tape will load into the Computer as before.
- ( ) If your Terminal is connected, press the Computer GO key. The Terminal will print out the title label of the editor and the editor routine is ready for you to use. (See your Computer software Manual.)
- ( ) Simultaneously press the RST/ $\emptyset$  and  $\emptyset$  keys.
- ( ) Rewind the tape.
- ( ) Stop the recorder and remove the tape.
- ( ) Again refer to Pictorial 4-1 and replace the tie bracket and top cover. Use another 6-32  $\times$  1/4" screw to hold the Serial Card to the tie bracket.

This completes the "Installation and Adjustments." Proceed to the "Operation" section and read that information.

## OPERATION

Your Serial I/O and Cassette Interface Card is very sophisticated and yet flexible. Many of its functions can be changed by moving jumpers or through software programming. This section of the Manual will help you fit the Card to your needs and take full advantage of its capabilities.

### SERIAL I/O PORT

The signals that the serial I/O port uses to communicate with the terminal may be one of three types; EIA RS-232C compatible, 20 mA active current loop, or 20 mA passive current loop. The type you select must match that used by your terminal. The RS-232 levels are normally used by CRT terminals and other high speed devices. The 20 mA loops are used with teletypes or whenever very long lines are used between units.

### RS-232 Levels

To use the RS-232 levels, you should have installed the three EIA jumpers and none of the TTY jumpers. (See Page 28 of the "Step-by-Step Assembly.") The cable coming from connector 3 on the rear of the Computer connects to your terminal as shown below in Pictorial 5-1.

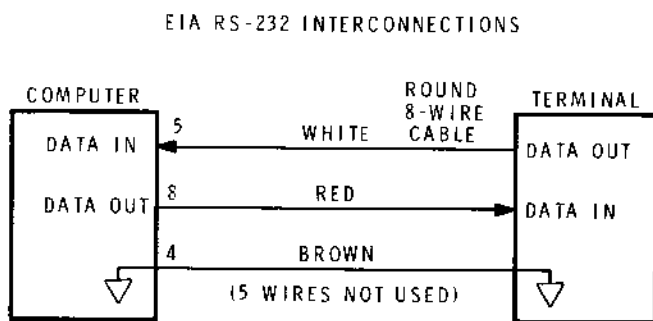

PICTORIAL 5-1

### 20 mA Active Current Loop

The 20 mA active current loop is used when the serial I/O interface is to supply the current for the loop. This is normally the mode used with a teletypewriter or other passive device. To use this mode, you should have installed circuit board jumpers at the three TTY locations and none at the EIA locations. The cable coming from connector 3 on the rear panel of your Computer connects as shown in Pictorial 5-2.

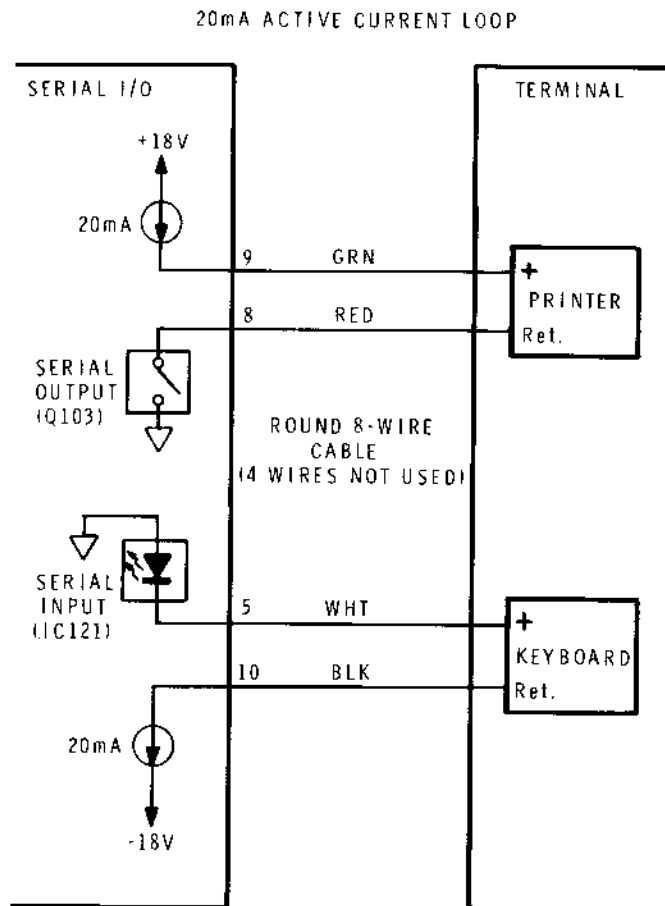

PICTORIAL 5-2

## 20 mA Passive Current Loop

The 20 mA passive current loop is used when you connect the serial I/O port into a loop where another interface supplies the current. This might occur if you connect two computers together. To use this mode, only the TTY jumper near IC122 should be installed. (See Pictorial 2-2 on Page 28.) The cable coming from connector 3 on the rear panel of your Computer connects as shown in Pictorial 5-3.

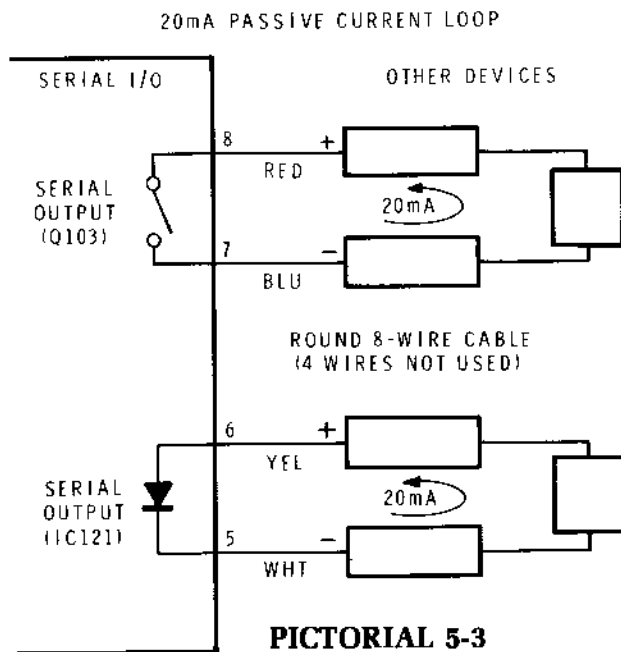

## Port Interchange Switch

The port interchange switch allows you to use a teletypewriter that has a paper punch and reader for both the system console and the load/dump port. With the switch in the NORMAL position, the teletypewriter is used as the system console, and the load and dump routines will address the magnetic tape interface. With the switch in the PORT INTCHG position, the teletypewriter (along with its paper tape punch and reader) will respond to the load and dump routines. See the software manual (supplied with your Computer) for instructions or how to reassign the system console address.

## COPYING TAPES

The Cassette Interface provides the greatest reliability when tapes are played back by the same machine on which they were recorded. Therefore, it is recommended that you make a copy of the H8 software tape. This will give you maximum reliability when loading tapes and the original can be used as a backup copy if something happens to the work copy.

## CASSETTE INTERFACE

Data is stored on magnetic tape one bit at a time as the tape moves past the record head. The data rate is 300 or 1200 bits per second. Since the tape moves at 1-7/8" per second, at 1200 bits per second, there will be 640 bits on each inch of tape. This means that each bit is only .0016 inches long. If a single bit is lost, the program will not run. Obviously, small defects in the tape which are not noticeable on audio recordings will be disastrous to a data storage tape. Tape defects, dust, smoke, and improper tape handling will all cause loss of data. Therefore, be very careful with your tapes.

Choose a good recorder.\* One of the two biggest factors in reliability is the recorder you select. It will need an external speaker or earphone output jack and an auxiliary, radio, or microphone input jack. A motor control jack will make your system easier to operate but it is not essential. Preferably, choose a recorder that is designed to record music. Clean the tape head regularly and be sure it is free of dust. (NOTE: For tape head alignment instructions, see Page 53.)

Tape is the other biggest factor in reliability. Choose top quality tape in a well-designed housing. Use the type of tape your recorder was designed for, chromium dioxide if possible. Choose one of the shorter tapes (C-30); the tape is thicker.

To protect your tapes follow these precautions:

1. Always rewind a tape before you remove it from the recorder. This prevents contamination and scratching.
2. Always store a tape in its protective case.
3. Do not touch the tape or the leader.
4. Never place tapes near magnetic fields, as generated by motors, magnets, or TV SETS.
5. Do not expose tapes to direct sunlight or high temperatures.
6. Always have duplicate copies of all valuable tapes; like system software tapes.

\*All Heath computer hardware and software products were designed to work together as a complete system. Proper operation can be assured only when the computers are used with Heath designed or approved accessories. Heath does not assume the responsibility for improper operation resulting from custom interfacing, custom software, or the use of accessories not approved by Heath Company.



When you set up your system, you may have to experiment to find the best settings for the volume control, tone control, or both. The tone control is normally set to midrange or toward the treble end. The volume control is not critical on playback once the minimum level is reached. Increasing the volume will sometimes be helpful when using poor recordings.

If your recorder has an automatic level control, defeat it if possible. Use the record level control to set the level to the highest level before overloading.

If you want to use a cassette deck that does not have a power amplifier, remove R101 from the Serial I/O and Cassette Interface Card to raise the impedance of the audio input.

If you have two tape machines, you can use one for playback while you record on the other. To do this, use the audio cable and the 2-wire cable with black tubing for the playback machine. Use the other two cables for the recording machines. See the inset drawing on Pictorial 4-4.

### CASSETTE INTERFACE DISABLE

When you use the H10 Reader/Punch and the H8-2 Parallel Card as the load/dump port, the Cassette Interface must be disabled. To do this, remove the "Y" to "O" port select jumper. Be sure to disable the parallel port at address 370 and reinstall this jumper when you want to use the Cassette Interface again.

### PROGRAMMING CONSIDERATIONS

The 8251 USARTs (IC123 and IC124) perform the serial-to-parallel data conversion and are very flexible devices. The manner in which they perform the conversion is determined by the external clocks and the control words sent from the central processing unit. For most applications, the software supplied by Heath Company will automatically take care of this. However, for specialized applications, you might need to know how to initialize and use these devices.

The following is a general set of requirements needed to properly operate the USARTs. This information is then followed by more technical and detailed information.

The following sequence of events must happen for a USART to work properly:

1. At power-up, or following a master reset, the USART is reset.
2. A MODE INSTRUCTION is sent to the USART defining the following characteristics of the I/O channel:
  - Clock rate.
  - Character length.
  - Parity.
  - Number of stop bits.

The Mode Instruction is a word sent by the CPU to the USART register at the odd-numbered port of the two ports assigned to each USART. The normal mode instruction for the Heath system is 116, which programs the USART for standard asynchronous operation.

3. A COMMAND INSTRUCTION is sent to the same port as the mode instruction. This word controls the actual operation of the USART. It enables portions of the circuitry, sets various bits, and resets the error flags.
4. A STATUS WORD may be read from this same port. It allows the CPU to determine when data may be transferred, which bits are set, and which errors have occurred.
5. Data is transferred between the USART and the CPU through the even-numbered port of the two ports assigned to each USART. (This is the port number which is actually programmed at the port decoder.) The mode and command instructions use the next higher port number.

NOTE: A New Command Instruction may be sent to the USART at any time. If, however, the USART had a character in its transmit buffer, that character would be lost.

### USART DESCRIPTION

The following is Manufacturer's data concerning the USART and is supplied for your information. However, not all the information is applicable to your Serial Card.

The 8251 is a Universal Synchronous/Asynchronous Receiver/Transmitter (USART) Chip designed for data communications in microcomputer systems. The USART is used as a peripheral device and is programmed by the CPU to operate using virtually any serial data transmission technique presently in use (including IBM Bi-Sync). The USART accepts data characters from the CPU in parallel format and then converts them into a continuous serial data stream for transmission. Simultaneously it can receive serial data streams and convert them into parallel data characters for the CPU. The USART will signal the CPU whenever it can accept a new character for transmission or whenever it has received a character for the CPU. The CPU can read the complete status of the USART at any time. These include data transmission errors and control signals such as SYNDET, TxEMPTY. The chip is constructed using N-channel silicon gate technology. See Pictorial 5-4.

The USART has the following features:

- Synchronous and Asynchronous Operation
  - Synchronous:
    - 5-8 Bit Characters
    - Internal or External Character Synchronization
    - Automatic Sync Insertion
- Asynchronous:
  - 5-8 Bit Characters
  - Clock Rate — 1, 16, or 64 Times Baud Rate
  - Break Character Generation
  - 1, 1-1/2, or 2 Stop Bits
  - False Start Bit Detection
- Baud Rate — DC to 56 k Baud (Sync Mode)  
DC to 9.6 k Baud (Async Mode)
- Full Duplex, Double Buffered, Transmitter and Receiver
- Error Detection — Parity, Overrun, and Framing
- Fully Compatible with 8080 CPU
- 28-Pin DIP Package
- All Inputs and Outputs are TTL Compatible
- Single 5-Volt Supply
- Single TTL Clock

**PIN CONFIGURATION**

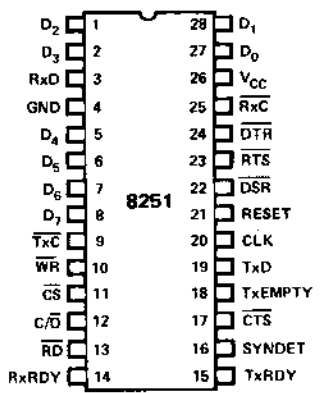

Pin Name	Pin Function
D7-D0	Data Bus (8 bits)
C/D	Control or Data is to be Written or Read
RD	Read Data Command
WR	Write Data or Control Command
CS	Chip Enable
CLK	Clock Pulse (TTL)
RESET	Reset
TxC	Transmitter Clock
TxD	Transmitter Data
RxC	Receiver Clock
RxD	Receiver Data
RxRDY	Receiver Ready (has character for 8080)
TxRDY	Transmitter Ready (ready for char. from 8080)

Pin Name	Pin Function
DSR	Data Set Ready
DTR	Data Terminal Ready
SYNDET	Sync Detect
RTS	Request to Send Data
CTS	Clear to Send Data
TxE	Transmitter Empty
Vcc	+5 Volt Supply
GND	Ground

**BLOCK DIAGRAM**

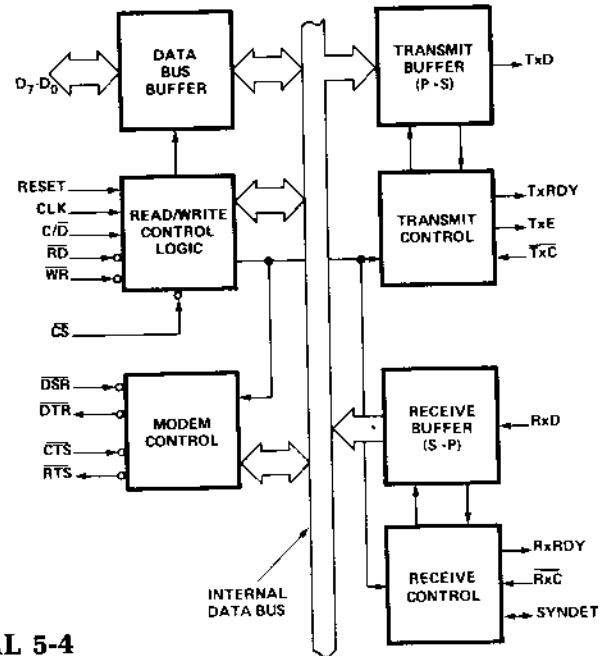

**PICTORIAL 5-4**

Portions of this section are reprinted by permission from Intel Corporation.



## 8251 BASIC FUNCTIONAL DESCRIPTION

### General

The 8251 is a Universal Synchronous/Asynchronous Receiver/Transmitter designed specifically for the 8080 Microcomputer System. Like other I/O devices in the 8080 Microcomputer System, its functional configuration is programmed by the system's software for maximum flexibility. The 8251 can support virtually any serial data technique currently in use (including IBM "bi-sync").

In a communication environment, an interface device must convert parallel format system data into serial format for transmission and convert incoming serial format data into parallel system data for reception. The interface device must also delete or insert bits or characters that are functionally unique to the communication technique. In essence, the interface should appear "transparent" to the CPU.

### Data Bus Buffer

This 3-state, bi-directional, 8-bit buffer is used to interface the 8251 to the 8080 system Data Bus. Data is transmitted or received by the buffer upon execution of INput or OUTput instructions of the 8080 CPU. Control words, Command words, and Status information are also transferred through the Data Bus Buffer.

### Read/Write Control Logic

This functional block accepts inputs from the 8080 Control bus and generates control signals for overall device operation. It contains the Control Word Register and Command Word Register that store the various control formats for device functional definition.

**RESET (Reset)** — A "high" on this input forces the 8251 into an "Idle" mode. The device will remain at "Idle" until a new set of control words is written into the 8251 to program its functional definition.

**CLK (Clock)** — The CLK input is used to generate internal device timing and is normally connected to the Phase 2 (TTL) output of the 8224 Clock Generator. No external inputs or outputs are referenced to CLK but the frequency of CLK must be greater than 30 times the Receiver or Transmitter clock inputs for synchronous mode (4.5 times for asynchronous mode).

**$\overline{WR}$  (Write)** — A "low" on this input informs the 8251 that the CPU is outputting data or control words; in essence, the CPU is writing out to the 8251. See Pictorial 5-5.

C/ $\overline{D}$	$\overline{RD}$	$\overline{WR}$	$\overline{CS}$	
0	0	1	0	8251 $\Rightarrow$ DATA BUS
0	1	0	0	DATA BUS $\Rightarrow$ 8251
1	0	1	0	STATUS $\Rightarrow$ DATA BUS
1	1	0	0	DATA BUS $\Rightarrow$ CONTROL
X	X	X	1	DATA BUS $\Rightarrow$ 3-STATE

### PICTORIAL 5-5

**$\overline{RD}$  (Read)** — A "low" on this input informs the 8251 that the CPU is inputting data or status information, in essence, the CPU is reading from the 8251.

**C/ $\overline{D}$  (Control/Data)** — This input, in conjunction with the  $\overline{WR}$  and  $\overline{RD}$  inputs informs the 8251 that the word on the Data Bus is either a data character, control word, or status information.

1 = CONTROL      0 = DATA

**$\overline{CS}$  (Chip Select)** — A "low" on this input enables the 8251. No reading or writing will occur unless the device is selected.

### Modem Control

The 8251 has a set of control inputs and outputs that can be used to simplify the interface to almost any Modem. The modem control signals are general-purpose in nature and can be used for functions other than Modem control, if necessary.

**$\overline{DSR}$  (Data Set Ready)** — The  $\overline{DSR}$  input signal is general-purpose in nature. Its condition can be tested by the CPU using a Status Read operation. The  $\overline{DSR}$  input is normally used to test Modem conditions such as Data Set Ready.

**$\overline{DTR}$  (Data Terminal Ready)** — The  $\overline{DTR}$  output signal is general-purpose in nature. It can be set "low" by programming the appropriate bit in the Command Instruction word. The  $\overline{DTR}$  output signal is normally used for Modem control such as Data Terminal Ready or Rate Select.

**$\overline{RTS}$  (Request to Send)** — The  $\overline{RTS}$  output signal is general-purpose in nature. It can be set "low" by programming the appropriate bit in the Command Instruction word. The  $\overline{RTS}$  output signal is normally used for Modem control such as Request to Send.



$\overline{\text{CTS}}$  (Clear to Send) — A “low” on this input enables the 8251 to transmit data (serial) if the Tx EN bit in the Command byte is set to a “one.”

### Transmitter Buffer

The Transmitter Buffer accepts parallel data from the Data Bus Buffer, converts it to a serial bit stream, inserts the appropriate characters or bits (based on the communication technique), and outputs a composite serial stream of data on the TxD output pin.

### Transmitter Control

The Transmitter Control manages all activities associated with the transmission of serial data. It accepts and issues signals both externally and internally to accomplish this function.

TxRDY (Transmitter Ready) — This output signals the CPU that the transmitter is ready to accept a data character. It can be used as an interrupt to the system or, for the Polled operation, the CPU can check TxRDY using a status read operation. TxRDY is automatically reset when a character is loaded from the CPU.

TxE (Transmitter Empty) — When the 8251 has no characters to transmit, the TxE output will go “high.” It resets automatically upon receiving a character from the CPU. TxE can be used to indicate the end of a transmission mode, so that the CPU “knows” when to “turn the line around” in the half-duplexed operational mode.

In SYNChronous mode, a “high” on this output indicates that a character has not been loaded and the SYNC character or characters are about to be transmitted automatically as “fillers.”

$\overline{\text{TxC}}$  (Transmitter Clock) — The Transmitter Clock controls the rate at which the character is to be transmitted. In the Synchronous transmission mode, the frequency of  $\overline{\text{TxC}}$  is equal to the actual Baud Rate (1X). In Asynchronous transmission mode, the frequency of  $\overline{\text{TxC}}$  is a multiple of the actual Baud Rate. A portion of the mode instruction selects the value of the multiplier; it can be 1x, 16x, or 64x the Baud Rate.

For example:

	If Baud Rate equals 110 Baud,
	$\overline{\text{TxC}}$ equals 110 Hz (1x)
	$\overline{\text{TxC}}$ equals 1.76 kHz (16x)
	$\overline{\text{TxC}}$ equals 7.04 kHz (64x).
	If Baud Rate equals 9600 Baud,
	$\overline{\text{TxC}}$ equals 614.4 kHz (64x).

The falling edge of  $\overline{\text{TxC}}$  shifts the serial data out of the 8251.

### Receiver Buffer

The Receiver accepts serial data, converts this serial input to parallel format, checks for bits or characters that are unique to the communication technique and sends an “assembled” character to the CPU. Serial data is input to the RxD pin.

### Receiver Control

This functional block manages all receiver-related activities.

RxRDY (Receiver Ready) — This output indicates that the 8251 contains a character that is ready to be input to the CPU. RxRDY can be connected to the interrupt structure of the CPU or for Polled operation the CPU can check the condition of RxRDY using a status read operation. RxRDY is automatically reset when the character is read by the CPU.

$\overline{\text{RxC}}$  (Receiver Clock) — The Receiver Clock controls the rate at which the character is to be received. In Synchronous Mode, the frequency of  $\overline{\text{RxC}}$  is equal to the actual Baud Rate (1x). In Asynchronous Mode, the frequency of  $\overline{\text{RxC}}$  is a multiple of the actual Baud Rate. A portion of the mode instruction selects the value of the multiplier; it can be 1x, 16x, or 64x the Baud Rate.

For example:

	If Baud Rate equals 300 Baud,
	$\overline{\text{RxC}}$ equals 300 Hz (1x)
	$\overline{\text{RxC}}$ equals 4800 Hz (16x)
	$\overline{\text{RxC}}$ equals 19.2 kHz (64x).
	If Baud Rate equals 2400 Baud,
	$\overline{\text{RxC}}$ equals 2400 Hz (1x)
	$\overline{\text{RxC}}$ equals 38.4 kHz (16x)
	$\overline{\text{RxC}}$ equals 153.6 kHz (64x).

Data is sampled into the 8251 on the rising edge of  $\overline{\text{RxC}}$ .

NOTE: In most communications systems, the 8251 will be handling both the transmission and reception operations of a single link. Consequently, the Receive and Transmit Baud Rates will be the same. Both  $\overline{\text{TxC}}$  and  $\overline{\text{RxC}}$  will require identical frequencies for this operation and can be tied together and connected to a single frequency source (Baud Rate Generator) to simplify the interface.

SYNDET (SYNC Detect) — This pin is used in SYNChronous Mode only. It is used as either input or output, programmable through the Control Word. It is reset to “low” upon RESET. When used as an output

(internal Sync mode), the SYNDET pin will go "high" to indicate that the 8251 has located the SYNC character in the Receive mode. If the 8251 is programmed to use double Sync characters (bi-sync), then SYNDET will go "high" in the middle of the last bit of the second Sync character. SYNDET is automatically reset upon a Status Read operation.

When used as an input (external SYNC detect mode), a positive going signal will cause the 8251 to start assembling data characters on the falling edge of the next  $\overline{RxC}$ . Once in SYNC, the "high" input signal can be removed. The duration of the high signal should be at least equal to the period of  $\overline{RxC}$ .

## DETAILED OPERATION DESCRIPTION

### General

The complete functional definition of the 8251 is programmed by the system's software. A set of control words must be sent out by the CPU to initialize the 8251 to support the desired communications format. These control words will program the: Baud Rate, Character Length, Number of Stop Bits, Synchronous or Asynchronous Operation, Even/Odd Parity, etc. In the Synchronous Mode, options are also provided to select either internal or external character synchronization.

Once programmed, the 8251 is ready to perform its communication functions. The TxRDY output is raised "high" to signal the CPU that the 8251 is ready to receive a character. This output (TxRDY) is reset automatically when the CPU writes a character into

the 8251. On the other hand, the 8251 receives serial data from the MODEM of I/O device. Upon receiving an entire character, the RxRDY output is raised "high" to signal the CPU that the 8251 has a complete character ready for the CPU to fetch. RxRDY is reset automatically upon the CPU read operation.

The 8251 cannot begin transmission until the TxEN (Transmitter Enable) bit is set in the Command Instruction and it has received a Clear To Send ( $\overline{CTS}$ ) input. The TxD output will be held in the marking state upon Reset.

### Programming the 8251

Prior to starting data transmission or reception, the 8251 must be loaded with a set of control words generated by the CPU. These control signals define the complete functional definition of the 8251 and must immediately follow a Reset operation (internal or external).

The control words are split into two formats:

1. Mode Instruction
2. Command Instruction

### Mode Instruction

This format defines the general operational characteristics of the 8251. It must follow a Reset operation (internal or external). Once the Mode instruction has been written into the 8251 by the CPU, SYNC characters or Command instructions may be inserted.

### Command Instruction

This format defines a status word that is used to control the actual operation of the 8251.

Both the Mode and Command instructions must conform to a specified sequence for proper device operation. (See Pictorial 5-6.) The Mode Instruction must be inserted immediately following a Reset operation, prior to using the 8251 for data communication.

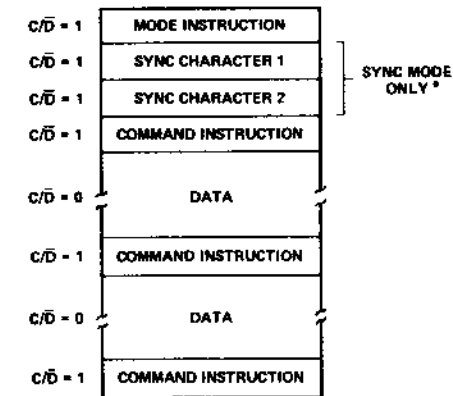

\*The second SYNC character is skipped if MODE instruction has programmed the 8251 to single character internal SYNC Mode. Both SYNC characters are skipped if MODE instruction has programmed the 8251 to ASYNC mode.

PICTORIAL 5-6

All control words written into the 8251 after the Mode Instruction will load the Command Instruction. Command Instructions can be written into the 8251 at any time in the data block during the operation of the 8251. To return to the Mode Instruction format, a bit in the Command Instruction word can be set to initiate an internal Reset operation which automatically places the 8251 back into the Mode Instruction format. Command Instructions must follow the Mode Instructions or Sync characters.

### Mode Instruction Definition

The 8251 can be used for either Asynchronous or Synchronous data communication. To understand how the Mode Instruction defines the functional operation of the 8251, the designer can best view the device as two separate components sharing the same package, one Asynchronous, the other Synchronous. The format definition can be changed "on the fly," but for explanation purposes, the two formats will be isolated.

Asynchronous Mode (transmission) — Whenever a data character is sent by the CPU, the 8251 automatically adds a Start bit (low level) and the programmed number of Stop bits to each character. (See Pictorials 5-7 and 5-8). Also, an even or odd Parity bit is inserted prior to the Stop bit(s), as defined by the Mode Instruction. The character is then transmitted as a serial data stream on the Tx<sub>D</sub> output. The serial data is shifted out on the falling edge of the Tx<sub>C</sub> at a rate equal to 1, 1/16, or 1/64 that of the Tx<sub>C</sub>, as defined by the Mode Instruction. Break characters can be continuously sent to the Tx<sub>D</sub> if commanded to do so.

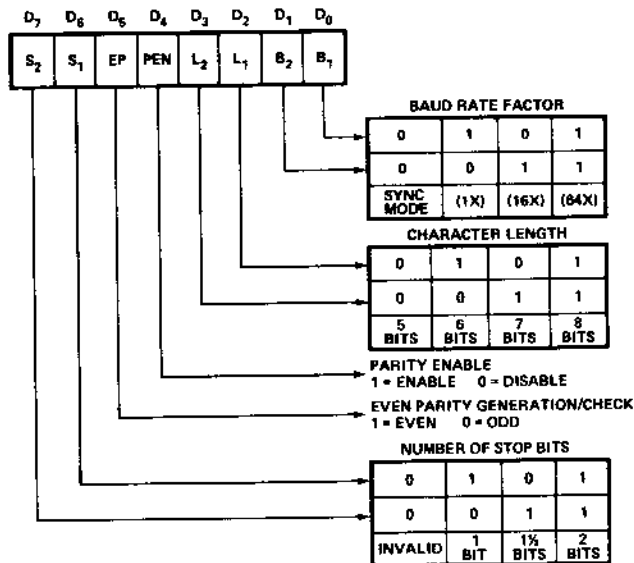

PICTORIAL 5-7

When no data characters have loaded into the 8251 the Tx<sub>D</sub> output remains "high" (marking) unless a Break (continuously low) has been programmed.

Asynchronous Mode (Receiver) — The Rx<sub>D</sub> line is normally high. A falling edge on this line triggers the beginning of a Start bit. The validity of this Start bit is checked by again strobing this bit at its nominal center. If a low is detected again, it is a valid Start bit, and the bit counter will start counting. The bit counter locates the center of the data bits, the parity bit (if it exists) and the Stop bits. If parity error occurs, the parity error flag is set. Data and parity bits are sampled on the Rx<sub>D</sub> pin with the rising edge of the Rx<sub>C</sub>. If a low level is detected as the Stop bit, the Framing Error flag will be set. The Stop bit signals the

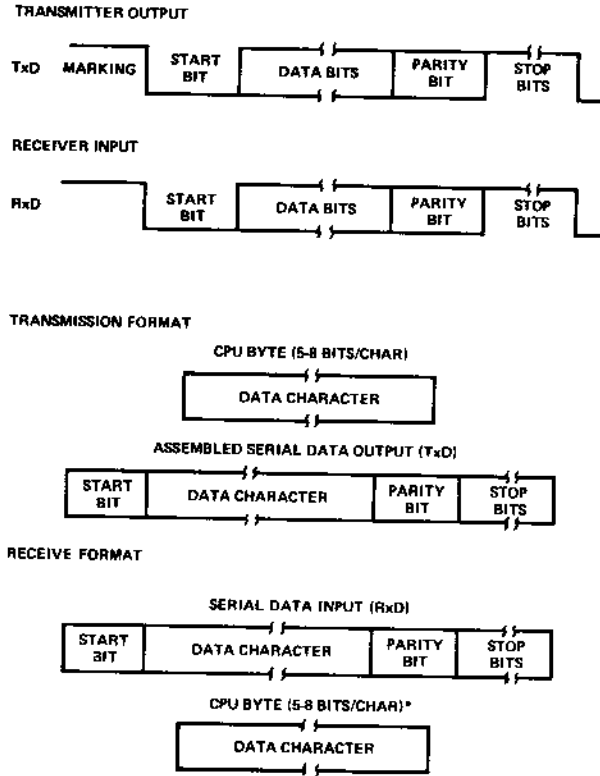

PICTORIAL 5-8

end of character. This character is then loaded into the parallel I/O buffer of the 8251. The RxRDY pin is raised to signal the CPU that a character is ready to be fetched. If a previous character has not been fetched by the CPU, the present character replaces it in the I/O buffer, and the Overrun flag is raised (thus the previous character is lost). All of the error flags can be reset by a command instruction. The occurrence of any of these errors will not stop the operation of the 8251.

**Synchronous Mode (Transmission)** — The TxD output is continuously high until the CPU sends its first character to the 8251, which usually is a SYNC character. (See Pictorials 5-9 and 5-10.) When the CTS line goes low, the first character is serially transmitted out. All characters are shifted out on the falling edge of Tx̄C. Data is shifted out at the same rate as the Tx̄C.

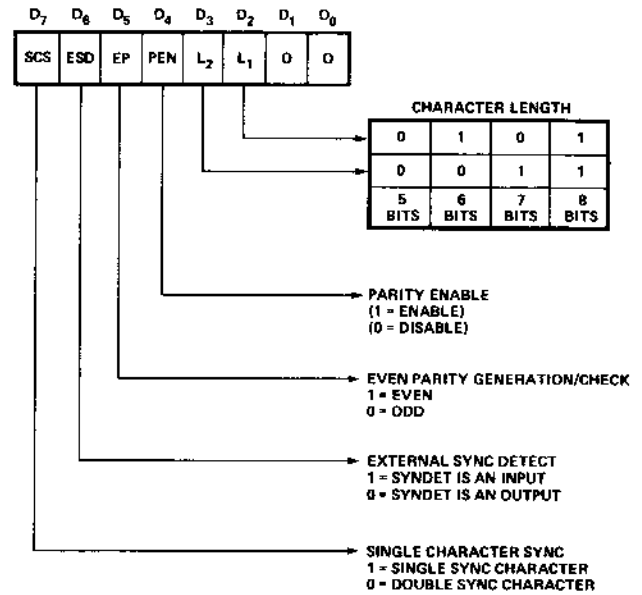

PICTORIAL 5-9

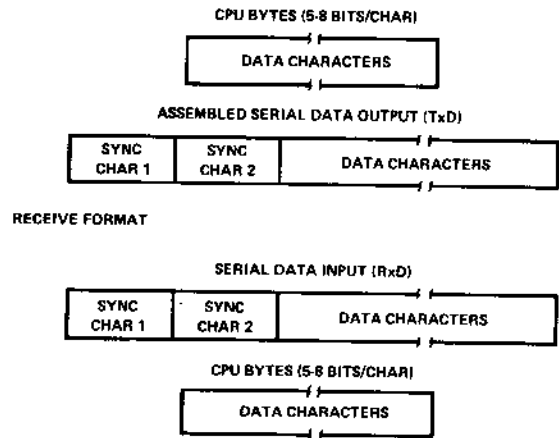

PICTORIAL 5-10

Once transmission has started, the data stream at TxD output must continue at the Tx̄C rate. If the CPU does not provide the 8251 with a character before the 8251 becomes empty, the SYNC characters (or character if in single SYNC word mode) will be automatically inserted in the TxD data stream. In this case, the TxEmpty pin is raised high to signal that the 8251 is empty and SYNC characters are being sent out. The TxEmpty pin is internally reset by the next character being written into the 8251.

**Synchronous Mode (Receive)** — In this mode, character synchronization can be internally or externally achieved. If the internal SYNC mode has been programmed, the receiver starts in a HUNT mode. Data on the RxD pin is then sampled in on the rising edge of  $\overline{RxC}$ . The content of the Rx buffer is continuously compared with the first SYNC character until a match occurs. If the 8251 has been programmed for two SYNC characters, the subsequent received character is also compared; when both SYNC characters have been detected, the USART ends the HUNT mode and is in character synchronization. The SYND $\overline{ET}$  pin is then set high, and is reset automatically by a Status Read.

In the external SYNC mode, synchronization is achieved by applying a high level on the SYND $\overline{ET}$  pin. The high level can be removed after one RxC cycle.

Parity error and overrun error are both checked in the same way as in the Asynchronous Rx mode.

The CPU can command the receiver to enter the HUNT mode if synchronization is lost.

**COMMAND INSTRUCTION DEFINITION**

Once the functional definition of the 8251 has been programmed by the Mode Instruction and the Sync Characters are loaded (if in Sync Mode), then the device is ready to be used for data communication. (See Pictorial 5-11.) The Command Instruction controls the actual operation of the selected format. Functions such as: Enable Transmit/Receive, Error Reset, and Modem Controls are provided by the Command Instruction.

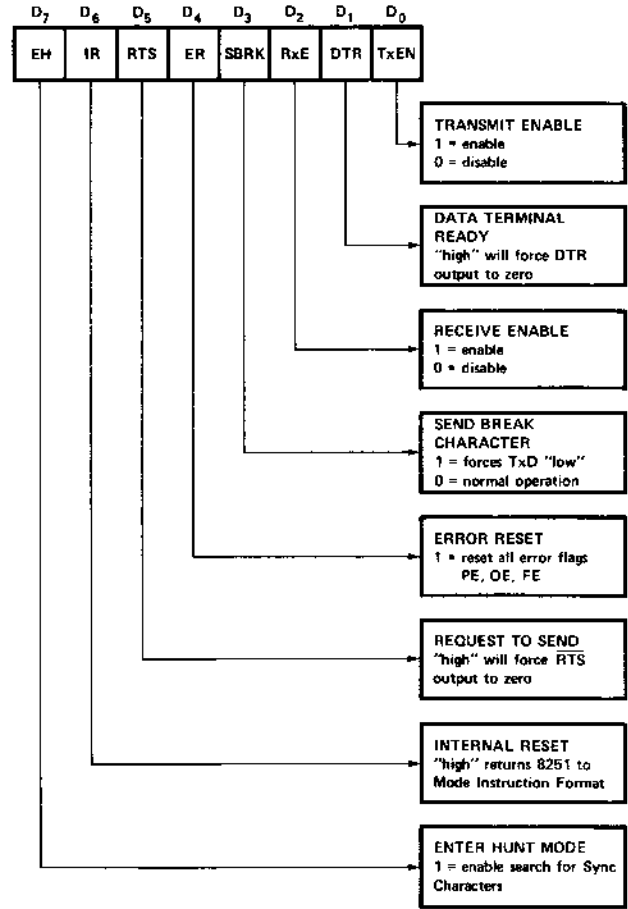

**PICTORIAL 5-11**

Once the Mode Instruction has been written into the 8251 and Sync characters inserted, if necessary, then all further "control writes" ( $C/\overline{D} = 1$ ) will load the Command Instruction. A Reset operation (internal or external) will return the 8251 to the Mode Instruction Format.

### STATUS READ DEFINITION

In data communication systems, it is often necessary to examine the "status" of the active device to ascertain if errors have occurred or other conditions that require the processor's attention. The 8251 has facilities that allow the programmer to "read" the status of the device at any time during the functional operation. See Pictorial 5-12.

A normal "read" command is issued by the CPU with the C/D input at one to accomplish this function.

Some of the bits in the Status Read Format have identical meanings to external output pins so that the 8251 can be used in a completely Polled environment or in an interrupt driven environment.

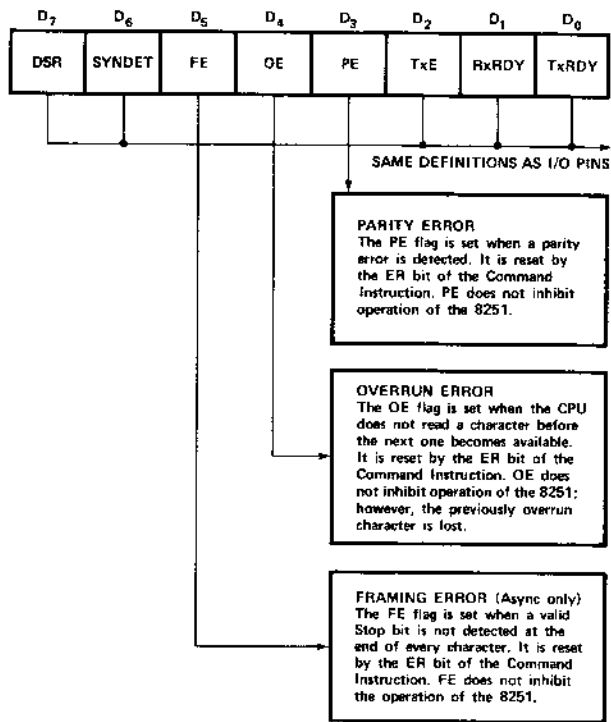

PICTORIAL 5-12

## IN CASE OF DIFFICULTY

This section of the Manual is divided into two parts. The first part, titled "Troubleshooting and Repair Precautions," points out the care that you should use when you service the unit to prevent damaging components.

The second part, titled "Troubleshooting Chart" gives difficulties and likely causes.

If the "Troubleshooting Chart" does not help you locate the problem, read the "Circuit Description" and refer to the Schematic Diagram (fold-in) to help you determine where the trouble is. Refer to the X-Ray View (Illustration Booklet, Page 6) for the physical location of parts on the circuit board.

NOTE: In an extreme case where you are unable to resolve a difficulty, refer to the "Customer Service" information inside the rear cover of the Manual. Your Warranty is located inside the front cover.

## Troubleshooting and Repair Precautions

1. Make sure you do not short any adjacent terminals or foils when you make tests or voltage measurements. If a probe or test lead should slip, for example, and short together two adjacent connections, it is very likely to damage one or more of the transistors, diodes, or IC's.
2. Be especially careful when you test any circuit that contains an IC or a transistor. Although these components have an almost unlimited life when used properly, they are much more vulnerable to damage from excess voltage and current than many other parts.
3. Do not remove any components while the unit is turned on.
4. Handle MOS IC's properly. Static electricity can damage them.
5. When you make repairs, make sure you eliminate the cause as well as the effect of the trouble. If, for example, you find a damaged resistor, be sure you find out what damaged the resistor. If the cause is not eliminated, the replacement resistor may also become damaged when you put the unit back into operation.
6. In several areas of the circuit boards, the foil patterns are quite narrow. When you unsolder a part to check or replace it, avoid excessive heat while you remove the part. A suction-type desoldering tool makes part removal easier.

### COMPONENTS

To remove faulty resistors or capacitors; first clip them from their leads, then heat the solder on the foil and allow each lead to fall out of its hole. Preshape the leads of the replacement part and insert them into the holes in the circuit board. Solder the leads to the foil and cut off the excess lead lengths.

You can remove transistors in the same manner as resistors and capacitors. Make sure you install the replacement transistor with its leads in the proper holes. Then solder the leads quickly to avoid heat damage. Cut off the excess lead lengths.

### FOIL REPAIR

To repair a break in a circuit board foil, bridge solder across the break. Bridge large gaps in the foil with bare wire. Lay the wire across the gap and solder each end to the foil. Carefully trim off any excess bare wire.

## Troubleshooting Chart

The following chart lists the "Problem" and the "Possible Cause" for a number of malfunctions. If a particular part is mentioned (transistor Q101, for example, or resistor R104) as a possible cause, check to see if it was incorrectly installed or wired. Also check to see if an improper part was installed at that location. It is possible, on rare occasions, for a part to be faulty.

PROBLEM	POSSIBLE CAUSE
LED101 does not light.	<ol style="list-style-type: none"> <li>1. 5-volt supply, IC133.</li> <li>2. IC102.</li> <li>3. LED101.</li> </ol>
Space detector does not adjust, but PLL adjusts OK.	<ol style="list-style-type: none"> <li>1. IC101, IC102, IC103.</li> <li>2. R113.</li> </ol>
PLL does not adjust, but space detector adjusts OK.	<ol style="list-style-type: none"> <li>1. IC106, IC107, IC108.</li> <li>2. R119.</li> <li>3. Hi/Lo jumper wires installed incorrectly.</li> </ol>
Both space detector and PLL will not adjust.	<ol style="list-style-type: none"> <li>1. Y101.</li> <li>2. IC112 and IC127 interchanged.</li> <li>3. IC112, IC113, IC114, IC115, IC116.</li> </ol>
Both adjustments are OK, but neither cassette nor serial I/O will communicate with CPU.	<ol style="list-style-type: none"> <li>1. Port interchange switch not in NORM position.</li> <li>2. Wrong port numbers jumpered.</li> <li>3. IC131 and IC132 interchanged.</li> <li>4. IC118, IC125, IC126, IC127, IC131, IC132.</li> </ol>
Cassette interface inoperative. Both adjustments OK. Serial I/O OK.	<ol style="list-style-type: none"> <li>1. Cables improperly connected.</li> <li>2. Tape.</li> <li>3. "Tape Tx" not connected to 1200 baud clock.</li> <li>4. IC104, IC105, IC111, IC123.</li> </ol>
Serial I/O interface inoperative. Cassette interface OK.	<ol style="list-style-type: none"> <li>1. Cables improperly connected.</li> <li>2. Wrong clock jumpered for terminal used.</li> <li>3. Wrong signal levels selected or improperly jumpered.</li> <li>4. Q103, Q104, Q105.</li> <li>5. IC119, IC121, IC122, IC124.</li> </ol>
Cassette interface erratic.	<ol style="list-style-type: none"> <li>1. Low quality tapes used.</li> <li>2. Dirty tape heads.</li> <li>3. Worn tape machine.</li> <li>4. Level, or tone, or both not adjusted properly.</li> <li>5. Loose cables.</li> <li>6. Adjustments not performed properly.</li> </ol>
Cassette motor continues to run after load or dump is complete.	<ol style="list-style-type: none"> <li>1. RL101, RL102.</li> <li>2. Q101, Q102.</li> </ol>



## SPECIFICATIONS

### SERIAL INTERFACE

Data Rate .....	110, 150, 300, 600, 1200, 2400, 4800, or 9600 baud
Output Levels .....	20 mA current loop or RS-232 compatible levels.
USART Programming Options	
Clock Rate Factor .....	1, 16, or 64.
Character Length .....	5, 6, 7, or 8 bits.*
Parity .....	Even, odd, or disabled.
Number of Stop Bits .....	1, 1-1/2, or 2.

### CASSETTE INTERFACE

Data Rate .....	300 or 1200 baud.
Mark Frequency .....	2400 Hz.
Space Frequency .....	1200 Hz.
Audio Output Level .....	500 mV peak-to-peak or
(Into High Impedance)	50 mV peak-to-peak.
Input Sensitivity .....	500 mV rms.
Input Impedance .....	100 $\Omega$ .
Speed Tolerance .....	$\pm 33\%$ of recorded speed (wow + flutter + speed difference).
Motor Control .....	200 VDC maximum.
Contact Ratings	500 mA DC maximum.

### GENERAL

Power Requirements .....	+8 VDC at 600 mA typical.
(From H8 Bus) .....	+18 VDC at 20 mA typical.
	-18 VDC at 20 mA typical.
Operating Temperature .....	0° to 40° Celcius.

---

The Heath Company reserves the right to discontinue products and to change specifications at any time without incurring any obligation to incorporate new features in products previously sold.

\*NOTE: H8 software will not accept Baudot characters.



## CIRCUIT DESCRIPTION

As you read this section, refer to the Block Diagram (Illustration Booklet, Page 4) and the Schematic (fold-in).

The Serial I/O and Cassette Interface Card consists of two serial data channels. One channel is used for the cassette interface, and the other channel is buffered and used as a serial I/O port. These channels communicate with the CPU (central processing unit) through three parallel buses, an 8-bit data bus, the control bus, and the eight low-order bits of the address bus. The USARTs (universal synchronous asynchronous receiver transmitter) convert this data to a serial format to communicate with the peripheral devices.

### CASSETTE INTERFACE

Digital data is recorded on standard audio tape as two audio tones, 1200 Hz for a space (logic 0) and 2400 Hz for a mark (logic 1). The cassette interface serially reads these tones and also supplies the tones to a recorder.

### Limiter and Slicer

The audio output from the tape player is applied across load resistor R101, through R102, to limiting diodes D101 and D102. These diodes limit the input signal so that IC102A is not overdriven by large input signals. The output of the comparator is low during the positive half cycle of the input and high during the negative half cycle. (See the Timing Diagram in the Illustration Booklet, Page 5.) Resistors R107 and R108 provide hysteresis to ensure a proper square wave for the following digital circuitry.

### Frequency Doubler

IC101A is a monostable multivibrator which is triggered on the positive edge of the signal from IC102A. IC101B is also a monostable but it is triggered on the negative edge of the same signal. As shown in the Timing Diagram, the outputs are short pulses. These pulses are combined in IC108A and are used to clock the rest of the circuitry.

### Space Detector

IC103A is a retriggerable monostable which is triggered by the signal from IC108A. The pulse width at the output of this monostable (in the Timing Diagram) is set so that a 2400 Hz input will keep the monostable triggered, while a 1200 Hz input will allow it to time out.

The space detector adjustment is made by connecting an 1800 Hz signal to the audio input and adjusting the monostable so that it almost times out before it is retriggered. If the monostable does time out, TP1 will pulse high and cause test lamp LED101 to light. When the LED just goes out, the period of the monostable is adjusted properly.

### Data Latch

The output from monostable IC103B at the end of each cycle is latched by IC104A on the positive-going edge of the signal from IC108A. The output from IC104A is the recovered digital data. If a 1200 Hz input had been present, IC103B would have timed out and its output would have been low when IC104A sampled it. This results in a "space" (Logic Low) being detected. If a 2400 Hz input had been present, IC103B would be retriggered before it could time out and its output would have been high when IC104A sampled it. This results in a "mark" (Logic High) being detected. IC104B is a data latch and retains the last mark bit of the data stream. The output of IC104B is fed through IC117C to the serial data input of USART IC123.

### Controlled Divider

IC105A will divide by two if the audio input is 2400 Hz or it will divide by one if the input is 1200 Hz. Thus the output of IC105A will always be of the same frequency, for either 1200 or 2400 Hz inputs. This signal is used to generate the clock required to drive the USART. IC105B divides the output from IC105A by two to provide a symmetrical square wave for the phase-locked loop.

IC105A is clocked by the pulses from IC108A. If it is not set by IC103A, IC105A will toggle on each positive edge and divide the frequency of the signal by two. For a 2400 Hz audio input, the output of IC103B will stay high and IC103A will not be triggered; thus IC105A will divide by two.

For a 1200 Hz audio input, the output of IC103B will go low during each cycle, which then triggers IC103A. IC103A is a monostable multivibrator which puts out a short pulse for each negative transition at its input. This pulse sets IC105A. At the beginning of the cycle, IC105A was toggled to the reset state and is now being set again. Thus the output of IC105A goes through a complete cycle for each cycle of the signal at pin 3 if the input signal was 1200 Hz; so it divides by one.

### Phase Locked Loop Clock Synthesizer

IC106 and IC107 form a phase locked loop which multiplies the frequency of the output signal from IC105B by 16. The output from IC105B is used as the reference input to the phase detector of IC106. The feedback for the loop is provided by IC107, which divides the output of IC106 by 16. The output of the phase detector inside IC106 is filtered by R122, R123, and C108; and fed to the voltage-controlled oscillator section. The frequency of the VCO is determined by R118, R119, and C107.

The phase detector produces a signal which is proportional to the difference in frequency of its two input signals (pins 14 and 3). This signal controls the VCO whose output is then divided by 16 in IC107 and fed back to the phase detector input. If the two input frequencies are to be the same (loop locked), then the output frequency must be exactly 16 times the reference frequency applied to pin 14. This results in a multiplication of the reference frequency by 16. The signal from IC108B is used as the receiver clock input to USART IC123. Since the clock is derived from the data on the tape, the speed of the tape is not critical.

The phase locked loop is adjusted for a center frequency of 19,200 Hz. This is done by "ANDing" a 2400 Hz signal from the clock scaler with the output of IC107 which will also be 2400 Hz when the PLL is adjusted properly. When both signals are of the same frequency, but 180° out of phase, the output of IC117A will always be low. When the signals differ slightly in frequency, the output of IC117A (TP2) will pulse slightly which can be seen with the test lamp. When the frequencies differ greatly, the lamp will glow steadily.

### Frequency Shift Keying Modulator

The transmit data from USART IC123 is inverted by IC112A and fed to IC111B. When the USART is in a mark state (logic high), IC111B is held reset and IC111A divides the 4800 Hz signal from the clock scaler by two. This is the 2400 Hz mark signal which is recorded on the tape. When the USART output goes low, the J and K inputs of IC111B go high and allow it to toggle. IC111A and IC111B then form a divide by four circuit and generate a 1200 Hz tone. The output from IC111A is filtered by R136 and C112. R137 and R138 form a divider for a low level microphone output signal.

### Motor Control

When a tape is to be read, the CPU sets the RTS bit in the command word going to the USART. This causes the  $\overline{\text{RTS}}$  pin on the USART to go low, which is inverted by IC112D and fed to relay driver transistor Q101. When Q101 conducts, it energizes relay RL102 which starts the tape player's motor. When the CPU is finished reading the tape, it resets the RTS bit in the command word and stops the motor.

When the CPU is ready to record data, it sends the first word to the USART, which causes the TxE (Transmitter Empty) pin to go low. This low is inverted by IC112B and drives Q102, energizing the relay and starting the recorder's motor. IC112C, which is also fed from Q102, then starts the 5-second timer. The output of IC112C had been low, keeping C111 discharged through D103. This forced the output of IC102B high to hold the  $\overline{\text{CTS}}$  (clear to send) input of the USART high. With  $\overline{\text{CTS}}$  high, the USART cannot send data.

Once the output of IC112C goes high, C111 starts charging through R132. After about five seconds, the voltage at pin 8 of IC102B reaches the voltage at pin 9 and the output will go low. This enables the USART to start data transmission. The delay allows the tape recorder to reach operating speed and provides a convenient gap on the tape for separating programs.

After the first word is transferred from the USART, the TxE pin may go high momentarily, showing that the USART is empty while a new word is being loaded. To prevent this pulse from affecting the motor control circuitry; R125, R126, and C109 filter the pulse out.

## USART

The USARTs (IC123 and IC124) are the heart of the serial channels. These devices perform the parallel-to-serial conversion between the parallel system bus and the serial data ports. They are software programmable and, as such, must be initialized before they can be used.

The USART communicates with the CPU through the bidirectional data bus which carries data, command, and status words. The serial data is transferred on the TxD (transmit data) and RxD (receive data) lines at the data rate selected by the TxC (transmit clock) and RxC (receive clock) lines, respectively. These clocks normally operate at 16 times the data rate and are obtained from the data rate scaler, IC114 and IC116. The serial data lines rest in the mark state, which is a logic high.

The status flags of the USARTs may be read by the CPU through the data bus and are also available at certain pins on the IC package. These flags are gated at IC128 and IC129, which are open collector gates, by the DTR bit from the USART. The outputs from these gates may be combined and patched to the interrupt bus for systems which require immediate attention to I/O requests. The DTR bit on the USART is software controlled and is used to selectively disable the interrupts for each channel.

## CLOCK AND DATA RATE SCALER

The data rate scaler provides the data clocks for the USARTs, and the audio tone for the tape interface modulator.

Inverters IC112E and IC112F are biased in their active regions and, with crystal Y101 and capacitor C113, form a 4 MHz oscillator. The oscillator signal is first divided by 13 in IC113, which produces 307 kHz at IC114 pin 2. Each of the four stages of IC114 then further divides the signal by two and produces four of the clock outputs. The 1200 baud output (IC114, pin 11) is fed to IC116 where further divisions by two give three more clock outputs. The 2400 baud output (IC114, pin 12) is fed to IC115 which divides the signal by 11. This asymmetrical signal is then fed to the divide-by-two section of IC116. This generates the 110 baud output which is also used as a calibration signal.

The following chart shows the frequencies available at the clock outputs.

DATA RATE	CLOCK FREQUENCY
9600	153.6 kHz
4800	76.8 kHz
2400	38.4 kHz
1200	19.2 kHz
600	9600 Hz
300	4800 Hz
150	2400 Hz
110	1745 Hz

## SERIAL I/O BUFFER

IC's 119 and 121 optically isolate the circuit board TTL levels from external levels or currents. This allows interfacing to current loops which are not referenced to the computer's ground.

Transmit data from USART IC124 is buffered by IC122C and applied to transistor Q105. Q105 drives the optical coupler LED inside IC119, and the light controls the photo transistor inside the coupler. When the photo transistor is off, Q104 provides a constant current to the base of Q103, which keeps Q103 turned on until the LED turns on the photo transistor. Then the drive current to Q103 is shunted and Q103 stops conducting.

Q103 acts as a switch that is controlled by the transmitted data. When not transmitting, the output of the USART is high (in a "mark" state) which causes Q103 to conduct. As data is transmitted, Q103 turns off and on corresponding to the spaces and marks. Diode D107 provides reverse voltage protection should the output leads be interchanged.

For a passive 20 milliampere current loop output, pins 7 and 8 of P102 are inserted in the loop with pin 8 to the more positive side. For an active loop (current supplied by the interface), current flows from pin 9, through R144, to the loop. The return side of the loop, pin 8, is switched to ground by Q103. For an RS-232 output driver, R144 and R145 form a pull-up to +18 volts while Q103 and R143 pull the output (pin 8) negative when Q103 conducts.

IC121 provides isolation for the input signal. D108 provides reverse voltage protection and R152 improves noise immunity by shunting low level current.

When current flows through the LED in IC121, the photo transistor turns on and causes pin 12 of IC122D to go low. IC122D inverts this signal and feeds it to the data input of the USART. IC122D also buffers any direct TTL inputs from pin 3 of P102.

When used as a passive input, R151 is jumpered out of the circuit and pins 5 and 6 of P102 are inserted in the loop with pin 6 to the more positive side. When used as an active input, R151 is again jumpered, but pin 6 is jumpered to ground. The loop is connected between pins 5 and 10, with the more positive side to pin 5. R143 provides a current source to the negative supply line from pin 10. When used as an RS-232 input, pin 6 is jumpered to ground and the signal is applied to pin 5. R151 provides current limiting for the LED input of IC121.

IC122A and B, and Q106 and Q107 provide buffering for the DTR and RTS command lines from the USART. These lines are software programmable and may be used for controlling the serial I/O device.

## PORT DECODER

The port decoder causes each I/O port to respond only to its particular port number. When the CPU addresses an I/O port, the port number is put out on the lower eight bits of the address bus. These lines are fed to IC125 and IC126 which may be programmed to respond when certain addresses are present. Due to the bus structure of the computer, the address (and data) lines go low when asserted.

The decoder has three sections; IC126A, IC125, and IC126B. These correspond to the three digits of the port number. IC126A decodes the most significant digit. Its selected output goes low and enables IC125 to decode the second digit. Then its selected output goes low and enables IC126B to decode the least significant digit. Notice that only even-numbered addresses are available from IC126B. This is because the USARTs require a pair of ports, one for control words and the other for data. The least significant bit of the address (A<sub>0</sub>) is used to switch the USART between these ports.

The selected output of IC126B goes low when it is enabled. This enables the USART through the Chip Select pin. The two USART chip select pins may be interchanged with Port Interchange switch SW101 if you want the console device to respond to the Load and Dump address. This is useful when using a teletype terminal's paper tape punch/reader.

The address decoder is active during memory references and the USARTs may be enabled. This has no effect, however, since the I/O read and write pulses would not be present.

## CONTROL LOGIC

The signals from the control bus are buffered by IC127. The Reset line goes low during "power up" and whenever the system is reset from the computer front panel. This signal is inverted by IC127E and resets the USARTs, IC123 and IC124. The least significant bit of the address, A<sub>0</sub>, is inverted and switches the USARTs between the command (A<sub>0</sub> Lo) and data (A<sub>0</sub> Hi) modes. The I/O write line (IOW) causes a word to be written into a USART if it is enabled. The I/O read line (IOR), in conjunction with the address decoder, causes a word from the selected USART to be placed on the local data bus.

Either output from the address decoder going low will cause the output of IC118D to go high. If the I/O read line is also high, the output of IC118C will go low and enable bus driver IC132, and disable bus receiver IC131. The system clock, Ø2, is inverted by IC127B and used as the high speed clock for the internal operation of the USARTs.

## DATA BUS BUFFERS

IC131 and IC132 form a bidirectional, tri-state, data bus buffer. If neither of the ports are being read, IC131 is enabled by the low on C<sub>E</sub>, and IC132 is disabled. This inverts the system data bus and puts it on the local data bus to the USARTs. Since IC132 is disabled, its outputs are in a high impedance state and have no effect.



When either USART is to be read, the output of IC118C goes low. This disables IC131 and enables IC132, which turns around the local data bus and transfers data from the selected USART to the system data bus.

### LOGIC PROBE

The inverting input (pin 4) of IC102C is used to check for TTL logic levels. The noninverting input (pin 5) is held at 1.2 volts by R159 and R161. Whenever the test signal is greater than 1.2 volts, the output of IC102C goes low and discharges C114. This causes the output of IC102D to go low and LED101 to turn on. When the

test input goes below 1.2 volts, the output of IC102C will go high and allow C114 to start charging. When the capacitor voltage reaches approximately 2.5 volts, the output of IC102D will go high and turn off the LED. The charging capacitor causes short input pulses to be stretched so they can be seen as the LED stays lit.

### POWER SUPPLY

Unregulated, positive 8-volts DC is supplied from the main Computer bus to the circuit board. IC133 then regulates it at +5 volts.

## SEMICONDUCTOR IDENTIFICATION CHARTS

### DIODES

COMPONENT	HEATH PART NUMBER	MAY BE REPLACED BY	IDENTIFICATION
D101, D102, D103, D105, D106, D107, D108	56-56	1N4149	
LED101	412-611		

### TRANSISTORS

COMPONENT	HEATH PART NUMBER	MAY BE REPLACED BY	IDENTIFICATION
Q101, Q102, Q105, Q106, Q107	417-821	MPSA06	
Q103	417-865	MPSA55	
Q104	417-897	SELECTED	

INTEGRATED CIRCUITS

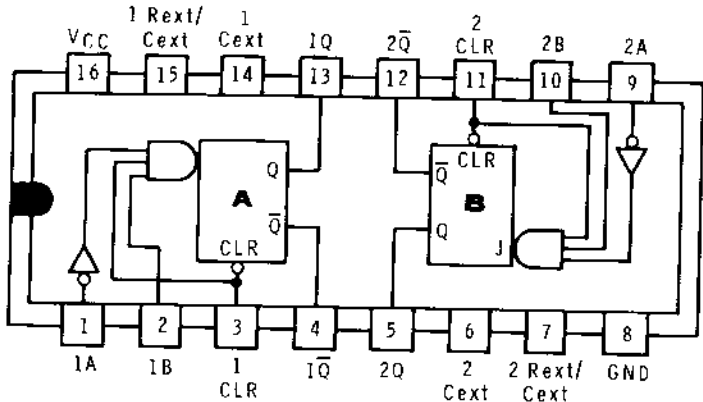
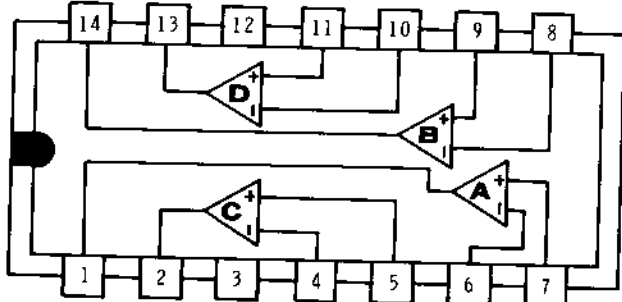
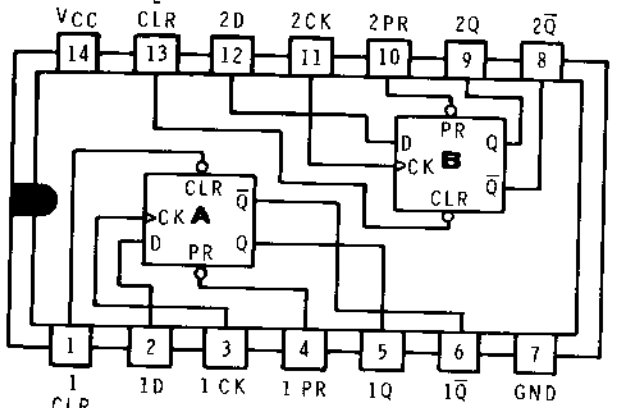
COMPONENT	HEATH PART NUMBER	MAY BE REPLACED BY	IDENTIFICATION
IC101, IC103	443-90	SN74123	
IC102	442-616	LM3302, LM2901, or $\mu$ A775	
IC104, IC105,	443-730	SN74LS74N	



COMPONENT	HEATH PART NUMBER	MAY BE REPLACED BY	IDENTIFICATION
IC106	442-647	CD4046	
IC107, IC115, IC116	443-640	SN7493N	



COMPONENT	HEATH PART NUMBER	MAY BE REPLACED BY	IDENTIFICATION
IC108, IC118, IC122	443-728	SN74LS00N	
IC111	443-828	SN74LS73N	
IC112	443-18	SN7404N	
IC127	443-858	SN74LS04N	

COMPONENT	HEATH PART NUMBER	MAY BE REPLACED BY	IDENTIFICATION
IC113, IC114	443-757	SN74LS161N	
IC117	443-45	SN7408	
IC119, IC121	443-808	4N26	

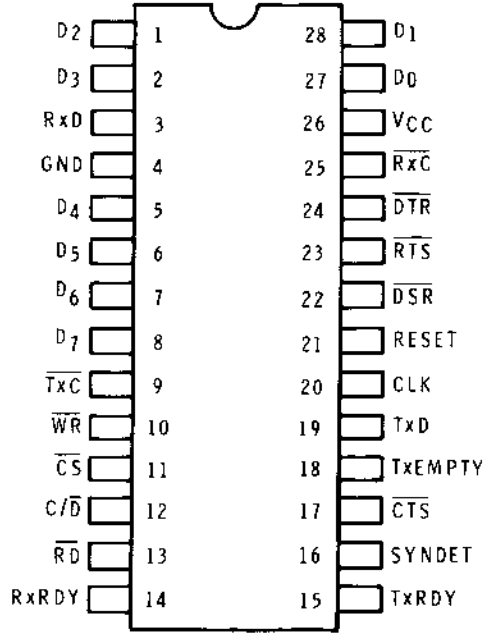
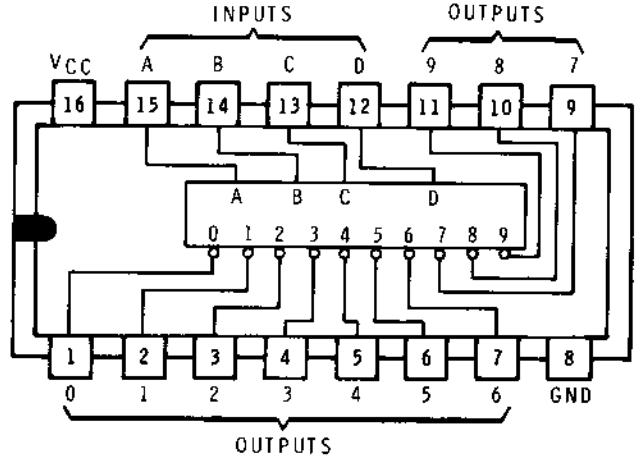
COMPONENT	HEATH PART NUMBER	MAY BE REPLACED BY	IDENTIFICATION
IC123, IC124	443-776	8251	 <p>Pinout diagram for IC123, IC124 (8251):</p> <ul style="list-style-type: none"> <li>Pin 1: D2</li> <li>Pin 2: D3</li> <li>Pin 3: RxD</li> <li>Pin 4: GND</li> <li>Pin 5: D4</li> <li>Pin 6: D5</li> <li>Pin 7: D6</li> <li>Pin 8: D7</li> <li>Pin 9: Tx̄C</li> <li>Pin 10: WR̄</li> <li>Pin 11: CS̄</li> <li>Pin 12: C/D̄</li> <li>Pin 13: RD̄</li> <li>Pin 14: RxDY</li> <li>Pin 15: TxRDY</li> <li>Pin 16: SYNDET</li> <li>Pin 17: CTS̄</li> <li>Pin 18: TxEMPTY</li> <li>Pin 19: Tx̄D</li> <li>Pin 20: CLK</li> <li>Pin 21: RESET</li> <li>Pin 22: DSR̄</li> <li>Pin 23: RTS̄</li> <li>Pin 24: DTR̄</li> <li>Pin 25: Rx̄C</li> <li>Pin 26: VCC</li> <li>Pin 27: D0</li> <li>Pin 28: D1</li> </ul>
IC125	443-53	SN7442	 <p>Pinout diagram for IC125 (SN7442):</p> <ul style="list-style-type: none"> <li>Pin 16: VCC</li> <li>Pin 15: A</li> <li>Pin 14: B</li> <li>Pin 13: C</li> <li>Pin 12: D</li> <li>Pin 11: 9</li> <li>Pin 10: 8</li> <li>Pin 9: 7</li> <li>Pin 8: 6</li> <li>Pin 7: 5</li> <li>Pin 6: 4</li> <li>Pin 5: 3</li> <li>Pin 4: 2</li> <li>Pin 3: 1</li> <li>Pin 2: 0</li> <li>Pin 1: 0</li> <li>Pin 0: GND</li> </ul> <p>Inputs: A, B, C, D (pins 15, 14, 13, 12)</p> <p>Outputs: 9, 8, 7, 6, 5, 4, 3, 2, 1, 0 (pins 11, 10, 9, 8, 7, 6, 5, 4, 3, 2, 1, 0)</p>

COMPONENT	HEATH PART NUMBER	MAY BE REPLACED BY	IDENTIFICATION
IC126	443-822	SN74LS139	
IC128, IC129	443-54	SN7403	
IC131, IC132	443-754	SN74LS240	

COMPONENT	HEATH PART NUMBER	MAY BE REPLACED BY	IDENTIFICATION
1C133	442-54	$\mu$ A7805	