

THE
KAYPRO
USER'S
GUIDE

© September 1983

Part Number 1100
Version 5 - Revision 1

COPYRIGHT AND TRADEMARK

© 1983 Kaypro Corporation. KAYPRO is a registered trademark of Kaypro Corporation.

DISCLAIMER Kaypro Corporation hereby disclaims any and all liability resulting from the failure of other manufacturers' software to be operative within and upon the KAYPRO computer, due to KAYPRO's inability to have tested each entry of software.

LIMITED WARRANTY Kaypro Corporation warrants each new instrument or computer against defects in material or workmanship for a period of ninety days from date of delivery to the original customer. Fuses are excluded from this warranty. This warranty is specifically limited to the replacement or repair of any such defects, without charge, when the complete instrument is returned to one of our authorized dealers or Kaypro Corporation, 533 Stevens Avenue, Solana Beach, California 92075, transportation charges prepaid.

This express warranty excludes all other warranties, express or implied, including, but not limited to, implied warranties of merchantability and fitness for purpose, and KAYPRO CORPORATION IS NOT LIABLE FOR A BREACH OF WARRANTY IN AN AMOUNT EXCEEDING THE PURCHASE PRICE OF THE GOODS. KAYPRO CORPORATION SHALL NOT BE LIABLE FOR INCIDENTAL OR CONSEQUENTIAL DAMAGES. No liability is assumed for damage due to accident, abuse, lack of reasonable care, or loss of parts.

REDIRECTION Please first direct all queries and problems to your dealer.

CONTENTS

MEET THE KAYPRO!

Meet the KAYPRO!	1
What you will need	2
Setting up your KAYPRO	3

WHAT YOU NEED TO KNOW

Keys on the left of the keyboard	10
Keys on the right of the keyboard	11
The keypad	12
The cursor and cursor keys	13
The big green screen	14
Memory	15
Storage of programs and information	16
Care of diskettes	17
Naming files	21
Cold boot and warm boot	23

STARTING THE COMPUTER

Starting the KAYPRO	25
Turning off the KAYPRO	27
Copying master diskettes	28
Formatting a diskette	30

USING UTILITY FILES

CP/M — the program which operates the KAYPRO	32
Using the file directory	34
Getting statistics about files on a diskette	35
Putting a file on the screen or on paper using CP/M	36
Copying files from one diskette to another using the PIP command	37
Erasing files	39
Renaming a file	40

TECHNICAL INFORMATION

Troubleshooting	41
Maintenance	44
Connecting a printer	45
Parallel printer	45
Serial printer	47
Serial printer port - RS232C	48
Serial port assignments	49
Baud rate table	49
I/O port addresses	50
Memory map of the KAYPRO computer	54
Control key and functions	55
Video command protocol	56
ASCII chart	57
Reconfiguring the keypad	59
Program to turn off the keyboard beeper	61
FCC Information	62
GLOSSARY	63
INDEX	67

MEET THE KAYPRO!

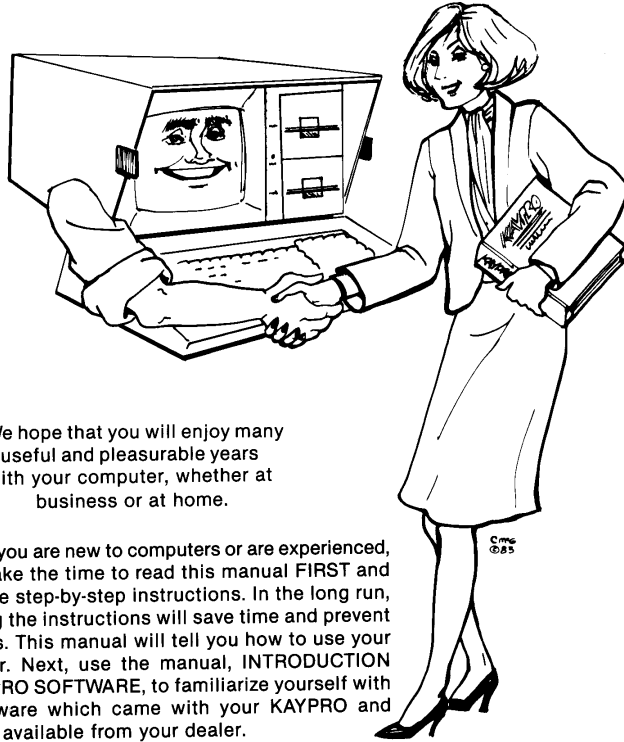

We hope that you will enjoy many useful and pleasurable years with your computer, whether at business or at home.

Whether you are new to computers or are experienced, please take the time to read this manual **FIRST** and follow the step-by-step instructions. In the long run, following the instructions will save time and prevent problems. This manual will tell you how to use your computer. Next, use the manual, **INTRODUCTION TO KAYPRO SOFTWARE**, to familiarize yourself with the software which came with your KAYPRO and which is available from your dealer.

Many of the terms used in this manual are explained in the glossary at the back.

WHAT YOU WILL NEED

Blank Diskettes

The KAYPRO II uses 5¼-inch SINGLE-sided, double- density, soft-sector floppy diskettes to store information.

The KAYPRO 4 uses 5¼-inch DOUBLE-sided, double- density, soft-sector floppy diskettes to store information.

You need enough blank diskettes to copy your master diskettes and as many others as you need to store information such as: text files, mailing lists, and programs which you write. If you value the information you'll be storing, don't buy low-quality diskettes.

Work Surface

You need a work surface about 25 inches high with leg room underneath.

Power Requirements

Power requirements for the KAYPRO are 115 to 125 VAC, 50 to 60 Hertz at 60 watts (normal house current). The outlet should be grounded. If you want to take your computer overseas, your dealer can switch the power supply to 220 VAC. For power requirements for peripherals, such as a printer, consult the owner's manual for the peripheral.

Optional Line Filter

If you have heavy machinery operating from the same power source, or if you experience frequent power shortages or surges, it may be advisable to use a line filter.

Optional Backup Power Source

To provide continuous power in case of a power outage, backup power sources are available from various manufacturers. Contact your dealer about this.

SETTING UP YOUR KAYPRO

When unpacking your KAYPRO, be sure to save the packing materials in case you want to ship it some day.

1. Set the KAYPRO on the work surface where you want the keyboard to be, because the keyboard is on the bottom. While it is in this position, look at the rear panel to locate the controls, switches, and ports.

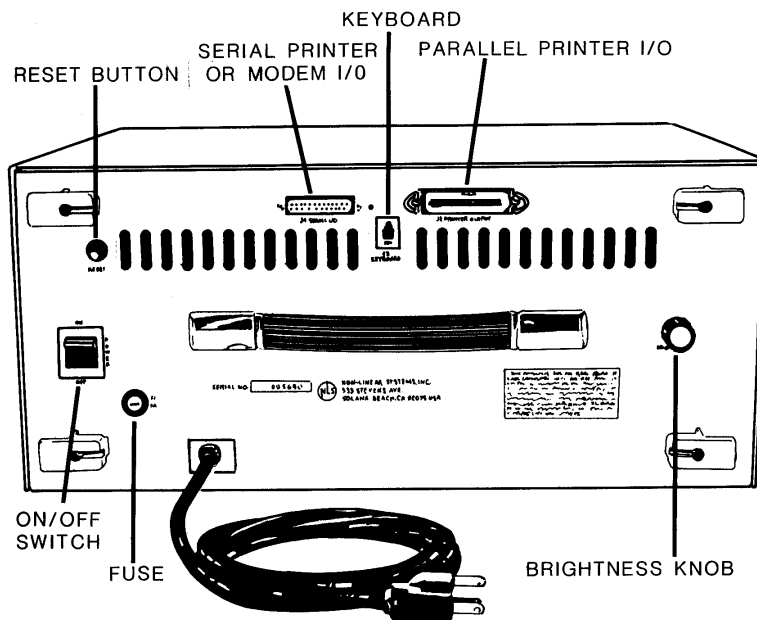

2. Then, turn the KAYPRO so the ventilated side faces away from your work position.
3. Unwind the AC line power cord, but DO NOT PLUG IT IN YET.
4. Push down the tops of the latches on both sides of the KAYPRO, and then pull out the lower parts of the latches to detach them from the keyboard.

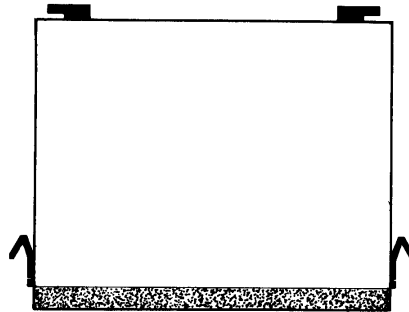
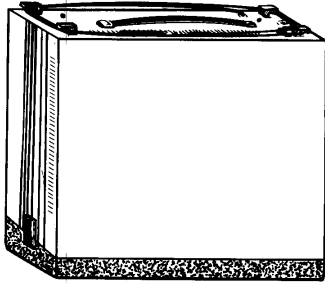

5. Carefully lift the computer off the keyboard, and lay it on the working surface with the large, ventilated surface down.
6. Place the keyboard where you can use it comfortably.
7. Lift the front of the computer, and GENTLY place the rubber feet on the back of the keyboard.

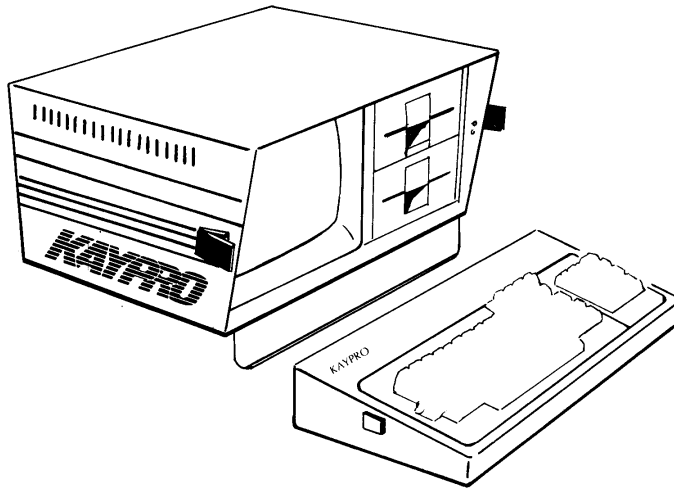

- 8 . Plug one end of the coiled cable into the J3 keyboard jack on the back of the computer. The clip on the plastic connector should be up.

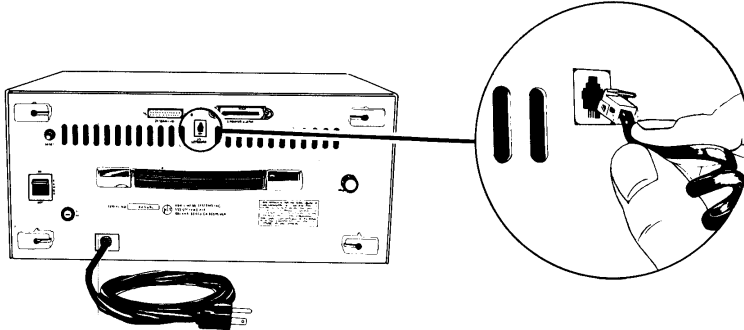

9. Plug the other end of the cable into the jack on the back of the keyboard. The clip on the plastic connector should be down.

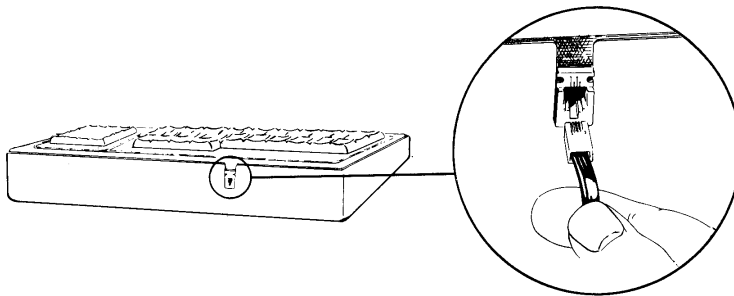

10. Remove the cardboard disk-drive protectors from each of the disk drives. If you close the computer to carry it, reinsert these protectors. A handy place to keep them is tucked under the handle on the back of the computer. If you ever ship your KAYPRO, be sure to place these protectors in the disk drives, or the drive warranty will be void.
11. Make sure the ON-OFF rocker-type switch on the back of the computer is turned OFF (down).
12. Then connect the computer to the power source.

Before you turn the computer ON, take the time to read the next section. It contains information regarding memory, the CP/M operating system, the screen, the cursor, and floppy diskettes.

BECOMING ACQUAINTED WITH YOUR COMPUTER

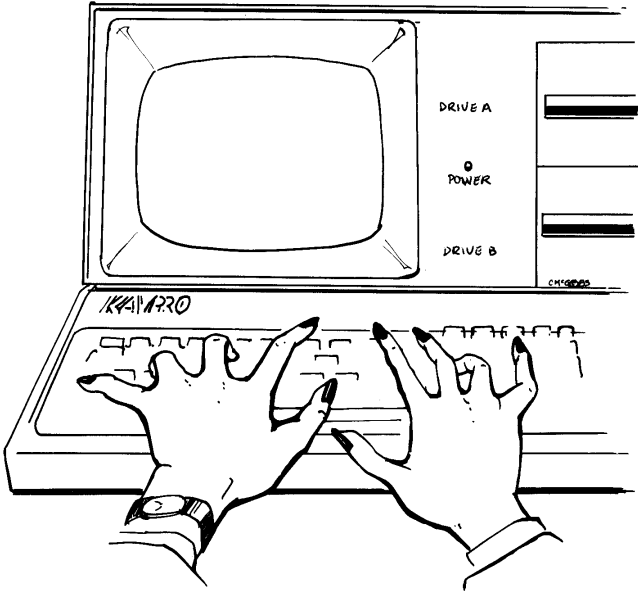

KEYS ON THE LEFT OF THE KEYBOARD

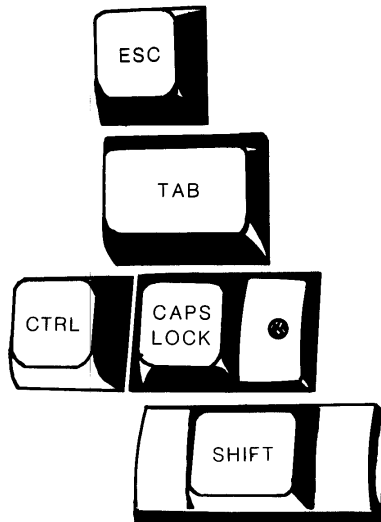

The ESCape key is used according to instructions.

The TAB key moves the cursor horizontally a set number of spaces and inserts those spaces, depending on the program in use.

The CONTROL key is used simultaneously with letter keys to do certain functions. Depress the CTRL key; then, while it is depressed, type the letter. Sometimes the control function will display as a ^ character followed by a second character.

The CAPS LOCK key puts alphabetic characters in upper case. Press once to activate it (the red light on the key goes on), and press again to deactivate it.

The SHIFT key is used simultaneously with letter keys to put alphabetic characters in upper case.

KEYS ON THE RIGHT OF THE KEYBOARD

The BACKSPACE key moves the cursor backward, sometimes deleting the character over which it moves, depending on the program being used.

The DELETE key echoes the previous character while deleting it. You will see this happen if you try to use the key to correct command lines. It has other functions, depending on the program being used. For instance, in word processing programs, it simply deletes the previous character, much like a self-correcting typewriter.

The RETURN key moves the cursor down a line and returns the cursor to the left of the screen. It also tells the computer to execute a command and has various other uses. <RET> and <CR> are computer symbols to indicate that you should press the return key.

The LINE FEED key moves the cursor down one line with no return to the left.

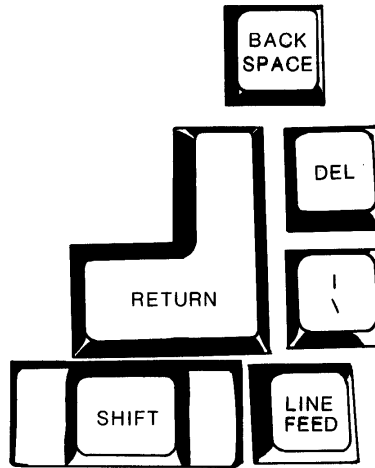

THE KEYPAD

To the right of the main keyboard are 14 keys in a numeric calculator-style layout.

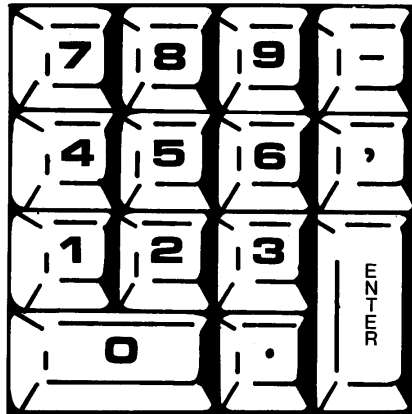

With the exception of a few control keys, such as CTRL, ESC, and RETURN, all of the keys, including the cursor movement keys, will automatically repeat when held down.

You can use the CONFIG program on the CP/M diskette to program the cursor keys and the keypad keys to act as any character or control key that you desire. Instructions for doing this are given later in this manual. Look in the index under "keypad, configuring".

THE CURSOR AND THE CURSOR KEYS

The cursor is a place marker to show where information can be entered. It is indicated by a flashing underscore. The next character you type will appear at this location.

When you are using certain programs, you can use the cursor keys to move the cursor freely in any direction on the screen:

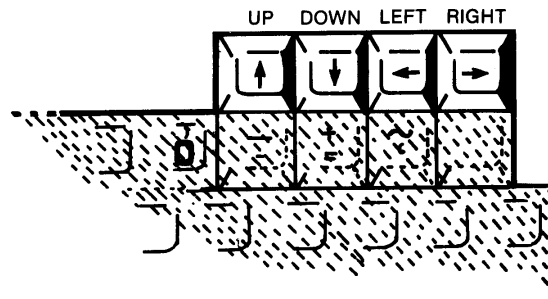

These keys will not function in this manner in CP/M.

THE BIG GREEN SCREEN

The video screen displays information communicated between you and the computer, such as characters typed on the keyboard, stored information, and prompts (requests for you to type information).

The screen holds 1,920 characters in 80 vertical columns and 24 horizontal lines.

You can adjust the brightness of the display by turning the brightness knob on the back panel.



MEMORY

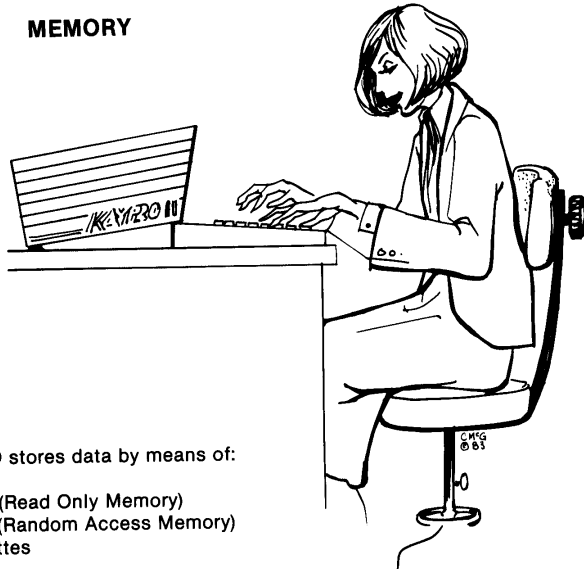

The KAYPRO stores data by means of:

- ROM (Read Only Memory)
- RAM (Random Access Memory)
- diskettes

ROM is the smallest portion of memory. ROM contains permanent programs and information most frequently used.

RAM holds 64 kilobytes (65,535 bytes) of information. RAM can be read from and written to. The data in RAM is lost when the computer is turned off, so any program or data stored in RAM has to be saved onto a diskette.

STORAGE OF PROGRAMS AND INFORMATION

Diskettes store information in the form of files. The number of files that can be stored on a diskette depends on how much information is in each file.

The KAYPRO II uses 5¼-inch SINGLE-sided, soft-sector diskettes, which can store 195K bytes. 4K bytes are reserved for the operating system and other essentials, leaving 191K bytes of space for approximately 60 typewritten pages of text for you to use to store information.

The KAYPRO 4 uses 5¼-inch DOUBLE-sided, soft-sector diskettes, which can store 390K bytes. 4K bytes are reserved for the operating system and other essentials, leaving 386K bytes of space for approximately 120 typewritten pages of text for you to use to store information.



CARE OF DISKETTES

Floppy diskettes store data on a magnetic surface that is vulnerable to damage which could result in the loss of data.

Here are a few simple guidelines for handling and using your diskettes to help prevent loss of data.



HANDLE DISKETTES WITH CARE: Do not flex or bend diskettes. Do not touch the brown, exposed portions of the diskettes, as chemicals or oils on the fingers can damage stored data.

KEEP DISKETTES COVERED: Keep diskettes in their protective covers when not in use.

STORE DISKETTES SAFELY: Store diskettes in a container or file in a clean, dry, cool place away from magnetic fields, away from the computer, telephone lines, etc. Do not place diskettes on top of the computer.

POWER: Do not put the diskettes in the drives until the power is turned ON. Always remove the diskettes before turning OFF the power.

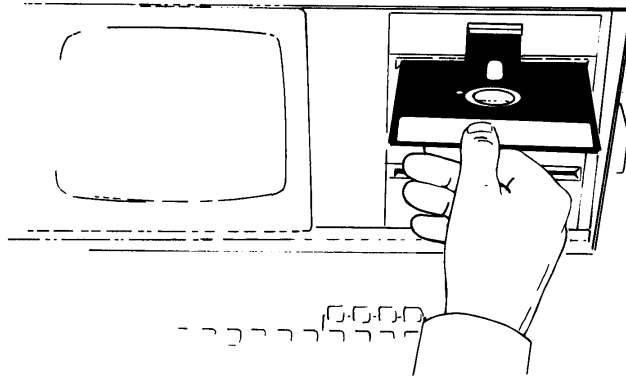

INSERT DISKETTES CAREFULLY: When inserting diskettes into the drives, hold them at the label edge with the label up and the seam side down. No force is necessary to insert them. Push down on the door until it clicks.

RESET THE COMPUTER AFTER CHANGING DISKETTES: When the drive door is closed after inserting a diskette, the information on that diskette is loaded into the computer and stays there until the computer is reset or turned off — even though the diskette is removed. If you remove one diskette and insert another without resetting the computer, the information from the newly-inserted diskette will load, but there will be problems. So, after changing diskettes, ALWAYS reset the computer by either pushing the reset button on the back panel or simultaneously pressing the CTRL key and the C key.

TO REMOVE A DISKETTE: Open the drive door by pushing in at the top of the drive door. Gently pull the diskette from the opening.

STORE INFORMATION FREQUENTLY: Save information as you create it — about two to four times an hour — and store your work whenever you leave the computer, even briefly. The procedure for storing information depends on the program being used.

MAKE BACKUP COPIES: Make working copies of your master diskettes, following the instructions given in this User's Guide. Then put your master diskettes away in a safe place. Use your working copies for everyday use.

Make backup copies of any diskettes you make to ensure that, if one is lost or damaged, you will still have a copy.

LABEL DISKS CAREFULLY: Immediately label and date all diskettes which contain programs or data. Use the KAYPRO labels provided to identify your working copy diskettes. Use plain, "press-apply" labels to identify the files on other diskettes.

When labeling diskettes, write the label first, and then apply it to your diskette. If you must write on a label which is already on a diskette, use only a soft, felt-tip pen, as a ballpoint pen can damage a diskette.

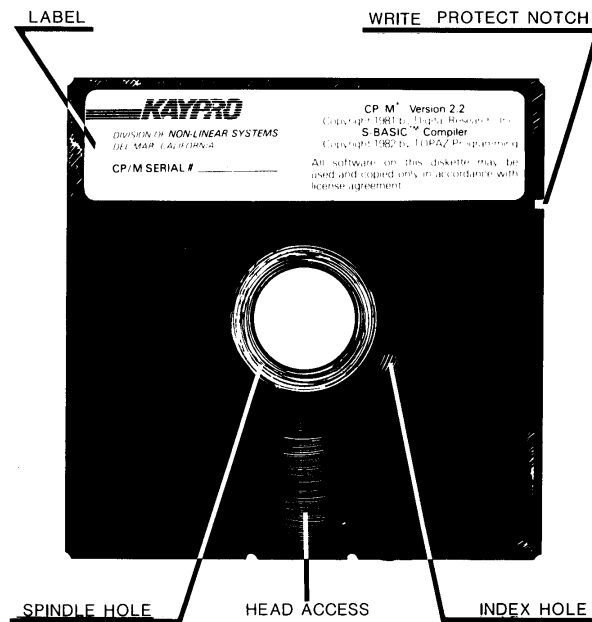

WRITE-PROTECT NOTCH: A write-protect notch allows information to be written to or read from a diskette.

- If this notch is covered, information can only be read FROM the diskette.
An example is the master diskettes for the KAYPRO programs. They have no write-protect notches so that you can't inadvertently write onto them.
- If you want to write information to a diskette, don't cover its write-protect notch.
- When you want to ensure that you do not accidentally erase stored information, cover the write-protect notch with the tabs provided with new diskettes.

NAMING FILES

Files must be named according to established practices, and the file names must be typed correctly.

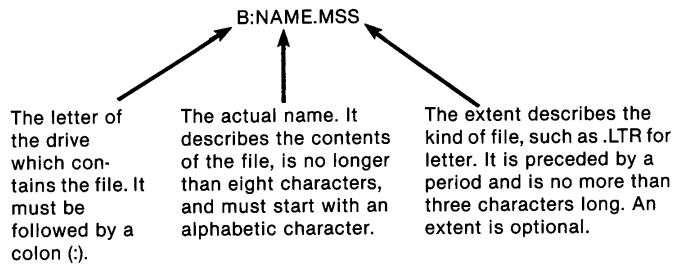

There are some characters that you must NOT use in a file name:

< > () \ / ; : = ? * [] . , _ % |

We recommend that you use only the letters A to Z and the number 0 to 9, as some programs may have problems with other characters.

BE SURE to type the letter of the drive you want before the file name; otherwise the computer will stay in the current drive.

When creating a file, use upper case letters. However, when accessing programs, you may type file names and drive names in lower case.

In computer books, the generic name for a file is <filename>. When you see this,

substitute the name of the file you want to use, but do not type the angle brackets < >. Include the file type, if there is one.

COLD BOOT AND WARM BOOT

Cold boot and warm boot are computer slang for two processes which are also called cold start and warm start.

COLD BOOT: This is the process which starts the computer when you turn it on. When you see the A> prompt on the screen, the cold boot has been accomplished, and the computer is ready for a program to be implemented.

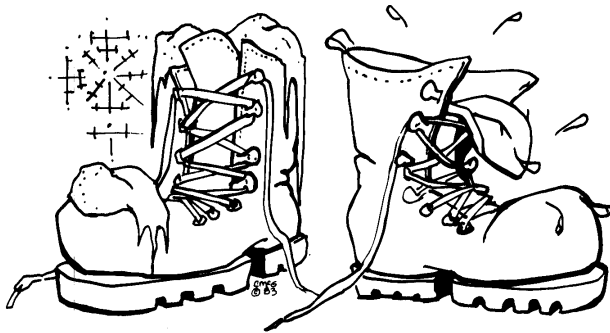

WARM BOOT: This is the process which restarts the computer while it is turned on. When it is restarted, the memory is cleared. Some programs do a warm boot for you when the program is finished, and you will see the message:

Warm Boot

A>

When you see the A> prompt, CP/M is waiting for you to enter the name of a program you want to run or to give it a warm boot instruction.

To give the warm boot instruction, press the CTRL key and the C key at the same time.

Warm boot the computer whenever you change disks, so that CP/M can remap the diskette into memory. Otherwise, it will give a BDOS error message.

Some programs will keep track when you change diskettes, but, generally, IT IS GOOD TO FORM THE HABIT OF DOING A WARM BOOT WHENEVER YOU CHANGE DISKETTES.

Strange things may happen — you may do something that the program/computer doesn't expect, or there may be a "bug" (a hole in the logic of a program). Do NOT pull the plug or turn off the machine, as doing this can cause problems with the diskettes as well as destroy information which is in the machine at the time. In such circumstances, push the reset button on the back of the computer. This will destroy information which is in the computer, but will not affect the information which has been saved on the diskettes.

STARTING THE KAYPRO

1. Turn on the computer, using the power switch on the back panel. The power light and the drive A light will illuminate. The light for drive A will remain lighted unless you give a command for the computer to go to drive B.
2. If, after a moment, there is nothing on the screen, use the brightness control knob on the back panel to adjust the brightness.

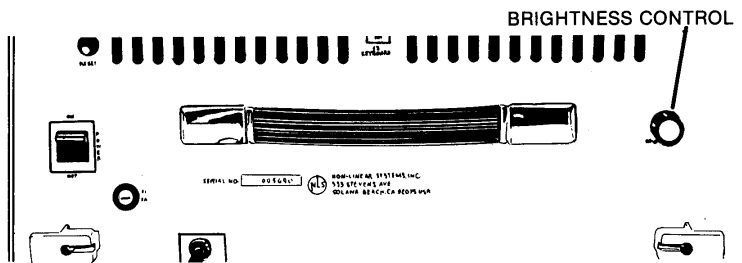

3. **IMPORTANT!** You cannot use the diskettes which came with your KAYPRO as they are; you need to copy these master diskettes. Follow the instructions given for Copying Your Master Diskettes.

4. As a general rule, the working copies of program diskettes go in drive A, and diskettes for data go in drive B.
5. When a program diskette is put in drive A, an A> prompt will display. This is the Console Command Program (CCP) prompt. You need to enter the information necessary to access the program; this information can be found in the appropriate manual for the program.

INDICATOR LIGHTS

POWER ON

Small, red light on front panel beside disk drives tells you that the power is ON.

DISK DRIVE INDICATOR LIGHTS

Small, red lights next to the door of each disk drive tell you which drive was selected last.

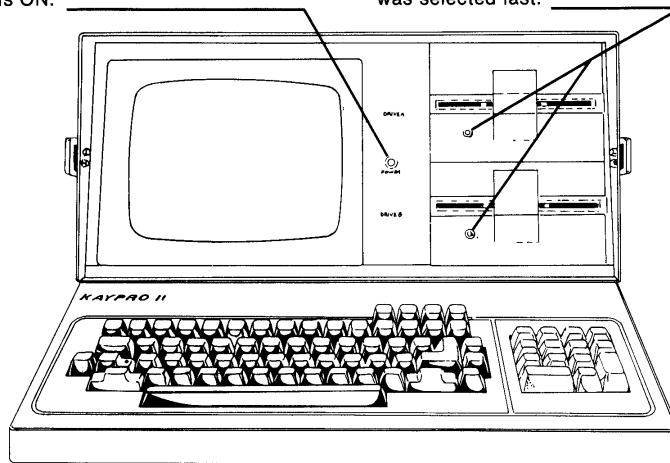

TURNING OFF THE KAYPRO

1. Be sure the file on which you are working is closed, according to the instructions in the manual for the program you are using.
2. When you see the CCP prompt, A>, remove the diskettes.
3. Turn off the computer, using the power switch on the back panel.

COPYING MASTER DISKETTES

Before you can use the software which came with your KAYPRO, you must copy each of the master diskettes.

The general process is the same every time you copy a diskette.

The COPY program is on the CP/M diskette. To use it:

1. Turn on the KAYPRO, using the power switch on the back panel of the computer.
2. Insert the CP/M diskette into drive A with the label facing up.
3. Close the drive door, and wait until the display shows the CP/M version number and the A> prompt.
4. To run the copy program, type: COPY
Press the RETURN key.
5. Put a new, empty diskette into drive B with the write-protect notch at the left.
6. When the main menu appears, choose the COPY option by typing: c
7. When you have read the message on the screen, remove the CP/M diskette from drive A (unless you are copying the CP/M diskette itself).
8. Insert the diskette that you want to copy into drive A.
9. To start the copying process, press the RETURN key.

The track numbers will display as they are being copied (00 through 39 on the KAYPRO II and 00 through 79 on the KAYPRO 4).

When the last track has been copied, there will appear a list of programs which are on the new diskette.

- If you do not want the menu of a program to automatically appear each time you insert a program diskette, press RETURN.
- If the diskette you are copying does not contain a program, press RETURN.

CP/M will be written to the disk, and the program will return to the main menu.

11. Remove the diskette from drive A.
12. Remove the new working copy from drive B.
13. Label it with the appropriate sticker provided in the software package, or make a label if you are copying a diskette other than a master diskette.
14. To make working copies of all your master diskettes, put the next diskette you wish to copy into drive A, and go back to step 5 to repeat the procedure until all the working copies of the master diskettes are made.
15. Store the master diskettes in a safe place to be used if you have to copy them again.

FORMATTING A DISKETTE

Formatting prepares a new diskette so that information can be stored on it. It is good to format all new diskettes as soon as you buy them, so that you will have them ready when you need them. During the copy process described previously, the formatting was done automatically.

When you format a disk, it is magnetically imprinted with 40 circular tracks, each track having 10 sectors.

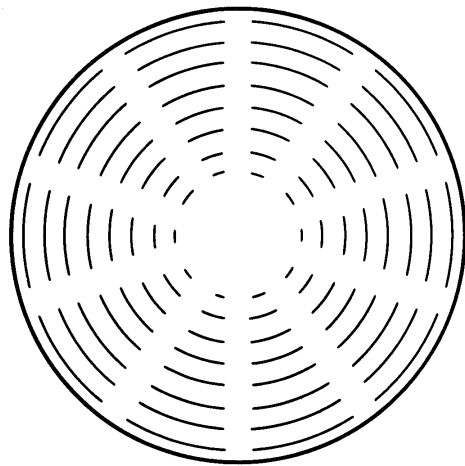

To format a diskette, use the BLANK option from the copy program. To do this:

1. Turn on or reset the computer.
2. Insert the working copy of your CP/M diskette in drive A.
3. Type: COPY
Press the RETURN key.
4. When the main menu appears, choose the BLANK option by typing: B
5. Read the message on the screen, and insert a new diskette into drive B.
6. Press the RETURN key.
7. You will see the formatting track numbers (00 through 39). When the last track is formatted, CP/M will be written to the disk, and the main menu will appear again. To exit, type: E

The diskette in drive B is now ready to store information.

CP/M — THE PROGRAM WHICH OPERATES THE KAYPRO

Your KAYPRO computer uses the CP/M (Control Program for Microprocessors) operating system. Most CP/M functions operate without your being aware of them, but a few utility files can be used under your control.

Three important “automatic” components of CP/M are:

BDOS, the Basic Disk Operating System, which handles files on diskettes;

BIOS, the Basic Input/Output System, which communicates with printers and other peripheral devices; and

CCP, the Console Command Program, which communicates between you, the user at the keyboard, and the internal processing of the computer.

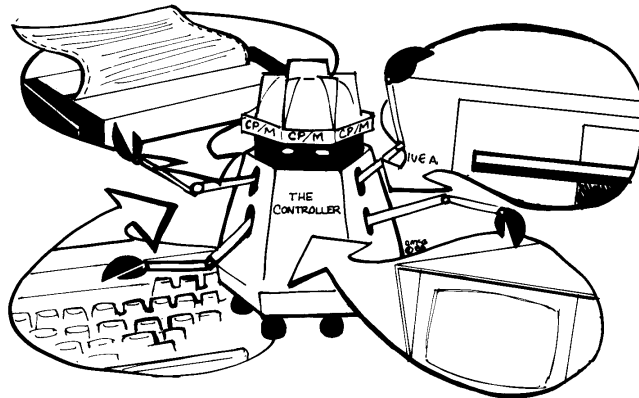

At your command, the CP/M does useful functions by means of "utility" programs. After you have learned to start and stop the KAYPRO, you can get an idea of what is available by viewing the KAYPRO.LRN file. Although this program was originally written for the KAYPRO II, the information is also useful for the KAYPRO 4. To read this file:

1. Turn on or reset the computer.
2. Put the working copy of the Perfect Writer EDIT DISK in drive A.
3. Put the working copy of the Perfect Writer LESSONS DISK in drive B.
4. After the A> prompt, type: PW B:KAYPRO.LRN
Press RETURN.

You will get some useful information from viewing this file. On the following pages are instructions for using the CP/M utility files.

USING THE FILE DIRECTORY

To list the files which are on a diskette, at the A> prompt, type: DIR
Press RETURN.

GETTING STATISTICS ABOUT FILES ON A DISKETTE

The STAT command provides STATistics about the space used and the space available on a disk.

The prompt, A> or B>, indicates the currently-logged disk drive. This is the disk drive on which the computer automatically looks for files if the drive name (A: or B:) isn't specified.

If the currently-logged drive (the one with the light on) is A, then the command:

STAT will show how much space is available for use on the diskette in drive A.

STAT B: will show how much space is available for use on the diskette in drive B.

STAT *.* will show how much space is used by each file on the diskette in drive A, as well as how much space is left.

STAT B:*.* will show how much space is used by each file on the diskette in drive B, as well as how much space is left.

You can change the currently-logged disk drive to drive B. After the A> prompt, type: B:

Press RETURN, and you will see the prompt, B>.
Now if you type: STAT

you'll see the STAT of the disk in drive B.

To get back to drive A, type: A:
Press RETURN.

PUTTING A FILE ON THE SCREEN OR ON PAPER USING CP/M

If you want to quickly check the contents of a document file:

1. Turn on or reset the computer.
2. Insert into drive A the diskette with the file that you want to check.
3. Type: type
4. Leave a space; then type the name of the file, including the file type, like this:

A>type <filename.ext>

5. Press RETURN.
6. The contents of the file will quickly scroll. To stop the scrolling, enter the command: CTRL—S
7. To restart the scrolling, again enter the command: CTRL—S

If you want to print the contents of a document file without using a word processing system:

1. Turn on or reset the computer.
2. Insert into drive A the diskette containing the file that you want to print.
3. Ready your printer.
4. Enter the command: CTRL—P
5. At the A> prompt, type: type
6. Leave a space; then type the letter of the drive containing the file, a colon (:), and the name of the file, as above.
7. Press RETURN. The file will print.

COPYING FILES FROM ONE DISK TO ANOTHER USING THE PIP COMMAND

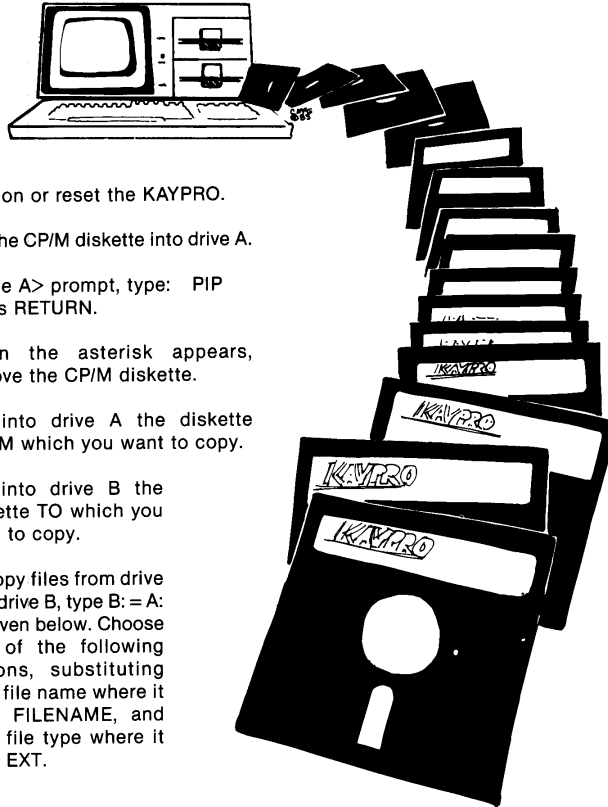

1. Turn on or reset the KAYPRO.
2. Put the CP/M diskette into drive A.
3. At the A> prompt, type: PIP
Press RETURN.
4. When the asterisk appears,
remove the CP/M diskette.
5. Put into drive A the diskette
FROM which you want to copy.
6. Put into drive B the
diskette TO which you
want to copy.
7. To copy files from drive
A to drive B, type B: = A:
as given below. Choose
one of the following
options, substituting
your file name where it
says FILENAME, and
your file type where it
says EXT.

To copy ONE file, type:

B: = A:FILENAME.EXT[OV]

To copy ALL the files which are on the diskette, type a *.* ("wild card"):

B: = A:*. *[OV]

To copy all the files which have the same EXTENT, type a *. and the particular extent — for example:

B: = A:*.LTR[OV]

8. When the files are finished copying, stop the PIP program by pressing RETURN.

ERASING FILES

You can erase files from the directory of a diskette in one of several ways.

1. Turn on or reset the computer.
2. To erase a file from a diskette in the currently-logged drive, use one of the following ERASE commands. To erase:

a file by its full name	ERA X.Y
all files with a certain file name	ERA X.*
all files with a certain file type	ERA *.LTR
all files on the current diskette (The question will appear:	ERA *.*

ALL FILES (Y/N)?

If you want ALL your files erased, answer y; if you don't want all your files erased, answer n.) *Be careful with this command!*

3. To erase a file from a diskette in the other drive, use the above commands, but precede the file name with the letter of the other drive followed by a colon. Example: ERA B:X.Y

RENAMING A FILE

To RENAME a file on a diskette in drive A, after the A> prompt:

To change file:	Type:
OLDNAME.DOC	REN NEWNAME.DOC = OLDNAME.DOC
to	
NEWNAME.DOC	

If the file to be renamed is on a diskette in the drive B, then precede the file name with: B:

TECHNICAL INFORMATION

TROUBLESHOOTING

If you have difficulties in operating your KAYPRO, PLEASE check the following list of symptoms and remedies before calling your dealer. Of course, when programs don't do what you expect, read the manual for that program.

If the following quick checks don't fix the problem, contact your dealer for assistance with both the operation of your software and the service needed for your KAYPRO.

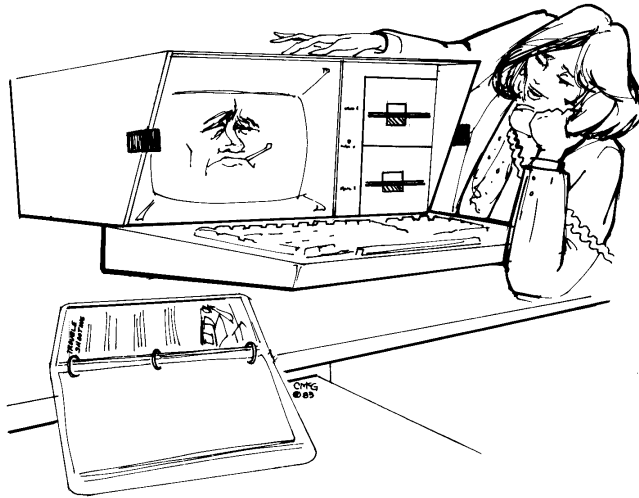

SYMPTOM: Programs won't load or execute.

PROBABLE CAUSES AND REMEDIES:

1. No AC power. Be sure that the power cord is plugged in. Check the power switch and any switches controlling the wall outlet.
2. No video display. Adjust the brightness control on the rear panel.
3. Disk drive door not closed properly.
4. Diskette in drive doesn't contain CP/M. Put the CP/M diskette into drive A and the diskette which isn't loading into drive B. Type: SYSGEN
Follow the prompts.
5. Diskette isn't the one expected by the operating program.
6. Diskette isn't in the drive correctly (label side should be up, seam side down, and write protect notch at left).
7. Diskette has been damaged. Try making another copy from your master.
8. Incorrect response to a prompt or invalid menu selection; check for error message from program.
9. You're asking the program to do something it can't. When all else fails, read your manual.

SYMPTOM: Computer unexpectedly ignores keyboard entries. It operates all right after pressing the reset button on the back panel.

PROBABLE CAUSES AND REMEDIES:

1. Disconnect and reconnect the coiled cord which attaches the keyboard to the computer.
2. Fluctuations in the AC power line. Use another outlet or an External Power Conditioner. Some battery backup units will filter out noise from heavy electrical machinery as well as cover for temporary "brownouts."
3. External peripheral devices or their connection cables may be at fault. Try operation without peripheral or with different cable to isolate the problem.
4. Damaged or faulty disk. Try another copy of your master diskette.
5. Incorrect instruction sequence. Check the appropriate manual to insure that you are using the correct operations and sequence.

MAINTENANCE

Because of the generally high reliability of modern, solid-state components, with normal use your computer should need very little maintenance or service.

It is important to keep the computer and diskettes dust-free. The computer itself can be cleaned with a damp, lint-free cloth. A mild kitchen detergent can be used, if necessary.

Care for peripheral devices, such as printers, should be covered in the manual that came with the device.

CONNECTING A PRINTER

Parallel Printer

Your KAYPRO computer comes equipped with a Centronics-type connector on the back panel, labeled: J2 PRINTER OUTPUT. If you have a printer with a similar 36-pin connector, then all you need is a standard parallel printer cable (available from your dealer) to connect the two units. If you have a non-standard connector on your printer or cannot find a suitable cable already assembled, then the following pin assignments should prove useful to the person who fabricates your cable.

1	STROBE	---->	A negative going signal to printer which indicates that the data being sent is valid.
2	DATA 1	---->	
3	" 2	---->	
4	" 3	---->	
5	" 4	---->	Data lines to printer.
6	" 5	---->	
7	" 6	---->	
8	" 7	---->	
9	" 8	---->	
10	Not connected		
11	BUSY	---->	The KAYPRO expects a low signal on this line from the printer to indicate readiness to receive a character. A high signal indicates that the printer is BUSY, and the KAYPRO should not send.

12, 13, 14, 15,
18, 31, 32, 34, 35, 36

Not connected

16, 17
19 - 30, 33

Ground

The following is an illustration of the pin assignments on the Centronics-type connector on the back panel.

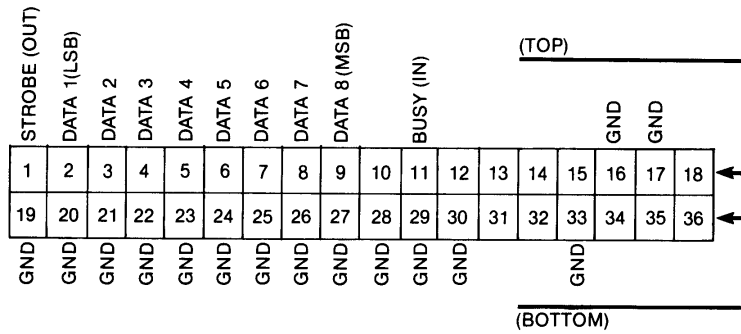

Note that the BUSY line is read by the KAYPRO as ACTIVE when left disconnected. If you tell your computer to print something when there is no printer there, your computer will sit patiently and wait for a printer to say that it's ready for data. And wait and wait and... Press the reset button on the back panel.

Serial Printer

Your KAYPRO was designed to be as easy to use as possible. The standard KAYPRO expanded system consists of your computer connected to a standard parallel printer via the parallel connector, J2, and to a modem via the RS-232C serial connector, J4. However, if you have a serial printer, you will need to adapt the serial interface for your printer.

The following information is provided to aid such modifications. But please note that Non-Linear Systems and Kaypro Computers make no guarantees about the suitability of a given serial printer for use with the KAYPRO's RS-232C serial interface. The reasons for some of the difficulties are given here, but before you purchase any serial printer, insist upon a demonstration of its operation.

There are three things you must do if you are to use a serial printer with the KAYPRO computer:

1. You must tell CP/M to redirect the printer output to the serial interface. Use STAT to change the physical assignment like this: A>STAT LST: = TTY:

You can make the change from a parallel printer (LPT:) to serial (TTY:) permanent on some of your diskettes by using the CONFIG program on your CP/M S-BASIC diskette.

2. You should make sure that the line being used by your computer for data transmission (pin 2 of connector J4) is connected to the printer's data reception pin (this is usually, but not always, pin 3 of the printer connector).
3. The remaining task is to take care of the hand-shaking signal lines. You can strap the signals so that they are always true (i.e., connect pins 8 and 5 of connector J4 to pin 6). The potential problem with defeating the handshaking lines in this manner is that you have to limit your baud rate to avoid overwriting the printer's internal buffer. For example, if you leave the KAYPRO's baud rate at 300 baud, your printer must be able to print at least 30 characters per second.

If you have problems with overwriting the buffer in your serial printer, you will have to implement some handshaking to correct the problem. The KAYPRO uses pin 5 (CLEAR TO SEND, see the following figure) as an indicator of printer readiness. For proper handshaking, the serial printer must produce a "not busy" signal for pin 5 that is high when the printer can accept data. Details of the handshaking your printer requires should be in its owner's manual.

KAYPRO SERIAL PRINTER PORT RS-232C

Note that the serial printer port on the KAYPRO II and 4 is wired as DTE, Data Terminal Equipment.

Pin assignments for the SERIAL PRINTER PORT (DTE)

- Pin 1 — Chassis ground
- Pin 2 — Transmit Data — to computer
- Pin 3 — Receive Data — from computer
- Pin 4 — Request to send
- Pin 5 — Clear to send
- Pin 6 — Data set ready
- Pin 7 — Signal ground
- Pin 8 — Data Carrier Detect
- Pin 20 — Data Terminal Ready

SERIAL PORT ASSIGNMENTS

For Modem (serial channel A):

PORT 4 is the Z-80 SIO data port. PORT 6 is the Z-80 SIO control and status port.

Received character available is obtained by testing bit 0 of the status port; Transmit Buffer Empty is obtained by testing bit 2 of the status port. Other details can be found in the Z-80 documentation available from Zilog.

The serial output is an 8-bit word with one start, one stop, and no parity.

Baud Rate Table

HEX #	Baud Rate
0	50
1	75
2	110
3	134.5
4	150
5	300
6	600
7	1200
8	1800
9	2000
A	2400
B	3600
C	4800
D	7200
E	9600
F	19200

Note: The default baud rate will be 300 baud when the KAYPRO is first turned on or when the reset button is pressed unless you change it with the CONFIG program on the CP/M S-BASIC diskette.

I/O PORT ADDRESSES

Port #	Use and/or assignment
00H	Baud rate. (Write only) Writing a number between 0 and F to this port will set the RS-232C baud rate.
04H	RS-232C Serial Data. (R/W) Data register of the Z-80 SIO
05H	Keyboard Data. (R/W) Eight-bit data from detachable keyboard. See the following S-BASIC program for an example of writing to this port.
06H	RS-232C Status. (R/W) Control/status port for the Z-80 SIO. See Zilog and Mostek Microcomputer Data Books.
08H	Printer Port. (Write only) Eight-bit data to parallel printer connector
1CH	System Port. (R/W) This port is used for system control. The various bits are used for memory bank selection, disk drive control, and printer handshaking.

SYSTEM PORT & I/O SELECT

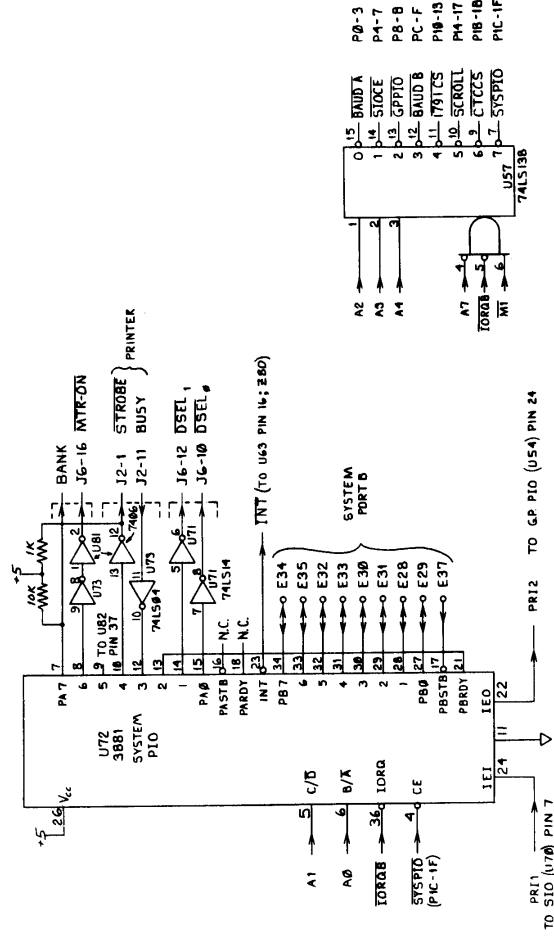

SERIAL PORT

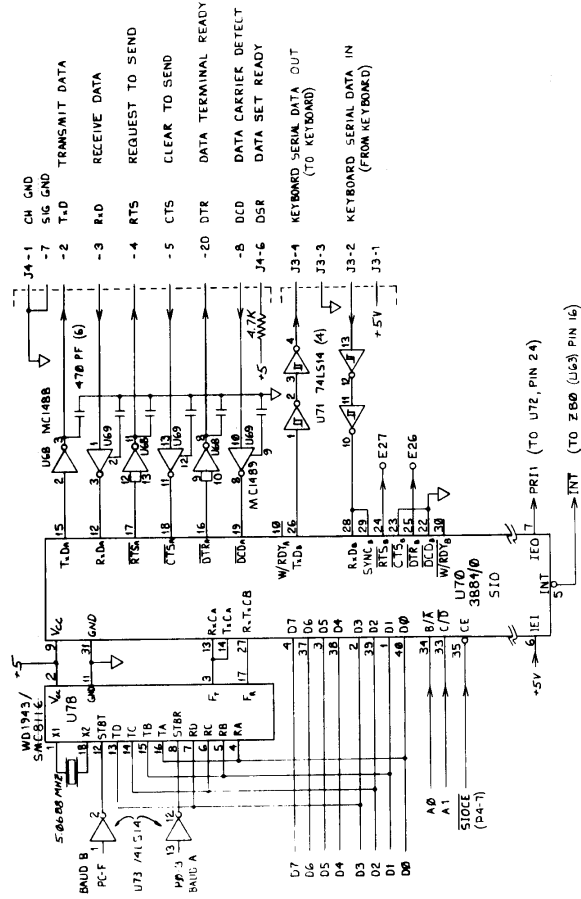

MEMORY MAP OF THE KAYPRO COMPUTER

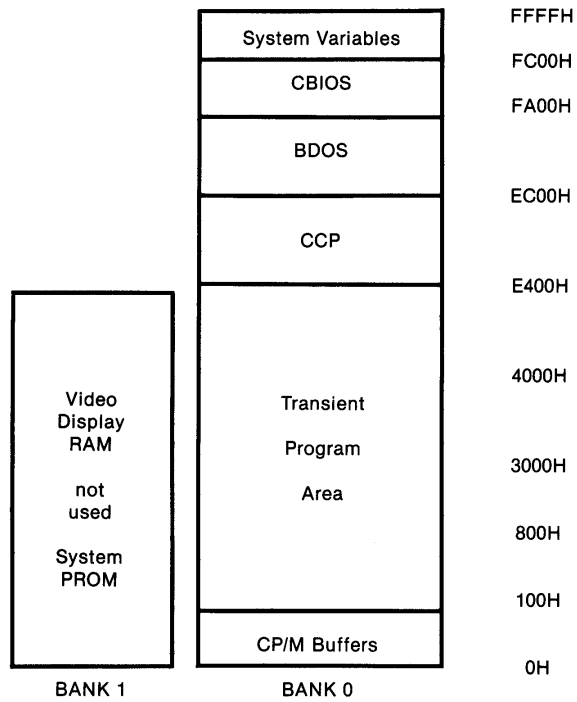

Please note that only the lowest 16 Kbytes of memory will change with the bank select bit; addresses above 3FFF hexadecimal are always available for either bank.

CONTROL KEY AND FUNCTIONS

The control key (CTRL) is used with other keys to control functions.

To use it, press the control key simultaneously with other keys; for some functions, you must then press the RETURN key. For some functions, there will be no visible indication. For other functions, a character will appear on the display screen as two characters side by side — the ^ character followed by a second character. For example, ^H (called CTRL-H) represents a backspace.

The same control command can have different functions in different programs. Consult the appropriate software manual to determine which control functions are to be used.

Common control functions in CP/M programs:

- CTRL-C CP/M system reboot (warm start)
- CTRL-E Physical end of line: carriage is returned, but line is not sent until RETURN key is depressed
- CTRL-P Copies all subsequent console output to the currently assigned list device (e.g., a printer) and the console device until the next CTRL-P is typed
- CTRL-R Retypes current command line: types a "clean line" following character deletion with rubouts
- CTRL-S Stops the console output temporarily. To restart, press any key.
- CTRL-U Cancels the entire line typed at the console and moves the cursor to new line
- CTRL-X Deletes the current line and returns cursor to the beginning of the same line
- CTRL-Z End input from console (used in PIP and ED)

VIDEO COMMAND PROTOCOL FOR KAYPRO II AND KAYPRO 4

The KAYPRO video section was designed to imitate most of the control sequences of a Lear-Siegler ADM-3A terminal. For most commercial software, this means you can "install" or customize the display characteristics by choosing ADM-3A from the menu.

For custom software or those instances where there is no choice of "ADM-3A" on the menu, the complete command protocol for the KAYPRO is:

Control Characters

Action	Dec	Hex
Ring Bell	07	07
Cursor left (non-destructive)	08	08
Cursor Right	12	0C
Cursor Down	10	0A
Cursor Up	11	0B
Erase to end of screen	23	17
Erase to end of line	24	18
Clear screen, home cursor	26	1A
Home cursor	30	1E

ESCape Sequences

Insert line	ESCape,R
Delete line	ESCape,E
Cursor address	ESCape, = ,row + 32,col + 32

Please note that, while the normal ASCII-printable characters are displayed on the screen, the operation of control codes not documented above is subject to change and may not be what your software expects. As an example, the NULL character (0H) will be displayed on the screen as an accent grave (`).

ASCII CHART

Dec	Hex	Char	Dec	Hex	Char	Dec	Hex	Char	Dec	Hex	Char
0	00	NUL or ^@	32	20	Space	64	40	@	96	60	`
1	01	SOH or ^A	33	21	!	65	41	A	97	61	a
2	02	STX or ^B	34	22	"	66	42	B	98	62	b
3	03	ETX or ^C	35	23	#	67	43	C	99	63	c
4	04	EOT or ^D	36	24	\$	68	44	D	100	64	d
5	05	ENQ or ^E	37	25	%	69	45	E	101	65	e
6	06	ACK or ^F	38	26	&	70	46	F	102	66	f
7	07	BEL or ^G	39	27	'	71	47	G	103	67	g
8	08	BS or ^H	40	28	(72	48	H	104	68	h
9	09	HT or ^I	41	29)	73	49	I	105	69	i
10	0A	LF or ^J	42	2A	*	74	4A	J	106	6A	j
11	0B	VT or ^K	43	2B	+	75	4B	K	107	6B	k
12	0C	FF or ^L	44	2C	,	76	4C	L	108	6C	l
13	0D	CR or ^M	45	2D	-	77	4D	M	109	6D	m
14	0E	SO or ^N	46	2E	.	78	4E	N	110	6E	n
15	0F	SI or ^O	47	2F	/	79	4F	O	111	6F	o
16	10	DLE or ^P	48	30	0	80	50	P	112	70	p
17	11	DC1 or ^Q	49	31	1	81	51	Q	113	71	q
18	12	DC2 or ^R	50	32	2	82	52	R	114	72	r
19	13	DC3 or ^S	51	33	3	83	53	S	115	73	s
20	14	DC4 or ^T	52	34	4	84	54	T	116	74	t
21	15	NAK or ^U	53	35	5	85	55	U	117	75	u
22	16	SYN or ^V	54	36	6	86	56	V	118	76	v
23	17	ETB or ^W	55	37	7	87	57	W	119	77	w
24	18	CAN or ^X	56	38	8	88	58	X	120	78	x
25	19	EM or ^Y	57	39	9	89	59	Y	121	79	y
26	1A	SUB or ^Z	58	3A	:	90	5A	Z	122	7A	z
27	1B	ESC or ^[59	3B	;	91	5B	[123	7B	{
28	1C	FS or ^\	60	3C	<	92	5C	\	124	7C	
29	1D	GS or ^]	61	3D	=	93	5D]	125	7D	}
30	1E	RS or ^^	62	3E	>	94	5E	^	126	7E	~
31	1F	US or ^_	63	3F	?	95	5F	_	127	7F	DEL

NOTE: The characters with a caret (^) in front of them are called control

characters and are produced by pressing the CTRL key and holding it down while pressing the other key. For example, the ^A, (control A), character is generated by pressing the CTRL and A keys simultaneously.

RECONFIGURING THE KEYPAD

If you have little use for entering numerical data with the numeric keypad at the right of the KAYPRO keyboard but use the CTRL key a great deal, you may want to reconfigure the keypad keys to enable you to activate with one keystroke functions which usually take two.

The reconfiguration changes the keypad codes for a particular disk. You can put one configuration on a word-processing disk; another configuration on a spreadsheet disk; another configuration on a data base disk, etc.

It is done using hexadecimal, but we make it easy by providing the table of decimal-hexadecimal-character codes. Look in the index under "ASCII chart."

Here is the procedure:

1. Make a diagram of the keypad with the changes you want to make. This will help you in the reconfiguration, and, after the reconfiguration, will serve to remind you of the functions you have given the keys.
2. Insert into drive A the CP/M diskette.
3. Insert into drive B the diskette having the program for which you would like to change the keypad configuration.
4. Reset the computer by pressing the reset button on the back panel or by entering a CTRL-C.
5. After the A> prompt, type: CONFIG
Press RETURN.
6. From the main menu select Numerical keypad definitions by typing: 4
7. From the secondary menu, select Change the Numerical keypad settings by typing: 2

On the diagram of the keypad which appears, there will be two sets of numbers on each key. The top number is the number shown on the keypad; the bottom number is its hex equivalent.

8. Follow the instructions on the right of the screen to enter new hex values for the keys you want to change.
9. When you have entered the hex values for the keys you want to change, go to the secondary menu by pressing ESCape.
10. Return to the main menu by pressing ESCape again.
11. Press ESCape one more time.
12. If you want to effect the changes, type: y
13. Press ESCape.
14. When you see the A> prompt, remove the CP/M disk from drive A, and insert the reconfigured disk in drive A.
15. Press the reset button on the back panel of the computer.

Remember, you will have to use either a cold boot or a reset when you bring up a program with a reconfigured keypad to activate the changes.

That's all there is to it. Now, you may want to put your diagram above the keypad until you get used to the new configuration.

PROGRAM TO TURN OFF THE KEYBOARD BEEPER

This program is in the M-BASIC programming language. See your M-BASIC manual for details.

```
10 REM THIS PROGRAM TURNS OFF THE KEYBOARD BEEPER
20 DEFINT A-Z
30 KEYBOARD=5
40 QUIET=8
50 OUT KEYBOARD, QUIET
60 END
```

FCC INFORMATION FOR THE KAYPRO II

This equipment generates and uses radio frequency energy and if not installed and used properly, that is, in strict accordance with the manufacturer's instructions, may cause interference to radio and television reception. It has been type tested and found to comply with the limits for a Class B computing device in accordance with the specifications in Subpart J of Part 15 of FCC Rules, which are designed to provide reasonable protection against such interference in a residential installation. However, there is no guarantee that interference will not occur in a particular installation. If this equipment does cause interference to radio or television, which can be determined by turning the equipment off and on, the user is encouraged to try to correct the interference by one or more of the following measures:

Reorient the receiving antenna.

Relocate the computer with respect to the receiver.

Move the computer away from the receiver.

Plug the computer into a different outlet so that computer and receiver are on different branch circuits.

If necessary, the user should consult the dealer or an experienced radio/television technician for additional suggestions. The user may find the following booklet prepared by the Federal Communications Commission helpful:

"How to Identify and Resolve Radio-TV Interference Problems."

This booklet is available from the U.S. Government Printing Office, Washington, DC 20402, Stock No. 004-000-00345-4.

WARNING: This equipment has been certified to comply with the limits for a Class B computing device, pursuant to Subpart J of Part 15 of FCC Rules. Only peripherals (computer input/output devices, terminals, printers, etc.) certified to comply with the Class B limits may be attached to this computer. Operation with non-certified peripherals is likely to result in interference to radio and TV reception.

FCC INFORMATION FOR THE KAYPRO 4

This equipment generates, uses, and can radiate radio frequency energy and, if not installed and used in accordance with the instruction manual, may cause interference to radio communications. It has been tested and found to comply with the limits for a Class A computing device pursuant to subpart J of Part 15 of FCC Rules, which are designed to provide reasonable protection against such interference when operated in a commercial environment. Operation of this equipment in a residential area is likely to cause interference, in which case the user at his own expense will be required to take whatever measures may be required to correct the interference.

If this computer is used with peripheral devices, such as a printer or modem, then well-shielded cables must be used to preserve the radio interference characteristics.

GLOSSARY

ADDRESS	a number used by the computer to keep track of different memory locations
ASCII	acronym for American Standard Code for Information Interchange, a 7-bit code for representing character data such as letters, punctuation, etc.
BACK UP	to copy information or programs on diskettes as a protective measure
BAUD RATE	the speed of serial communications; BAUD is used generally to mean bits per second; 300 baud would be 300 bits/second or 30 characters per second
BDOS	acronym for Basic Disk Operating System: the section of CP/M that keeps track of disk files
BIOS	acronym for Basic Input/Output System: the section of CP/M that handles the hardware of the KAYPRO
BIT	a binary digit, the smallest piece of information a computer can handle (see BYTE)
BOOT	loading CP/M into the computer's memory from drive A. COLD BOOT occurs when the machine is first turned on or the reset button is pressed; WARM BOOT occurs when you press the CTRL and C keys simultaneously (see CP/M manual for details)
BUFFER	an area of memory set aside for storing and manipulating data associated with I/O devices, such as diskettes and keyboards
BUG	a problem or undesirable side-effect of a computer program, almost always unexpected and unwelcome (see DEBUG).
BYTE	8 bits; the size of a memory location in the KAYPRO; a computer "word". A kilobyte or kbyte is one thousand bytes (1024 bytes, actually)

CCP	acronym for Console Command Processor: the section of CP/M that translates what you type on the keyboard into something the computer can understand
CHIP	slang for an integrated circuit
CONSOLE	the device used for communication between the computer and you. Normally, this is the keyboard and the video display.
CP/M	acronym for Control Program for Microcomputers. The most popular disk operating system for 8080 and Z-80 microcomputers, CP/M keeps track of the files and programs on the floppy disks and facilitates their use.
CPU	acronym for Central Processing Unit; the microprocessor chip
CRT	acronym for Cathode Ray Tube: the "TV" tube used as the video display
DEBUG	to remove mistakes from a computer program (see BUG)
DIR	a built-in CP/M command that gives a list of a disk's files. See AN INTRODUCTION TO CP/M FEATURES AND FACILITIES for details.
DIRECTORY	the list of files on a disk. Most CP/M systems allow 64 different entries in the directory (see DIR and STAT).
FILE	a collection of characters, data, or what-have-you that is stored on a disk. A file can contain a program or information to be used by other programs or a manuscript, etc.
FILENAME	the name of a file, which you see when you list the directory or use when you access a file. The general form for a filename is: B:NAME.MSS The first part (A: or B:) indicates which drive the file is in. The second part is the name, and can be up to eight characters long. The last part is called the extent, is separated from the name by a period, and can be up to three characters long.
FORMAT	the organization of data on a disk — for the KAYPRO, a single side in the double-density soft-sector format consists of 40 tracks per disk with each track divided into 10 sectors.

HARDWARE	the physical parts of the computer and its peripheral equipment, as opposed to SOFTWARE.
HIGH-LEVEL LANGUAGE	a computer programming language that is similar to English or mathematics. S-BASIC and PASCAL, for example, are high-level languages.
INPUT	data put into the computer. By extension, the process or means of putting data into the computer.
LOAD	to take information from a storage medium, such as a disk or tape, and put it into the computer's memory.
MACHINE LANGUAGE	a binary language that a computer can understand, as opposed to either assembly language (see the ASM section of your CP/M manual) or high-level languages like S-BASIC.
MODEM	acronym for MODulation/DEModulation; a device that connects a computer terminal to another computer terminal via a communications link, such as the telephone system. With the KAYPRO, modems are connected directly to the RS-232C connector at the rear of the machine.
OUTPUT	information displayed or used to control devices external to a computer. By extension, the process or means of getting information out of a computer.
PERIPHERAL	any device connected to and used with your computer (e.g., a printer or modem).
PROGRAM	a set of instructions for a computer; the SOFTWARE. When these instructions are in a high-level language like BASIC, they will always have to be converted into a set of low-level or machine language instructions by either an interpreter (M-BASIC) or a compiler (S-BASIC).
PROMPT	a unique character or characters displayed by a program to inform the user that the program requires some instruction or information. In CP/M, the A> is a prompt waiting for the user to enter a command.

RAM	acronym for Random Access Memory; the memory that the computer uses for short-term storage of information and programs. Unlike ROM, the information stored in RAM is changeable and volatile, meaning it will disappear when the power to the computer is turned off.
ROM	acronym for Read Only Memory; the memory that is used for unchanging information and programs. Information stored in ROM is not volatile, and will remain intact regardless of whether the power to the computer is on or off.
SECTOR	a KAYPRO double-density diskette has a format which consists of 10 sectors on each track, with each sector containing 512 bytes of information.
STAT	a program on the CP/M disk that gives the statistics of a disk's files, showing how much space (in kilobytes) each file is using and how much empty space is left on a disk.
SYSGEN	a program on the CP/M disk that transfers CP/M from one disk to another.
TRACK	a ring of information on a diskette. The standard KAYPRO double-density diskette has 40 tracks.
UTILITY	a program often used. For example, PIP is a utility program (details in the CP/M manual) that allows the transfer of files.

INDEX

- ADM-3A 56
- A> prompt 23, 24
- arrow keys , see cursor keys 13
- ASCII characters 57
- assignments, pin 45, 47, 48
- asterisk 35

- backup copies 19
- baud 47
- baud rate 50
- baud rate table 49
- BDOS 32
- BDOS error 24
- beeper 61
- BIOS 32
- boot 23, 24
- brightness 14, 25
- brownouts, electrical 43
- BUSY line 45, 46

- CAPS LOCK key 10
- CCP 32
- CCP prompts 26
- Centronics-type connector 45
- cleaning the computer 44
- cold boot 23
- CONFIG 12
 - for serial printer 49
- Console Command Program 26
- control functions in CP/M 55
- control key 10, 55
- COPY 28
- copying files 37
- copying diskettes 37
- CP/M 32

- CTRL key, see control key 10, 55
- cursor 13
- cursor keys 13

- data storage 15, 17
- data transmission 47
- DELeTe key 11
- DIR 34
- directory 34
- disk drive indicator lights 26
- disk drive protectors 7
- disk drives 7
- diskette, damaged 42
- diskettes 2, 15, 16, 17-20
- display, none 42
- drives 26

- ERA 39
- erasing a file 39
- error message, BDOS 24
- ESCApe key 10
- escape sequences 56
- extent 38

- FCC information 62
- <filename> 22
- file type 21
- files 16, 21
- formatting 30-31

- glossary 63

- handshaking 47-48, 50

- indicator lights 26
- i/o connectors 45
- i/o port addresses 50

KAYPRO.LRN 33
keyboard, attaching 6
keyboard, won't work 43
keyboard beeper, turning off the 61
keypad 12
keypad, configuring 59
keys 10, 11

line feed key 11
line filter 2

maintenance 44
memory 15
memory map 54
modem 47, 49

overwriting the buffer 47

pin assignments 45
PIP 37-38
power, external power conditioner 43
power fluctuations 43
power indicator light 25, 26
power, none 42
power requirements 2
power source, backup 2
printer 32
printer, Centronics-type 45-46
printer, connecting 45
printer, parallel 45
printer, serial 47-48
printer, serial port 47-49
printer, redirection of 47
printer, output 45
program won't load or execute 42
prompt 23

RAM 15
received character available 49
REN 40
renaming a file 40
restricted characters 21
ROM 15
RS-232C connector 47, 48, 50

screen 14
serial output 49
serial port 53
serial port assignments 49
serial printer 47-48
setup 3
software 28
starting the KAYPRO 25
STATistics 35
system port and i/o select 51
symptoms and remedies 41-43

technical information 41
teletype configuration 47
transmit buffer empty 49
troubleshooting 41-43
turning off the KAYPRO 27
TYPE 36

utility files 32
video command protocol 56
video display, none 42

warm boot 23-24
warranty - back of title page
wild card 38
write-protect notch 20

