

norpak NKB4 Software Flow

SCALE
DWN. No
DRN BY JG
CH'D BY CRT

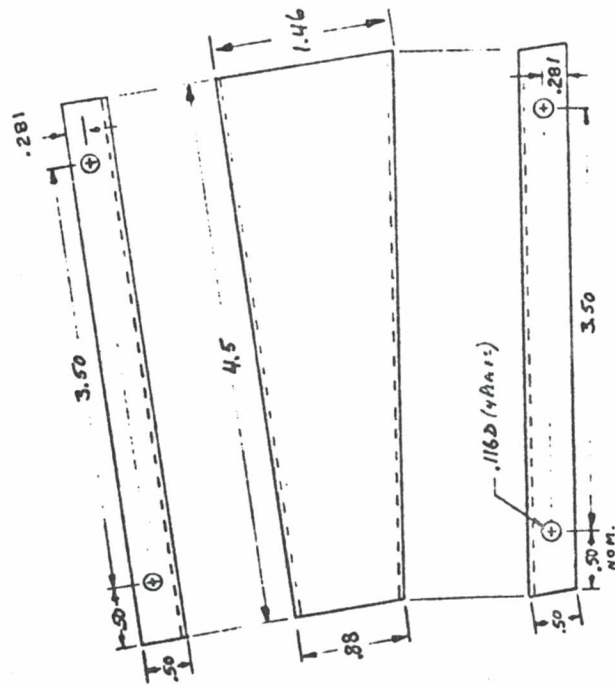

NOTE: 2 PC. REQ'D, SECOND PART
 TO BE MIRROR IMAGE OF
 ABOVE DRAWING

MTL: .064 AL

FINISH: IRRIDITE

NOT TO SCALE

norpak

TITLE Keyboard
 Mounting Bracket B

REV

B

DR	CRT	DATE	PROJ
CK	JG	10/12/77	DWO
ENG	CRT		REF

D1255-4

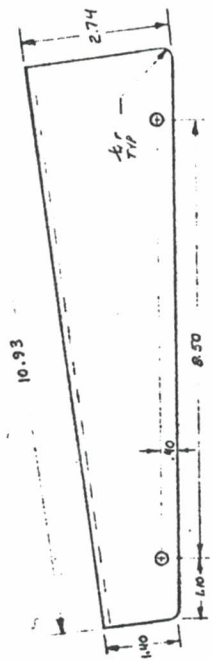
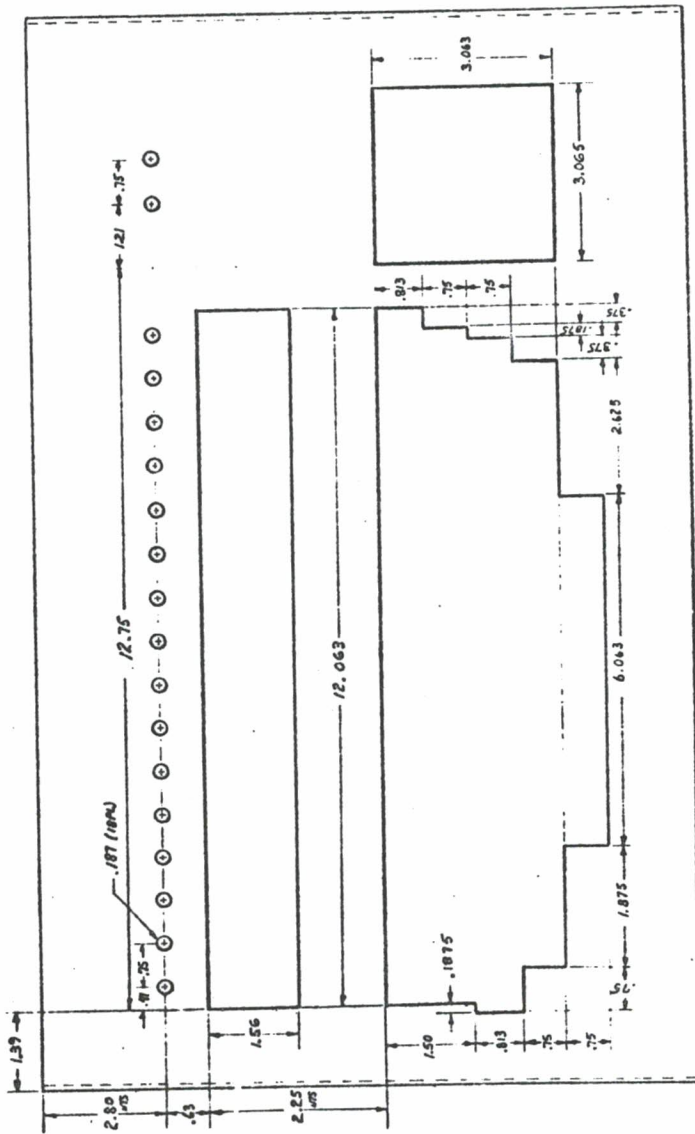

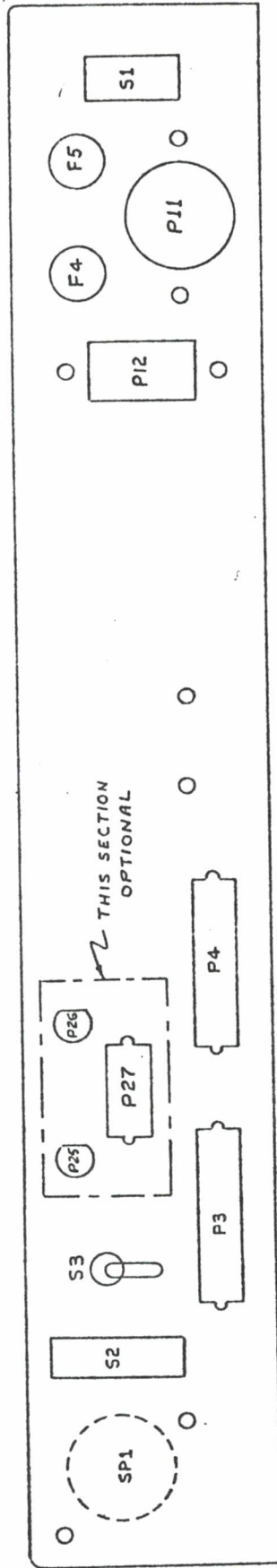
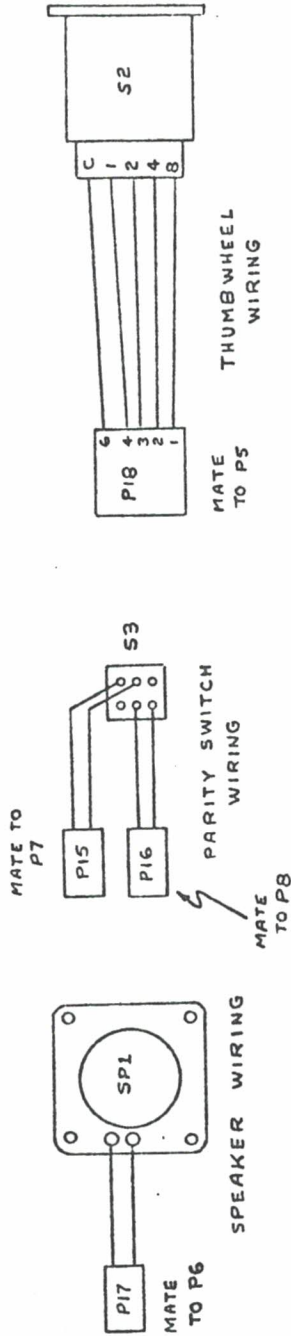
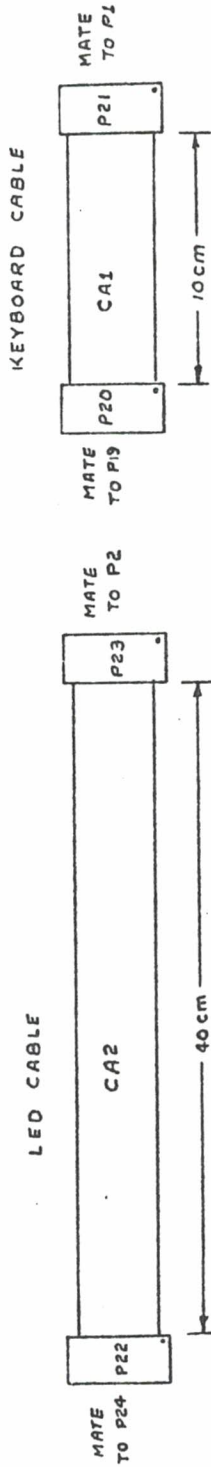

norpak

NKB4 Keyboard (rear panel view)

SCALE NTS
 DWN. NO. D1256-
 CH'D BY CRT
 DATE 08/08/78

MAT'L No. REG'D CLASS

DRN BY JG

CH'D BY CRT

DATE 08/08/78

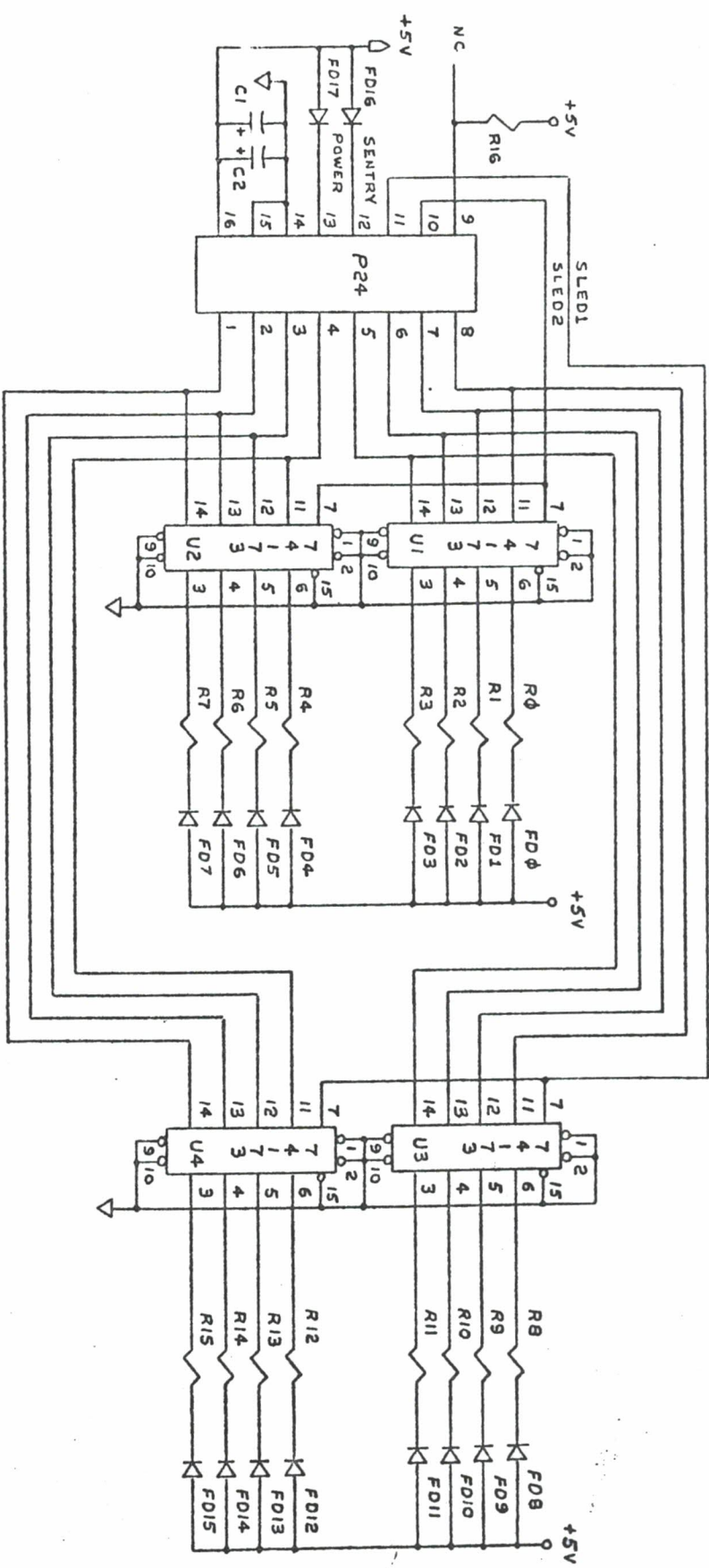
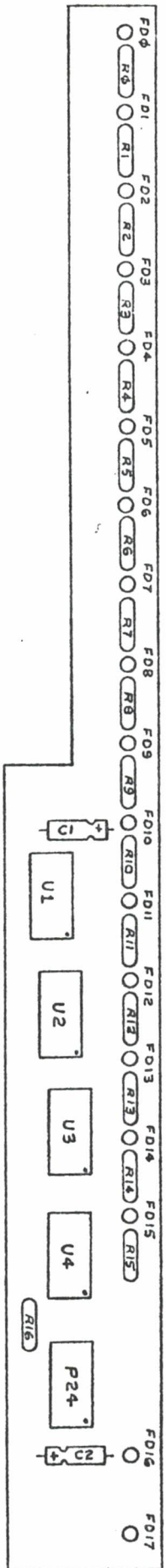

norpa

NKB4 Led Panel

DRN BY JC
 CHD BY CR
 DATE 09/08/78
 SCALE
 D1258-3

NO. RECD CLASS

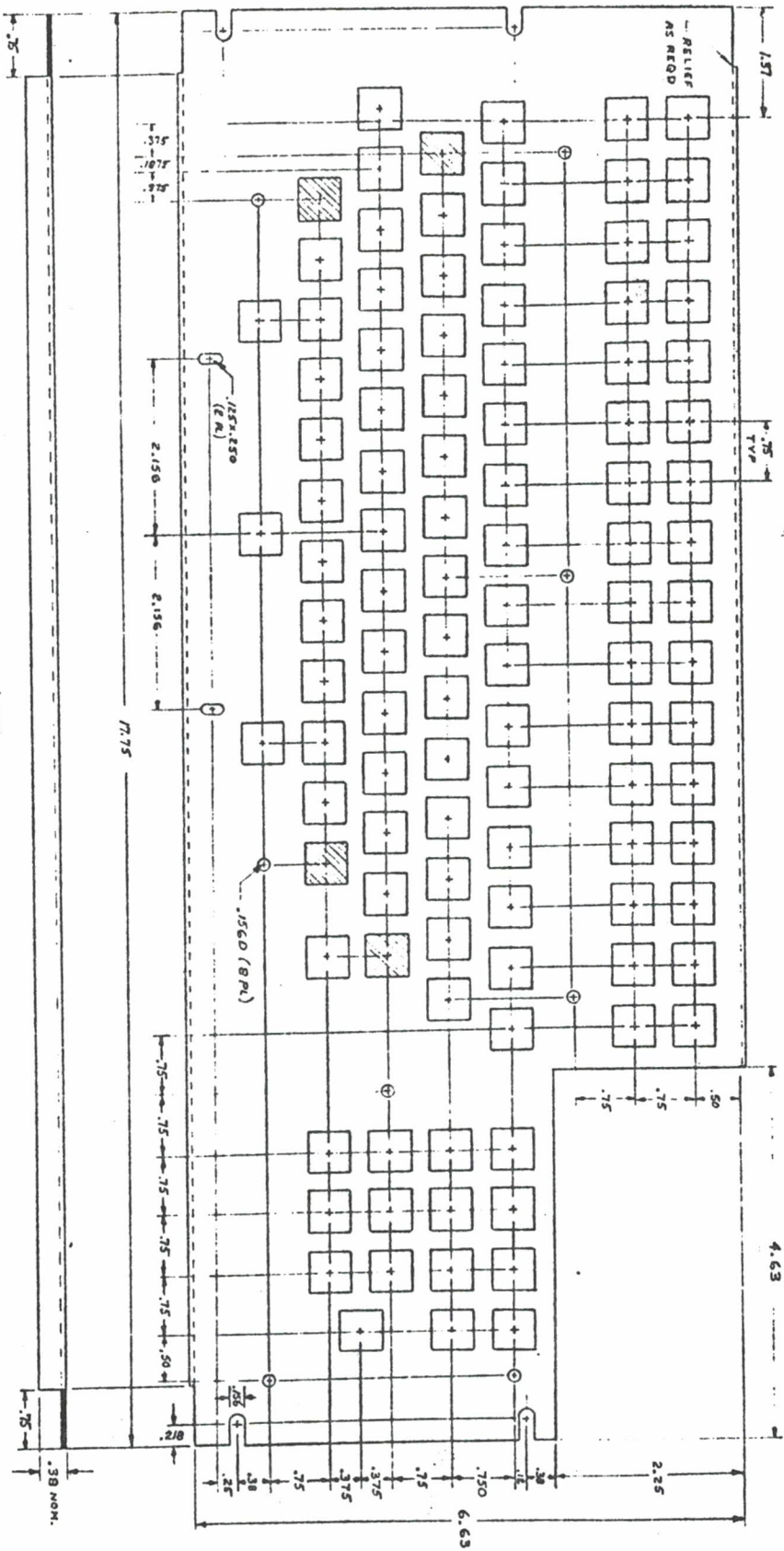

NOTE

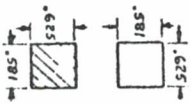

PUNCH ORIENTATION FOR UNSHADED HOLES

PUNCH ORIENTATION FOR SHADED HOLES

MTL: ORAL GOGITG
FINI: AT BLACK ENAMEL

norpak

TITLE **NKB4**
Switch Plate

REV **A**

OR	CRT	DATE	PROJ	DWG	DIA
CR	JG	11/05/78			
BRG	CRT		REV		

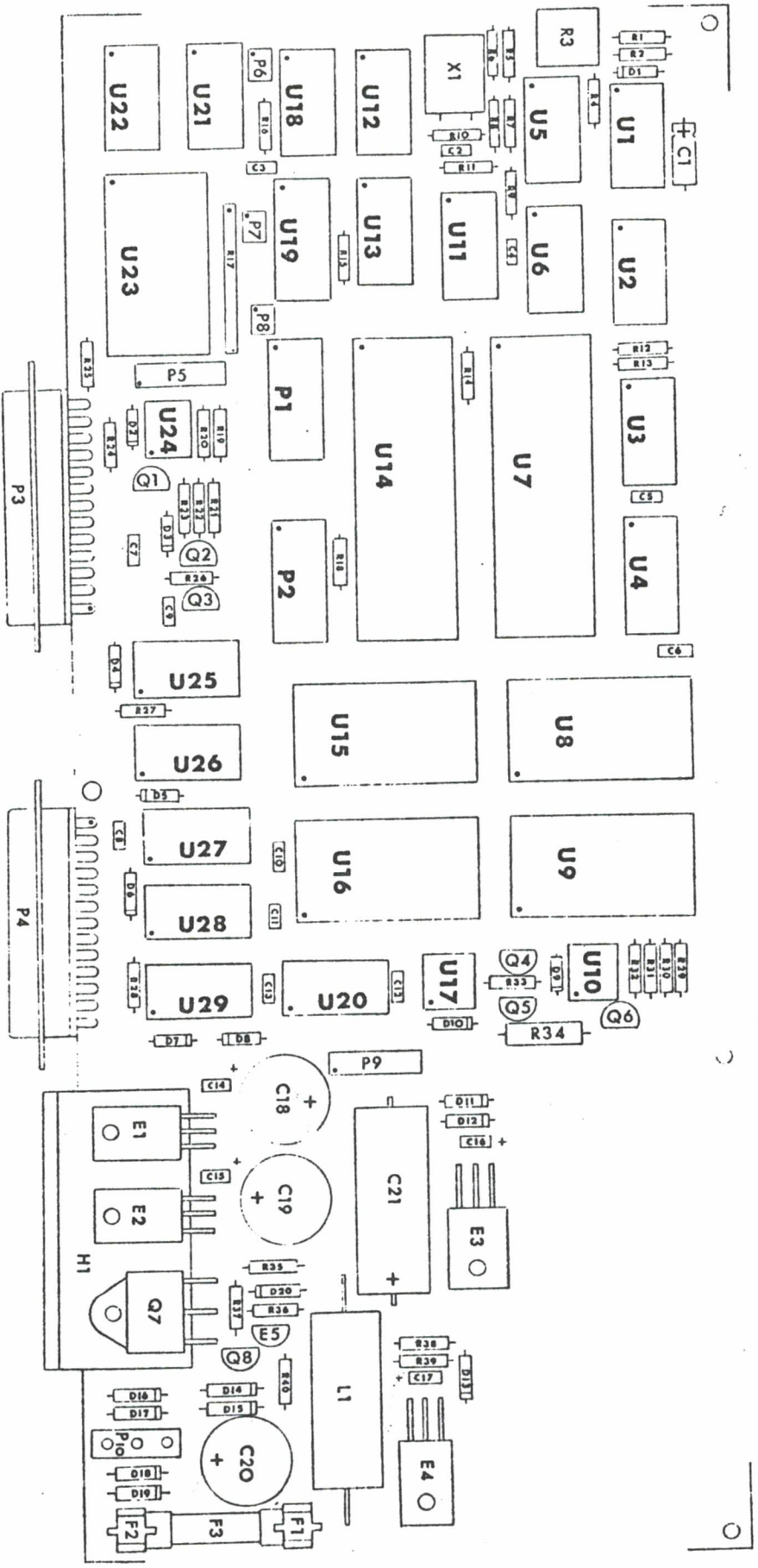

norpak

NKB4 Controller

DATE 28/05/78 D1256-2

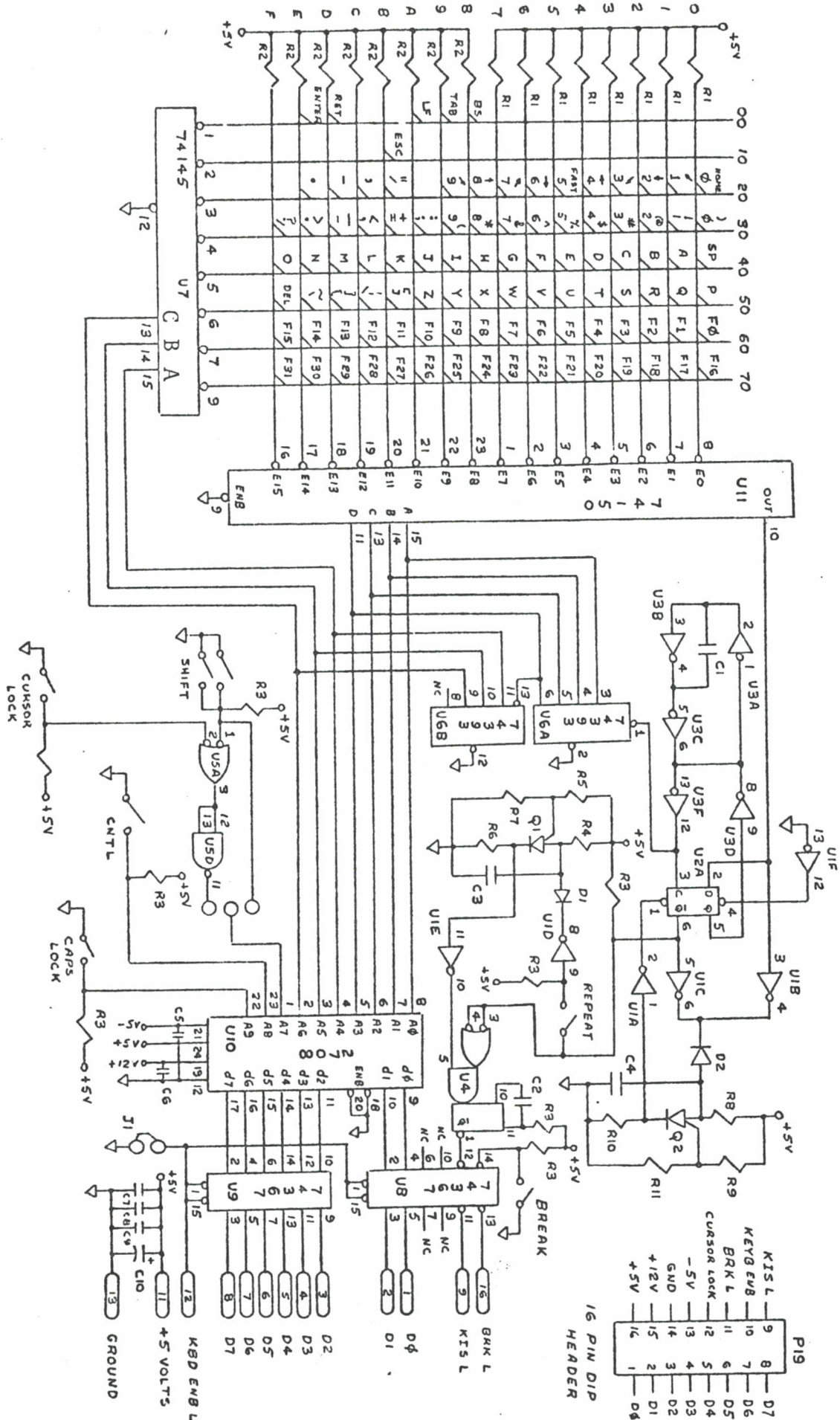

norpar

NKBA Keyboard

DRN BY JG
 CHD BY CRT
 DATE 20/05/78
 ID 1258-1

norpak

NKB4 Keyboard

MAT'L

NR. REQ'D

CLASS

DATE

22/05/78

256-1

DRN. BY JG

NTS

CHK'D BY CRT

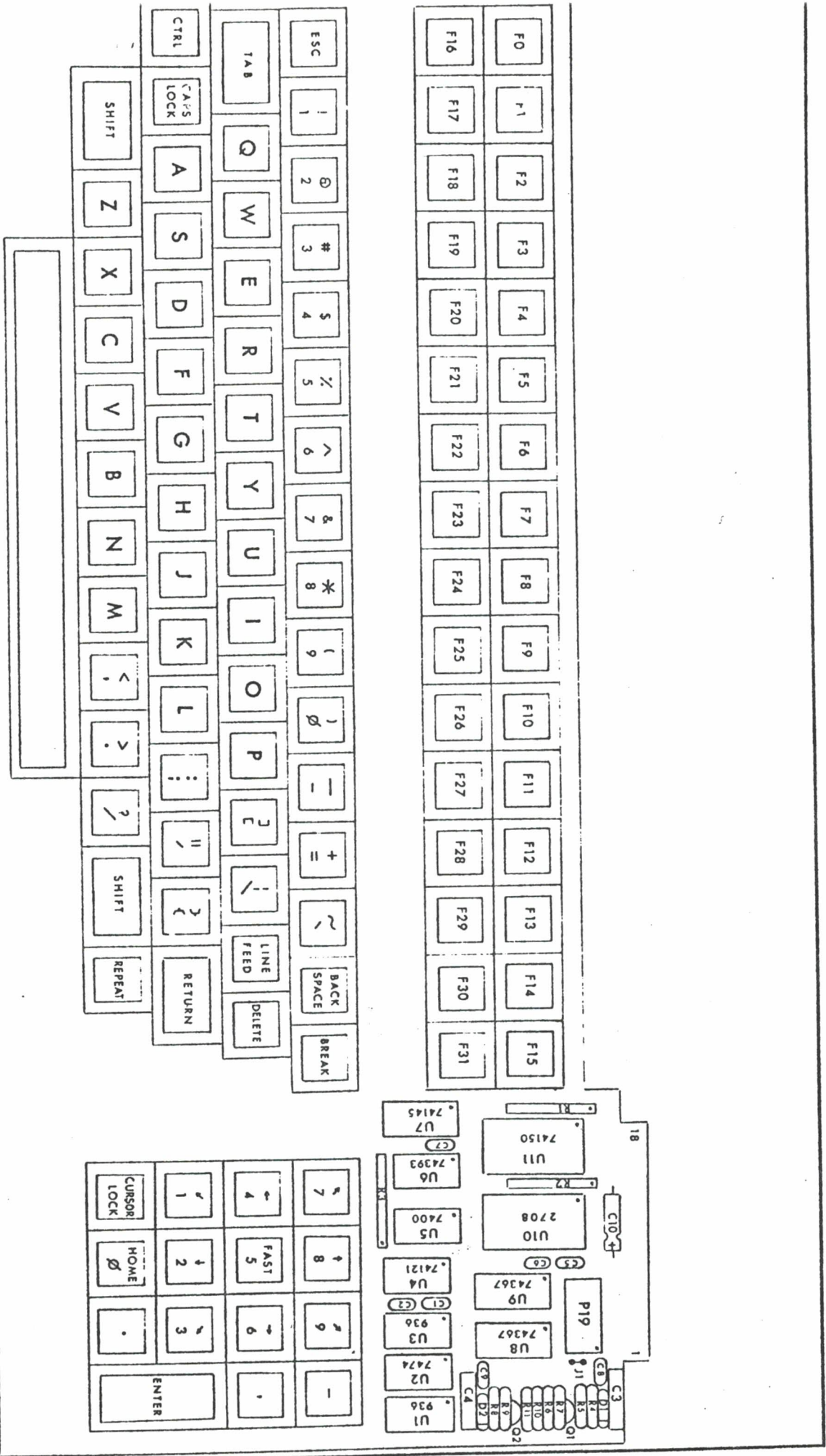

Orpak

NKB4 Controller

DATE 08/08/78 101258-2

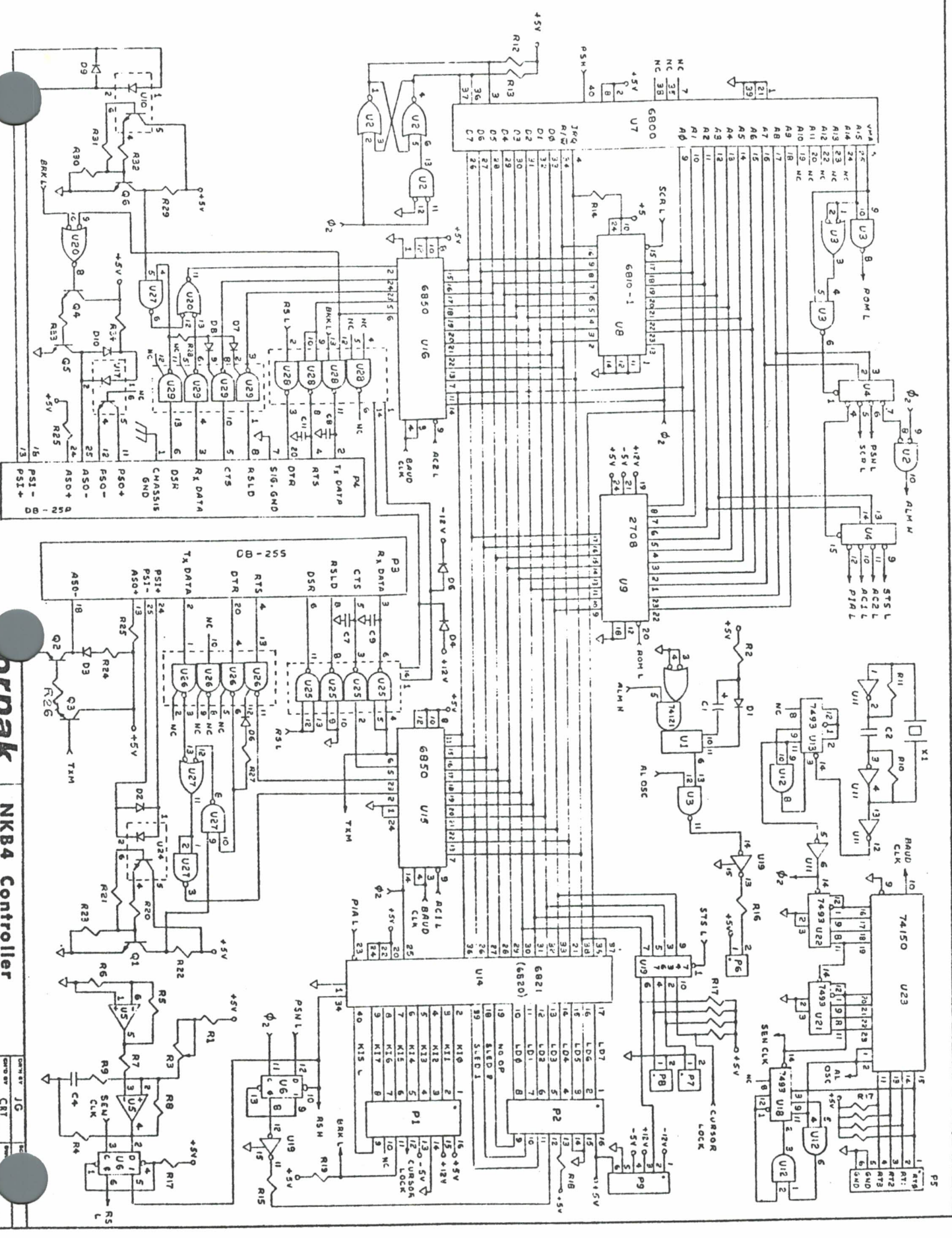

P5